

# Low Noise Amplifier

**ZX60-P162LN+**

50Ω

0.7 to 1.6 GHz

## The Big Deal

- Ultra Low Noise Figure, 0.5 dB typ.
- High Dynamic Range



Case Style: GC957

## Product Overview

The ZX60-P162LN+ (RoHS compliant) uses Mini-Circuits' E-PHEMT technology to offer ultra low noise figure over a broad frequency range and high IP3. Housed in a rugged, cost effective unibody chassis, this amplifier supports a wide variety of applications requiring moderate power output, low distortion and 50 ohm matched input/output ports.

## Key Features

Feature	Advantages
Ultra Low Noise Figure, 0.5 dB at 1GHz	Outstanding world class noise figure performance.
High IP3 vs. DC power consumption 29.9 dBm typical at 1 GHz	Combining Low Noise and High IP3 makes this model ideal for use in Low Noise Receiver Front End (RFE)
Max. Input Power, +25 dBm	Ruggedized design operates to high input powers often seen at receiver inputs.
Very Small Size, 0.75" x 0.75"	The unique unibody size and construction enable the ZX60-P162LN+ to be used in extremely compact connectorized applications.

**Notes**

A. Performance and quality attributes and conditions not expressly stated in this specification document are intended to be excluded and do not form a part of this specification document.

B. Electrical specifications and performance data contained in this specification document are based on Mini-Circuit's applicable established test performance criteria and measurement instructions.

C. The parts covered by this specification document are subject to Mini-Circuits standard limited warranty and terms and conditions (collectively, "Standard Terms"); Purchasers of this part are entitled to the rights and benefits contained therein. For a full statement of the Standard Terms and the exclusive rights and remedies thereunder, please visit Mini-Circuits' website at [www.minicircuits.com/MCLStore/terms.jsp](http://www.minicircuits.com/MCLStore/terms.jsp)

# Coaxial Low Noise Amplifier

## ZX60-P162LN+

50Ω 0.7 to 1.6 GHz

### Features

- Low Noise Figure, 0.5 dB at 1 GHz
- High IP3, 29.9 dBm typ. at 1 GHz
- High Pout, P1dB, +19.9 dBm typ. at 1 GHz
- High Gain, 22.5 dB typ. at 1 GHz

### Applications

- Base station infrastructure
- Portable wireless
- GPS
- GSM
- Airborne radar



Case Style: GC957

Connectors	Model	Price	Qty.
SMA	ZX60-P162LN+	\$54.95 ea.	(1-9)

### +RoHS Compliant

The +Suffix identifies RoHS Compliance. See our web site for RoHS Compliance methodologies and qualifications

### Electrical Specifications at 25°C and 4.0V unless noted

Parameter	Condition (GHz)	Min.	Typ.	Max.	Units
Frequency Range		0.7		1.6	GHz
Noise Figure	0.7		0.65		dB
	0.8		0.47		
	1.0		0.52	0.95	
	1.3		0.56		
	1.6		0.74		
Gain	0.7		24.1		dB
	0.8		23.8		
	1.0	20.9	22.5	24.5	
	1.3		20.5		
	1.6		18.5		
Output Power @ 1 dB compression	0.7		19.2		dBm
	0.8		19.9		
	1.0	17.5	19.9		
	1.3		19.7		
	1.6		19.5		
Output IP3	0.7		29.0		dBm
	0.8		29.8		
	1.0	28.0	29.9		
	1.3		30.2		
	1.6		29.6		
Input VSWR	0.7		2.18		dB
	0.8		1.63		
	1.0		1.19		
	1.3		1.23		
	1.6		1.39		
Output VSWR	0.7		1.57		dB
	0.8		1.42		
	1.0		1.38		
	1.3		1.65		
	1.6		2.11		
Directivity (Isolation-Gain)	0.7 - 1.6		8.0		dB
DC Supply Voltage		3.8	4.0	4.2	V
Supply Current		44	52	60	mA

### Notes

- Performance and quality attributes and conditions not expressly stated in this specification document are intended to be excluded and do not form a part of this specification document.
- Electrical specifications and performance data contained in this specification document are based on Mini-Circuit's applicable established test performance criteria and measurement instructions.
- The parts covered by this specification document are subject to Mini-Circuits standard limited warranty and terms and conditions (collectively, "Standard Terms"); Purchasers of this part are entitled to the rights and benefits contained therein. For a full statement of the Standard Terms and the exclusive rights and remedies thereunder, please visit Mini-Circuits' website at [www.minicircuits.com/MCLStore/terms.jsp](http://www.minicircuits.com/MCLStore/terms.jsp)



[www.minicircuits.com](http://www.minicircuits.com) P.O. Box 35166, Brooklyn, NY 11235-0003 (718) 934-4500 sales@minicircuits.com

REV. OR  
M135235  
ED-14715  
ZX60-P162LN+  
CW/TH/CP  
130710  
Page 2 of 4

## Maximum Ratings

Parameter	Ratings
Operating Temperature	-40°C to 85°C Case
Storage Temperature	-55°C to 100°C
DC Voltage	5.5 V
Input RF Power (no damage) Vd=4V	25 dBm
Power Consumption	0.55 W

Permanent damage may occur if any of these limits are exceeded.

## Outline Drawing

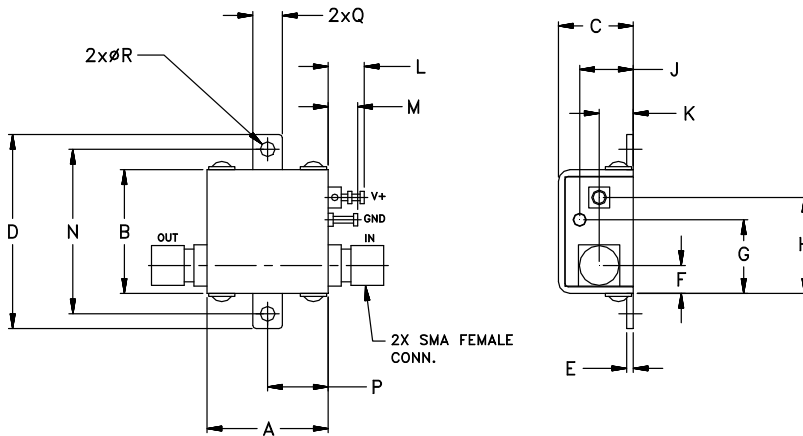

## Outline Dimensions (inch)

A	B	C	D	E	F	G	H	J	K	L	M	N	P	Q	R	wt
.74	.75	.46	1.18	.04	.17	.45	.59	.33	.21	.22	.18	1.00	.37	.18	.106	grams
18.80	19.05	11.68	29.97	1.02	4.32	11.43	14.99	8.38	5.33	5.59	4.57	25.40	9.40	4.57	2.69	23.0

### Notes

- Performance and quality attributes and conditions not expressly stated in this specification document are intended to be excluded and do not form a part of this specification document.
- Electrical specifications and performance data contained in this specification document are based on Mini-Circuit's applicable established test performance criteria and measurement instructions.
- The parts covered by this specification document are subject to Mini-Circuits standard limited warranty and terms and conditions (collectively, "Standard Terms"); Purchasers of this part are entitled to the rights and benefits contained therein. For a full statement of the Standard Terms and the exclusive rights and remedies thereunder, please visit Mini-Circuits' website at [www.minicircuits.com/MCLStore/terms.jsp](http://www.minicircuits.com/MCLStore/terms.jsp)



FREQUENCY (MHz)	GAIN (dB)	DIRECTIVITY (dB)	VSWR (:1)		POUT at 1dB COMPR. (dBm)	NOISE FIGURE (dB)	OUTPUT IP3 (dBm)
			IN	OUT			
700.00	24.09	13.78	2.19	1.58	19.2	0.7	29.0
800.00	23.78	13.74	1.64	1.43	19.9	0.5	29.8
900.00	23.17	14.08	1.35	1.37	20.0	0.6	30.2
1000.00	22.49	14.69	1.19	1.38	19.9	0.5	29.9
1100.00	21.81	15.35	1.09	1.44	19.9	0.6	30.3
1200.00	21.12	16.12	1.16	1.53	20.2	0.6	30.4
1300.00	20.46	16.65	1.23	1.65	19.7	0.6	30.2
1400.00	19.81	17.42	1.29	1.80	19.6	0.7	29.8
1500.00	19.16	18.07	1.34	1.95	19.3	0.6	29.8
1600.00	18.53	18.84	1.40	2.13	19.5	0.7	29.6

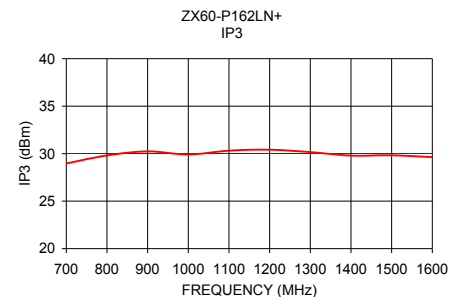
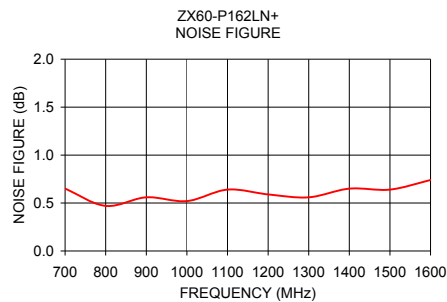
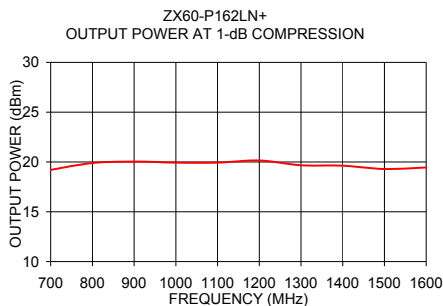
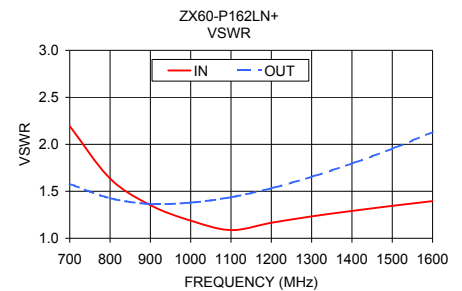
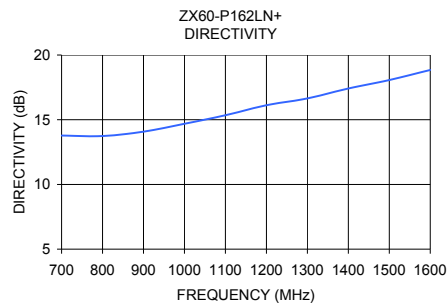
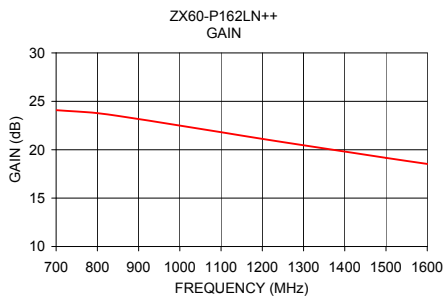

**Notes**

- A. Performance and quality attributes and conditions not expressly stated in this specification document are intended to be excluded and do not form a part of this specification document.
- B. Electrical specifications and performance data contained in this specification document are based on Mini-Circuit's applicable established test performance criteria and measurement instructions.
- C. The parts covered by this specification document are subject to Mini-Circuits standard limited warranty and terms and conditions (collectively, "Standard Terms"); Purchasers of this part are entitled to the rights and benefits contained therein. For a full statement of the Standard Terms and the exclusive rights and remedies thereunder, please visit Mini-Circuits' website at [www.minicircuits.com/MCLStore/terms.jsp](http://www.minicircuits.com/MCLStore/terms.jsp)

