

Coaxial Frequency Mixer

Level 17 (LO Power +17 dBm) 1400 to 1900 MHz

ZP-11AH+ ZP-11AH



BNC version shown
CASE STYLE: GG60

Maximum Ratings

Operating Temperature	-55°C to 100°C
Storage Temperature	-55°C to 100°C
RF Power	200mW
IF Current	40mA
Permanent damage may occur if any of these limits are exceeded.	

Coaxial Connections

LO	L
RF	R
IF	X

Features

- low conversion loss, 7.30 dB typ.
- good L-R isolation, 35 dB typ.
- rugged shielded case

Applications

- UHF
- GPS
- instrumentation
- defense communication

Connectors	Model	Price	Qty.
BNC	ZP-11AH+	\$49.95 ea.	(1-9)
SMA	ZP-11AH-S(+)	\$54.95 ea.	(1-9)

+ RoHS compliant in accordance with EU Directive (2002/95/EC)

The +Suffix identifies RoHS Compliance. See our web site for RoHS Compliance methodologies and qualifications.

Electrical Specifications

FREQUENCY (MHz)		CONVERSION LOSS (dB)		LO-RF ISOLATION (dB)		LO-IF ISOLATION (dB)	
LO/RF	IF	\bar{X}	σ	Typ.	Min.	Typ.	Min.
$f_L - f_U$			Total Range Max.				
1400-1900	40-500	7.30	0.28	9.0	35	25	30
							15

1 dB COMP: +14 dBm typ.

Outline Drawing

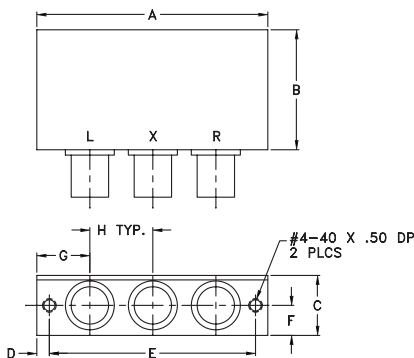

Outline Dimensions (inch/mm)

A	B	C	D	E	F	G	H	wt
2.31	1.20	.60	.125	2.062	.30	.53	.63	grams
58.67	30.48	15.24	3.18	52.37	7.62	13.46	16.00	75.0

Typical Performance Data

Frequency (MHz)		Conversion Loss (dB)	Isolation L-R (dB)	Isolation L-I (dB)	VSWR RF Port (:1)	VSWR LO Port (:1)
RF	LO	LO +17dBm	LO +17dBm	LO +17dBm	LO +17dBm	LO +17dBm
1400.00	1350.00	7.77	31.27	32.09	2.14	2.49
1439.47	1359.47	7.67	30.76	31.93	1.96	2.36
1478.95	1428.97	7.43	30.37	32.04	1.78	2.40
1492.11	1442.11	7.32	30.35	32.12	1.73	2.42
1505.26	1455.26	7.19	30.39	32.21	1.63	2.40
1544.74	1494.74	7.04	30.61	31.36	1.47	2.41
1571.05	1521.05	6.98	30.75	30.93	1.37	2.43
1584.21	1534.21	6.93	30.78	30.41	1.35	2.40
1623.68	1573.68	6.83	30.74	29.48	1.30	2.39
1663.16	1613.16	6.76	30.90	28.37	1.25	2.39
1676.32	1626.32	6.70	30.97	28.01	1.24	2.39
1702.63	1652.63	6.67	30.92	27.27	1.22	2.37
1742.11	1692.11	6.61	31.00	26.47	1.20	2.38
1768.42	1718.42	6.63	31.24	26.03	1.19	2.38
1781.58	1731.58	6.59	31.22	25.77	1.19	2.37
1821.05	1771.05	6.59	30.92	25.12	1.21	2.36
1860.53	1810.53	6.68	30.65	24.63	1.25	2.37
1873.68	1823.68	6.67	30.61	24.43	1.27	2.35
1886.84	1836.84	6.74	30.60	24.19	1.29	2.33
1900.00	1850.00	6.79	30.64	24.07	1.31	2.31

Electrical Schematic

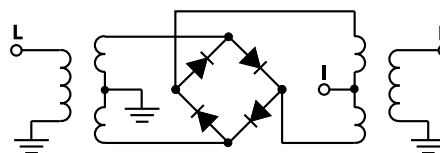

Mini-Circuits
ISO 9001 ISO 14001 AS 9100 CERTIFIED

For detailed performance specs & shopping online see web site

P.O. Box 350166, Brooklyn, New York 11235-0003 (718) 934-4500 Fax (718) 332-4661 The Design Engineers Search Engine Provides ACTUAL Data Instantly at minicircuits.com

Notes: 1. Performance and quality attributes and conditions not expressly stated in this specification sheet are intended to be excluded and do not form a part of this specification sheet. 2. Electrical specifications and performance data contained herein are based on Mini-Circuit's applicable established test performance criteria and measurement instructions. 3. The parts covered by this specification sheet are subject to Mini-Circuit's standard limited warranty and terms and conditions (collectively, "Standard Terms"); Purchasers of this part are entitled to the rights and benefits contained therein. For a full statement of the Standard Terms and the exclusive rights and remedies thereunder, please visit Mini-Circuit's website at www.minicircuits.com/MCLStore/terms.jsp.

REV. B
M98898
ZP-11AH
DJ/TD/CP/AM
100205
Page 1 of 2

Performance Charts

ZP-11AH+ ZP-11AH

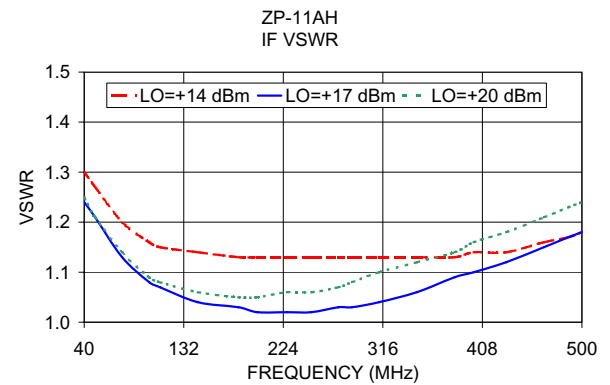
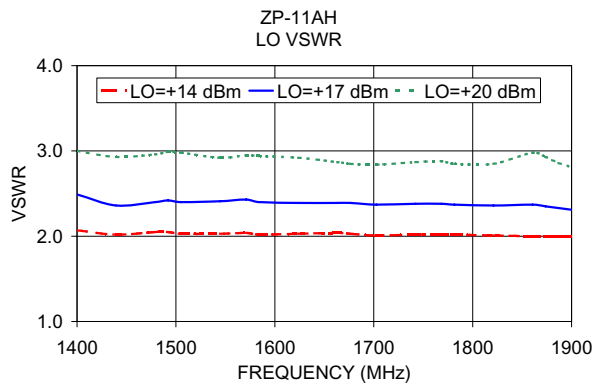
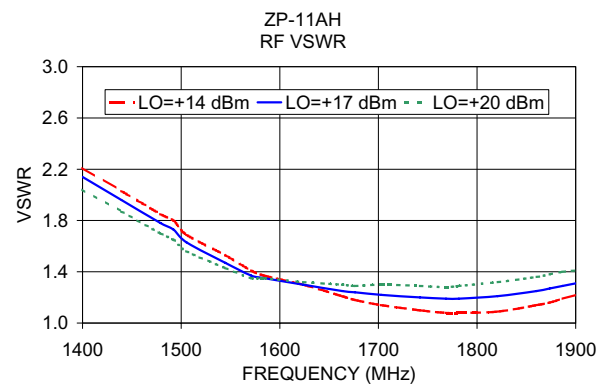
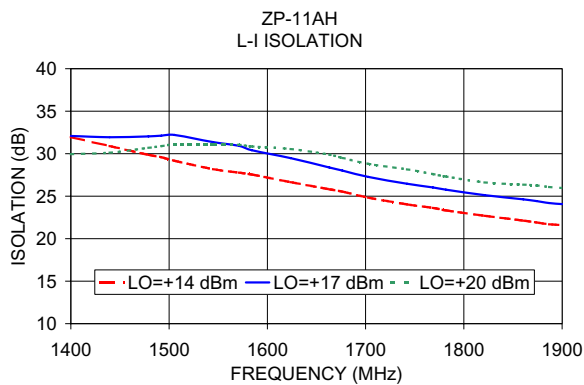
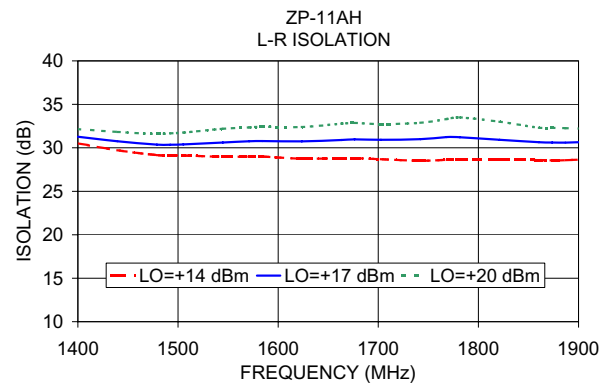
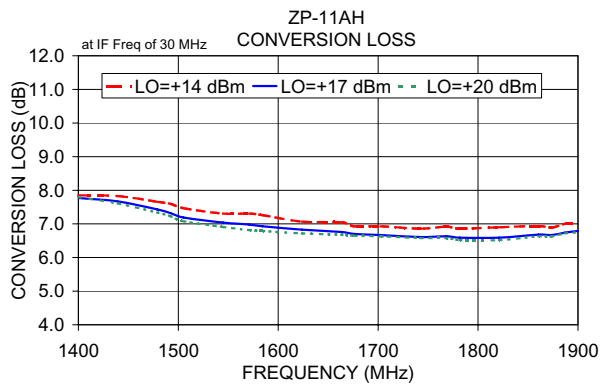

P.O. Box 350166, Brooklyn, New York 11235-0003 (718) 934-4500 Fax (718) 332-4661 *The Design Engineers Search Engine* Provides ACTUAL Data Instantly at minicircuits.com

IF/RF MICROWAVE COMPONENTS

For detailed performance specs & shopping online see web site

Notes: 1. Performance and quality attributes and conditions not expressly stated in this specification sheet are intended to be excluded and do not form a part of this specification sheet. 2. Electrical specifications and performance data contained herein are based on Mini-Circuit's applicable established test performance criteria and measurement instructions. 3. The parts covered by this specification sheet are subject to Mini-Circuit's standard limited warranty and terms and conditions (collectively, "Standard Terms"); Purchasers of this part are entitled to the rights and benefits contained therein. For a full statement of the Standard Terms and the exclusive rights and remedies thereunder, please visit Mini-Circuit's website at www.minicircuits.com/MCLStore/terms.jsp.