

### The Big Deal:

- Excellent Combination of gain, P1dB, IP3 and NF
- Flat Gain Response:  
± 0.9 dB over 3300-3800 MHz
- 50Ω Input and Output:  
no External Components Required



CASE STYLE: DL1020

### Product Overview:

YSF-382+ is an advanced amplifier module in a Mini-Circuits System In Package **MSiP™**. This module is fully matched to 50Ω in/out impedance and has built-in Input & Output DC block capacitors. It is enclosed in a 5 x 6 mm MCLP plastic package. The YSF-382+ uses E-PHEMT technology enabling it to work with a single positive supply voltage.

### Key Features

Feature	Advantages
Gain Flatness ± 0.9dB	The YSF-382+ provides outstanding gain flatness over the full International WIMAX communications band (3300-3800 MHz) making this ideal for use in applications where gain-flatness and repeatability are critical performance requirements.
Medium Gain: 15dB	The YSF-382+ is a two-stage design with internal feedback and bias to provide flat 15 dB nominal gain, supporting applications where a single gain block must overcome large system losses such as long cable runs and lossy components.
Strong Combination of Performance	The YSF-382+ provides a strong combination of performance parameters including high gain (15 dB), high IP3 (+36 dBm) and P1dB (+20 dBm) and low noise figures (2.5 dB) that are difficult to achieve in a single stage design and available only in the YSF amplifier series.
Integrated Matching, DC Blocking and Bias in Small Package	The YSF-382+ includes all support circuits including: Matching, Bias and DC Blocking, all integrated into a single 5x6mm package making the total footprint equal to or smaller than most solutions.
Excellent Return Loss	The YSF-382+ includes integrated input and output matching and bias circuits to make this amplifier a simple, complete drop-in solution. The matching circuits provide good output return loss (11dB), and are designed to give optimal P1dB and IP3 performance in a 50Ω environment.
High Reverse Isolation	With 28 dB of reverse isolation – the YSF-382+ is an ideal gain block for use in integrated systems to minimize VSWR interactions resulting from cascading highly reflective components such as sharp filters.

# Flat Gain Amplifier

## 3.3-3.8 GHz

### Product Features

- Matched 50-ohm surface mount amplifier
- Medium gain, 15 dB typ.
- Up to +20 dBm typ. output power
- High IP3, +36 dBm
- Low Noise Figure, 2.5 dB typ.
- High directivity, 28 dB isolation
- Internal Input & Output DC Block
- Separate terminal for DC



### YSF-382+

CASE STYLE: DL1020  
PRICE: \$2.49 ea. QTY. (20)

**+ RoHS compliant in accordance with EU Directive (2002/95/EC)**

*The +Suffix has been added in order to identify RoHS Compliance. See our web site for RoHS Compliance methodologies and qualifications.*

### Typical Applications

- WiMax
- Portable Wireless
- Receivers & transmitters
- Radar

### General Description

YSF-382+ is an advanced amplifier module in a Mini-Circuits System In Package **MSiP™**. This module is fully matched to 50Ω in/out impedance and has built-in Input & Output DC block capacitors. It is enclosed in a 5 x 6 mm MCLP plastic package. The YSF-382+ uses E-PHEMT\* technology enabling it to work with a single positive supply voltage.

### simplified schematic and pad description

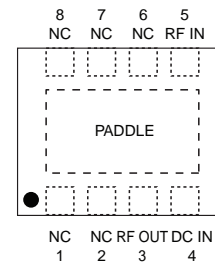
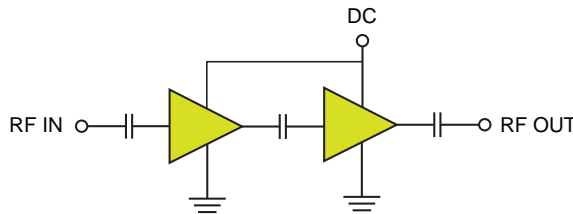

Function	Pad Number	Description
RF-IN	5	RF Input
RF-OUT	3	RF Output
DC	4	DC Supply
GND	Paddle	Connected to ground
NOT USED	1,2,6,7,8	No internal connection

\*Enhancement mode Pseudomorphic High Electron Mobility Transistor

Electrical Specifications<sup>(1)</sup> at 25°C, Zo=50Ω unless noted

Parameter	Condition (MHz)	Min.	Typ.	Max.	Units
Frequency Range		3300		3800	MHz
Gain	3300	14.5	16.0	19.0	dB
	3600	13.0	14.5	17.0	
	3800	12.5	14.0	17.0	
Gain Flatness			0.9		± dB
Input Return Loss	3300		17.5		dB
	3600	10.00	14.5		
	3800		13.1		
Output Return Loss	3300		10.0		dB
	3600	7.0	10.5		
	3800		11.0		
Reverse Isolation			28.0		dB
Output Power @1 dB compression	3300		20.0		dBm
	3600		20.0		
	3800	18.0	20.0		
Output Power @3 dB compression	3300		21.0		dBm
	3600		21.0		
	3800		21.0		
Output IP3	3300		36.0		dBm
	3600	31.0	36.0		
	3800		36.0		
Noise Figure	3300		2.5	3.5	dB
	3600		2.5		
	3800		2.6		
Device Operating Voltage			5		V
Device Operating Current			118	145	mA
Device Current Variation vs. Temperature <sup>(2)</sup>			2		μA/°C
Device Current Variation vs Voltage			0.002		mA/mV
Thermal Resistance, junction-to-ground lead <sup>(3)</sup>			56		°C/W

<sup>(1)</sup> Measured on Mini-Circuits Characterization test board TB-589+. See Characterization Test Circuit (Fig. 1)

<sup>(2)</sup> Δ(+85°C to -45°C)

<sup>(3)</sup> Thermal Resistance=  $\frac{\text{Hot spot temperature} - \text{Ground lead temperature}}{\text{Power Dissipation}}$

## Absolute Maximum Ratings

Parameter	Ratings	Units
Operating Temperature <sup>(4)</sup>	-40 to 85	°C
Storage Temperature	-65 to 150	°C
DC Voltage on Pad 4	7	V
Power Dissipation	1.5	W
Input Power	21	dBm

Note: Permanent damage may occur if any of these limits are exceeded. These ratings are not intended for continuous normal operation.

<sup>(4)</sup> Case is defined as ground paddle.

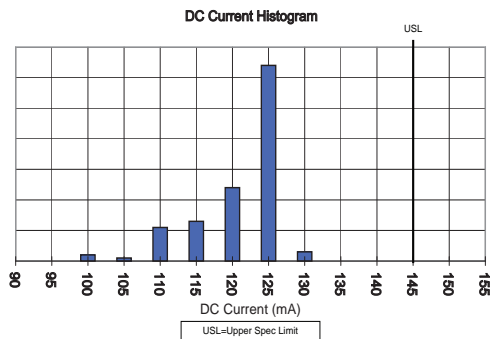

### Characterization Test Circuit

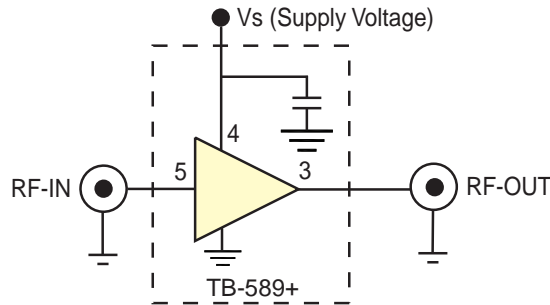

**Fig 1.** Block Diagram of Test Circuit used for characterization. (DUT soldered on Mini-Circuits Characterization Test Fixture TB-589+) Gain, Return loss, Output power at 1dB compression (P1 dB), Output IP3 (OIP3) and Noise Figure measured using Agilent's N5242A PNA-X microwave network analyzer.

**Conditions:**

1. Gain: Pin= -25dBm
2. Output IP3 (OIP3): Two tones, spaced 10 MHz apart, 2.5 dBm/tone at output.

### Recommended Application Circuit



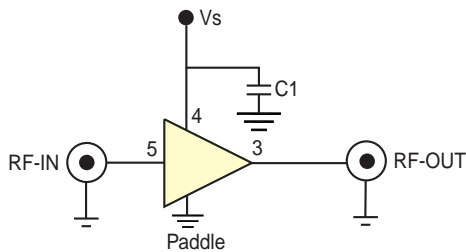



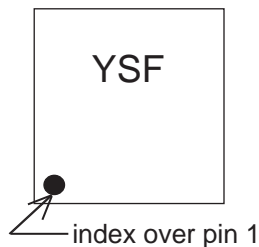

(refer to evaluation board for PCB Layout and component values)



**Fig 2.** Recommended Application Circuit

### Product Marking



Additional Detailed Technical Information <small>(additional information is available on our web site. To access this information enter the model number on our web site home page)</small>		
<b>Performance Data</b>	Data Table	
	Swept Graphs	
	S-Parameter (S2P Files) Data Set (.zip file)	
<b>Case Style</b>	DL1020 <i>Plastic package, exposed paddle, lead finish: tin/silver/nickel</i>	
<b>Tape &amp; Reel</b>	F68	
<b>Suggested Layout for PCB Design</b>	PL-335	
<b>Evaluation Board</b>	TB-589-6+	
<b>Environmental Ratings</b>	ENV08T1	

**ESD Rating**

Human Body Model (HBM): Class 1A in accordance with ANSI/ESD STM 5.1 - 2001

Machine Model (MM): Class M1 (25V) in accordance with ANSI/ESD STM5.2-1999



**Attention**  
 Observe precautions  
 for handling electrostatic  
 sensitive devices

**MSL Rating**

Moisture Sensitivity: MSL1 in accordance with IPC/JEDEC J-STD-020D

**MSL Test Flow Chart**

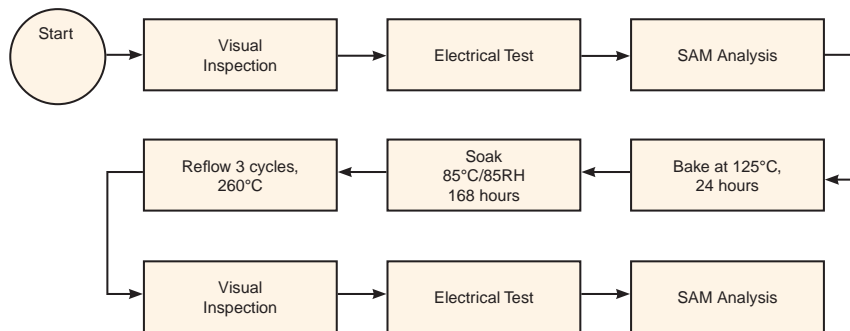

For detailed performance specs & shopping online see web site

P.O. Box 350166, Brooklyn, New York 11235-0003 (718) 934-4500 Fax (718) 332-4661 The Design Engineers Search Engine  Provides ACTUAL Data Instantly at [minicircuits.com](http://minicircuits.com)

**Notes:** 1. Performance and quality attributes and conditions not expressly stated in this specification sheet are intended to be excluded and do not form a part of this specification sheet. 2. Electrical specifications and performance data contained herein are based on Mini-Circuit's applicable established test performance criteria and measurement instructions. 3. The parts covered by this specification sheet are subject to Mini-Circuits standard limited warranty and terms and conditions (collectively, "Standard Terms"); Purchasers of this part are entitled to the rights and benefits contained therein. For a full statement of the Standard Terms and the exclusive rights and remedies thereunder, please visit Mini-Circuits' website at [www.minicircuits.com/MCLStore/terms.jsp](http://www.minicircuits.com/MCLStore/terms.jsp).