

The Big Deal:

- Ultra Flat Gain Response:
± 0.2 dB over 1700-2300 MHz
- 50Ω Input and Output:
no External Components Required



CASE STYLE: DL1020

Product Overview:

YSF-232+ is an advanced amplifier module in a Mini-Circuits System In Package **MSiP™**. This module is fully matched to 50Ω in/out impedance and has built-in Input & Output DC block capacitors. It is enclosed in a 5 x 6 mm MCLP plastic package. The YSF-232+ uses E-PHEMT technology enabling it to work with a single positive supply voltage.

Key Features

Feature	Advantages
Superior Gain Flatness ± 0.2dB	The YSF-232+ provides industry leading gain flatness over the full PCS/UMTS communications band (1700-2300MHz) making this ideal for use in applications where gain-flatness and repeatability are critical performance requirements.
High Gain	The YSF-232+ is a two-stage design with internal feedback and bias to provide flat 20 dB nominal gain, supporting applications where a single gain block must overcome large system losses such as long cable runs and lossy components.
Strong Combination of Performance	The YSF-232+ provides a strong combination of performance parameters including high gain (20 dB), high IP3 (+35 dBm) and P1dB (+20 dBm) and low noise figures (2.9 dB) that are difficult to achieve in a single stage design and available only in the YSF amplifier series.
Integrated Matching, DC Blocking and Bias in Small Package	The YSF-232+ includes all support circuits including: Matching, Bias and DC Blocking, all integrated into a single 5x6mm package making the total footprint equal to or smaller than most solutions.
Excellent Return Loss	The YSF-232+ includes integrated input and output matching and bias circuits to make this amplifier a simple, complete drop-in solution. The matching circuits provide excellent output return loss (20dB), and are designed to give optimal P1dB and IP3 performance in a 50Ω environment.
High Reverse Isolation	With 30 dB of reverse isolation – the YSF-232+ is an ideal gain block for use in integrated systems to minimize VSWR interactions resulting from cascading highly reflective components such as sharp filters.

Flat Gain Amplifier

1.7-2.3 GHz

Product Features

- Matched 50-ohm surface mount amplifier
- High gain, 20 dB typ.
- Up to +20 dBm typ. output power
- High IP3, +35 dBm
- Low Noise Figure, 2.9 dB typ.
- High directivity, 30 dB isolation
- Internal Input & Output DC Block
- Separate terminal for DC



YSF-232+

CASE STYLE: DL1020
PRICE: \$2.69 ea. QTY. (20)

+ RoHS compliant in accordance with EU Directive (2002/95/EC)

The +Suffix has been added in order to identify RoHS Compliance. See our web site for RoHS Compliance methodologies and qualifications.

Typical Applications

- Cellular
- WCDMA
- Portable Wireless
- Receivers & transmitters
- PCS-Korea

General Description

YSF-232+ is an advanced amplifier module in a Mini-Circuits System In Package **MSiP™**. This module is fully matched to 50Ω in/out impedance and has built-in Input & Output DC block capacitors. It is enclosed in a 5 x 6 mm MCLP plastic package. The YSF-232+ uses E-PHEMT* technology enabling it to work with a single positive supply voltage.

simplified schematic and pad description

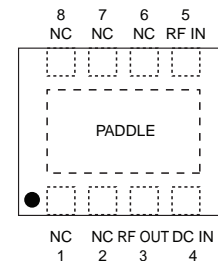
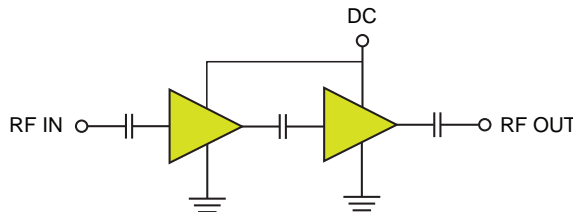

Function	Pad Number	Description
RF-IN	5	RF Input
RF-OUT	3	RF Output
DC	4	DC Supply
GND	Paddle	Connected to ground
NOT USED	1,2,6,7,8	No internal connection

*Enhancement mode Pseudomorphic High Electron Mobility Transistor

Electrical Specifications⁽¹⁾ at 25°C, Zo=50Ω unless noted

Parameter	Condition (MHz)	Min.	Typ.	Max.	Units
Frequency Range		1700		2300	MHz
Gain	1700	17.8	19.8	22.0	dB
	2000	18.0	20.0	22.0	
	2300	17.6	19.5	21.5	
Gain Flatness			± 0.2		dB
Input Return Loss	1700		10.0		dB
	2000	8.0	10.8		
	2300		12.6		
Output Return Loss	1700		23.5		dB
	2000	18.0	23.0		
	2300		19.0		
Reverse Isolation			30.0		dB
Output Power @ 1 dB compression	1700		20.0		dBm
	2000		20.0		
	2300	18.0	20.0		
Output Power @ 3 dB compression			21.0		dBm
Output IP3	1700		35.0		dBm
	2000	31.0	35.0		
	2300		35.0		
Noise Figure	1700		3.0		dB
	2000		2.8	3.8	
	2300		2.5		
Device Operating Voltage			5		V
Device Operating Current			118	145	mA
Device Current Variation vs. Temperature ⁽²⁾			2		μA/°C
Device Current Variation vs Voltage			0.002		mA/mV
Thermal Resistance, junction-to-ground lead ⁽³⁾			56		°C/W

⁽¹⁾ Measured on Mini-Circuits Characterization test board TB-589+. See Characterization Test Circuit (Fig. 1)

⁽²⁾ Δ(+85°C to -45°C)

⁽³⁾ Thermal Resistance= $\frac{\text{Hot spot temperature} - \text{Ground lead temperature}}{\text{Power Dissipation}}$

Absolute Maximum Ratings

Parameter	Ratings	Units
Operating Temperature ⁽⁴⁾	-40 to 85	°C
Storage Temperature	-65 to 150	°C
DC Voltage on Pad 4	7	V
Power Dissipation	1.5	W
Input Power	21	dBm

Note: Permanent damage may occur if any of these limits are exceeded.

These ratings are not intended for continuous normal operation.

⁽⁴⁾ Case is defined as ground paddle.

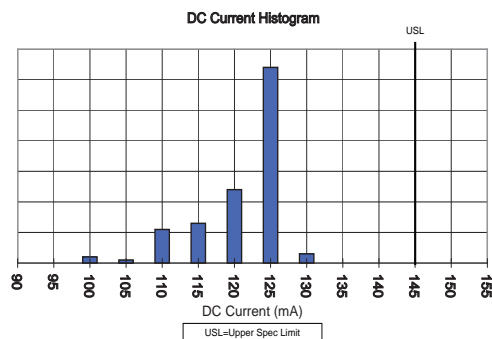

Characterization Test Circuit

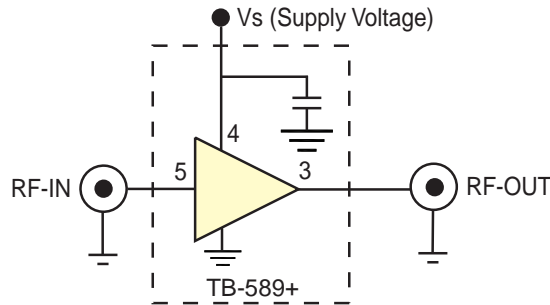

Fig 1. Block Diagram of Test Circuit used for characterization. (DUT soldered on Mini-Circuits Characterization Test Fixture TB-589+) Gain, Return loss, Output power at 1dB compression (P1 dB), Output IP3 (OIP3) and Noise Figure measured using Agilent's N5242A PNA-X microwave network analyzer.

Conditions:

1. Gain: Pin= -25dBm
2. Output IP3 (OIP3): Two tones, spaced 10 MHz apart, 2.5 dBm/tone at output.

Recommended Application Circuit

(refer to evaluation board for PCB Layout and component values)

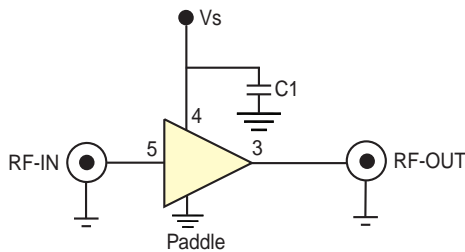
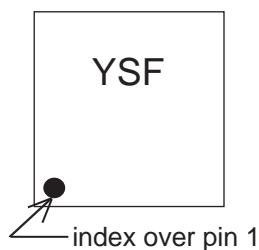









Fig 2. Recommended Application Circuit

Product Marking



Additional Detailed Technical Information

(additional information is available on our web site. To access this information enter the model number on our web site home page)

Performance Data	Data Table	
	Swept Graphs	
	S-Parameter (S2P Files) Data Set (.zip file)	
Case Style	DL1020 <i>Plastic package, exposed paddle, lead finish: tin/silver/nickel</i>	
Tape & Reel	F68	
Suggested Layout for PCB Design	PL-335	
Evaluation Board	TB-589-4+	
Environmental Ratings	ENV08T1	

ESD Rating

Human Body Model (HBM): Class 1A in accordance with ANSI/ESD STM 5.1 - 2001

Machine Model (MM): Class M3 (25V) in accordance with ANSI/ESD STM5.2-1999



Attention

Observe precautions for handling electrostatic sensitive devices

MSL Rating

Moisture Sensitivity: MSL1 in accordance with IPC/JEDEC J-STD-020D

MSL Test Flow Chart

