

The Big Deal:

- Ultra Flat Gain Response:
± 0.4 dB over 900-2150 MHz
- Excellent Combination of gain, P1dB, IP3 and NF
- 50Ω Input and Output:
no External Components Required



CASE STYLE: DL1020

Product Overview:

YSF-2151+ is an advanced amplifier module in a Mini-Circuits System In Package **MSiP™**. This module is fully matched to 50Ω in/out impedance and has built-in Input & Output DC block capacitors. It is enclosed in a 5 x 6 mm MCLP plastic package. The YSF-2151+ uses E-PHEMT technology enabling it to work with a single positive supply voltage.

Key Features

Feature	Advantages
Superior gain flatness ± 0.4dB	The YSF-2151+ provides industry leading gain flatness over the full satellite communications L Band (900-2150 MHz) making this ideal for use in applications where gain-flatness and repeatability are critical performance requirements.
High Gain	The YSF-2151+ is a two-stage design with internal feedback and bias to provide flat 20 dB nominal gain, supporting applications where a single gain block must overcome large system losses such as long cable runs and lossy components.
Strong Combination of Performance	The YSF-2151+ provides a strong combination of performance parameters including high gain (20 dB), high IP3 (+35 dBm) and P1dB (+20 dBm) and low noise figures (2.8 dB) that are difficult to achieve in a single stage design and available only in the YSF amplifier series.
Integrated Matching, DC Blocking and Bias in Small Package	The YSF-2151+ includes all support circuits including: Matching, Bias and DC Blocking, all integrated into a single 5x6mm package making the total footprint equal to or smaller than most solutions
Excellent Return Loss	The YSF-2151+ includes integrated input and output matching and bias circuits to make this amplifier a simple, complete drop-in solution. The matching circuits provide excellent output return loss (20dB), and are designed to give optimal P1dB and IP3 performance in a 50Ω environment.
High Reverse Isolation	With 30 dB of reverse isolation – the YSF-2151+ is an ideal gain block for use in integrated systems to minimize VSWR interactions resulting from cascading highly reflective components, such as sharp filters.

Flat Gain Amplifier

0.9-2.15 GHz

Product Features

- Matched 50-ohm surface mount amplifier
- High gain, 20 dB typ. at 2 GHz
- Up to +20 dBm typ. output power at 2 GHz
- High IP3, +35 dBm at 2 GHz
- Low Noise Figure, 2.8 dB typ. at 2 GHz
- High directivity, 30 dB isolation
- Internal Input & Output DC Block
- Separate terminal for DC



YSF-2151+

CASE STYLE: DL1020
PRICE: \$2.95 ea. QTY. (20)

+ RoHS compliant in accordance with EU Directive (2002/95/EC)

The +Suffix has been added in order to identify RoHS Compliance. See our web site for RoHS Compliance methodologies and qualifications.

Typical Applications

- Cellular
- Portable Wireless
- Satellite Communications
- Receivers & transmitters

General Description

YSF-2151+ is an advanced amplifier module in a Mini-Circuits System In Package **MSiP™**. This module is fully matched to 50Ω in/out impedance and has built-in Input & Output DC block capacitors. It is enclosed in a 5 x 6 mm MCLP plastic package. The YSF-2151+ uses E-PHEMT* technology enabling it to work with a single positive supply voltage.

simplified schematic and pad description

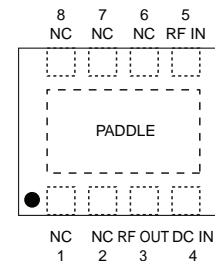
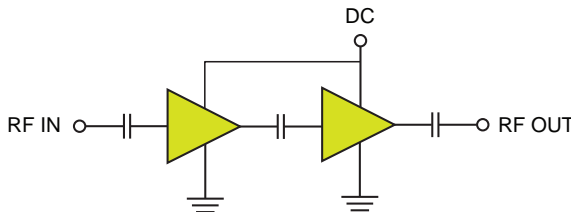

Function	Pad Number	Description
RF-IN	5	RF Input
RF-OUT	3	RF Output
DC	4	DC Supply
GND	Paddle	Connected to ground
NOT USED	1,2,6,7,8	No internal connection

*Enhancement mode Pseudomorphic High Electron Mobility Transistor

Electrical Specifications⁽¹⁾ at 25°C, Zo=50Ω unless noted

Parameter	Condition (MHz)	Min.	Typ.	Max.	Units
Frequency Range		900		2150	MHz
Gain	900	18.2	20.2	22.2	dB
	1600	18.0	20.0	22.0	
	2150	18.0	19.8	22.0	
Gain Flatness			0.4		± dB
Input Return Loss	900		10.0		dB
	1600	8.0	10.0		
	2150		11.5		
Output Return Loss	900		14.0		dB
	1600	16.0	22.0		
	2150		23.0		
Reverse Isolation			30.5		dB
Output Power @1 dB compression	900		20.0		dBm
	1600		20.0		
	2150	18.0	20.0		
Output Power @3 dB compression			21.0		dBm
Output IP3	900		36.0		dBm
	1600	30.0	35.0		
	2150		35.0		
Noise Figure	900		3.5		dB
	1600		3.1	4.1	
	2150		2.6		
Device Operating Voltage			5		V
Device Operating Current			118	145	mA
Device Current Variation vs. Temperature ⁽²⁾			2		μA/°C
Device Current Variation vs Voltage			0.002		mA/mV
Thermal Resistance, junction-to-ground lead ⁽³⁾			56		°C/W

⁽¹⁾ Measured on Mini-Circuits Characterization test board TB-589+. See Characterization Test Circuit (Fig. 1)

⁽²⁾ Δ(+85°C to -45°C)

⁽³⁾ Thermal Resistance= $\frac{\text{Hot spot temperature} - \text{Ground lead temperature}}{\text{Power Dissipation}}$

Absolute Maximum Ratings

Parameter	Ratings	Units
Operating Temperature ⁽⁴⁾	-40 to 85	°C
Storage Temperature	-65 to 150	°C
DC Voltage on Pad 4	7	V
Power Dissipation	1.5	W
Input Power	21	dBm

Note: Permanent damage may occur if any of these limits are exceeded. These ratings are not intended for continuous normal operation.

⁽⁴⁾ Case is defined as ground paddle.

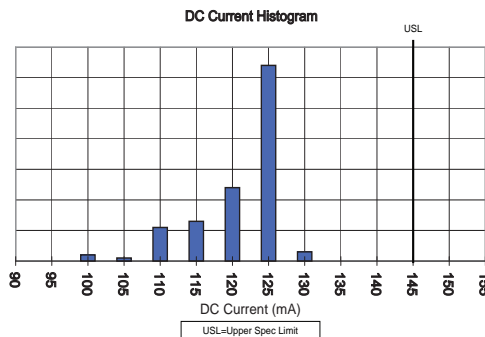

For detailed performance specs & shopping online see web site

P.O. Box 350166, Brooklyn, New York 11235-0003 (718) 934-4500 Fax (718) 332-4661 The Design Engineers Search Engine Provides ACTUAL Data Instantly at minicircuits.com

IF/RF MICROWAVE COMPONENTS

Notes: 1. Performance and quality attributes and conditions not expressly stated in this specification sheet are intended to be excluded and do not form a part of this specification sheet. 2. Electrical specifications and performance data contained herein are based on Mini-Circuit's applicable established test performance criteria and measurement instructions. 3. The parts covered by this specification sheet are subject to Mini-Circuits standard limited warranty and terms and conditions (collectively, "Standard Terms"); Purchasers of this part are entitled to the rights and benefits contained therein. For a full statement of the Standard Terms and the exclusive rights and remedies thereunder, please visit Mini-Circuits' website at www.minicircuits.com/MCLStore/terms.jsp.

Characterization Test Circuit

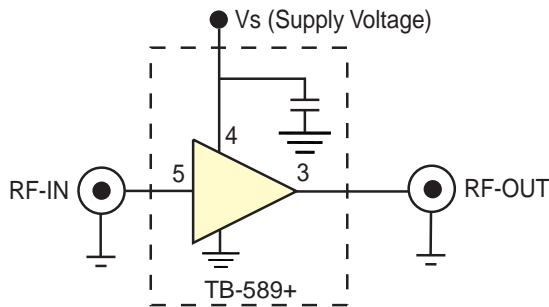

Fig 1. Block Diagram of Test Circuit used for characterization. (DUT soldered on Mini-Circuits Characterization Test Fixture TB-589+) Gain, Return loss, Output power at 1dB compression (P1 dB), Output IP3 (OIP3) and Noise Figure measured using Agilent’s N5242A PNA-X microwave network analyzer.

Conditions:

1. Gain: Pin= -25dBm
2. Output IP3 (OIP3): Two tones, spaced 1 MHz apart, 0 dBm/tone at output.

Recommended Application Circuit

(refer to evaluation board for PCB Layout and component values)

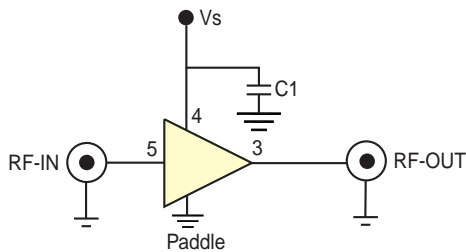
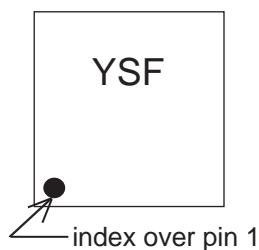









Fig 2. Recommended Application Circuit

Product Marking



Additional Detailed Technical Information <small>(additional information is available on our web site. To access this information enter the model number on our web site home page)</small>		
Performance Data	Data Table	
	Swept Graphs	
	S-Parameter (S2P Files) Data Set (.zip file)	
Case Style	DL1020 <i>Plastic package, exposed paddle, lead finish: tin/silver/nickel</i>	
Tape & Reel	F68	
Suggested Layout for PCB Design	PL-335	
Evaluation Board	TB-589-7+	
Environmental Ratings	ENV08T1	

ESD Rating

Human Body Model (HBM): Class 1A in accordance with ANSI/ESD STM 5.1 - 2001

Machine Model (MM): Class M1 (25V) in accordance with ANSI/ESD STM5.2-1999



Attention
 Observe precautions
 for handling electrostatic
 sensitive devices

MSL Rating

Moisture Sensitivity: MSL1 in accordance with IPC/JEDEC J-STD-020D

MSL Test Flow Chart

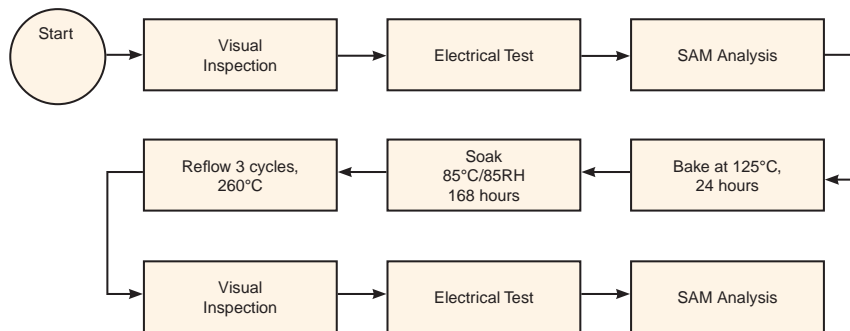

For detailed performance specs
 & shopping online see web site

P.O. Box 350166, Brooklyn, New York 11235-0003 (718) 934-4500 Fax (718) 332-4661 The Design Engineers Search Engine  Provides ACTUAL Data Instantly at minicircuits.com

Notes: 1. Performance and quality attributes and conditions not expressly stated in this specification sheet are intended to be excluded and do not form a part of this specification sheet. 2. Electrical specifications and performance data contained herein are based on Mini-Circuit's applicable established test performance criteria and measurement instructions. 3. The parts covered by this specification sheet are subject to Mini-Circuits standard limited warranty and terms and conditions (collectively, "Standard Terms"); Purchasers of this part are entitled to the rights and benefits contained therein. For a full statement of the Standard Terms and the exclusive rights and remedies thereunder, please visit Mini-Circuits' website at www.minicircuits.com/MCLStore/terms.jsp.