

Power Splitter/Combiner

TCP-2-182-75X+

2 Way-0° 75Ω 50 to 1800 MHz

The Big Deal

- Wideband, 50 to 1800 MHz
- Downstream optimized
- Good power handling, 0.5W as a splitter
- Low insertion loss, 0.8 dB
- Low unbalance, 0.25 dB
- High isolation, 26 dB
- Excellent VSWR, 1.20:1



CASE STYLE: DB1627

Product Overview

Mini-Circuits' TCP-2-182-75X+ is a 75Ω 2-way 0° surface-mount power splitter/combiner covering the 50 to 1800 MHz frequency range, supporting bandwidth requirements for DOCSIS® 3.1 systems and equipment, as well as other broadband applications. This model can handle up to 0.5W RF input power as a splitter, and provides low insertion loss and low phase and amplitude unbalance. It features core and wire construction mounted on a 6-lead plastic base (0.16 x 0.15 x 0.16") with Mini-Circuits' TopHat® feature to improve speed and accuracy of pick and place assembly. This design requires external capacitors and resistors for impedance matching and cycling isolation between the output signals (refer to electrical schematic).

Key Features

Feature	Advantages
Wideband, 50 to 1800 MHz	Optimized for low insertion loss at the high end of the downstream band, this device is suitable for many broadband applications including DOCSIS® 3.1 systems and equipment, VHF/UHF, CATV, cellular, and more.
Low insertion loss, 0.8 dB	The combination of 0.5W power handling and low insertion loss makes it a suitable candidate for distributing signals while maintaining signal power.
Good isolation, 26 dB	Minimizes interference between ports
Low unbalance: <ul style="list-style-type: none"> • 0.15 dB amplitude unbalance • 2.0° phase unbalance 	This model produces nearly equal output signals, making it ideal for use in parallel path /multichannel systems.
Top Hat® Feature	Improves speed and accuracy of pick and place assembly and provides clear device marking for visual inspection.

top hat[®]
Surface Mount
Power Splitter/Combiner

TCP-2-182-75X+

2 Way-0° 75Ω 50 to 1800 MHz

Features

- low insertion, 0.8 dB typ.
- optimized for the upper end of the downstream band
- excellent amplitude unbalance, 0.15 dB typ.
- very good phase unbalance, 2.0 deg. typ.
- external resistor & capacitor required
- aqueous washable
- low cost



CASE STYLE: DB1627

+RoHS Compliant

The +Suffix identifies RoHS Compliance. See our web site for RoHS Compliance methodologies and qualifications

Available Tape and Reel at no extra cost	
Reel Size	Devices/Reel
7"	20, 50, 100, 200, 500
13"	1000, 2000

Applications

- DOCSIS[®] 3.1 Systems
- VHF/UHF
- CATV

Electrical Specifications at 25°C

Parameter	Frequency (MHz)	Min.	Typ.	Max.	Unit
Frequency Range		10		1800	MHz
Insertion Loss Above 3.0 dB	10-1800	—	1.7	2.9	dB
	50-1000	—	0.5	0.9	
	1000-1250	—	0.7	1.2	
	1250-1500	—	0.9	1.5	
Isolation	10-1800	13	25	—	dB
	50-1000	20	26	—	
	1000-1250	20	30	—	
	1250-1500	17	26	—	
Phase Unbalance	10-1800	—	3.0	9.0	Degree
	50-1000	—	1.5	5.0	
	1000-1250	—	2.0	6.0	
	1250-1500	—	2.0	7.0	
Amplitude Unbalance	10-1800	—	0.5	1.2	dB
	50-1000	—	0.2	0.7	
	1000-1250	—	0.1	0.6	
	1250-1500	—	0.2	0.7	
VSWR (Port S)	10-1800	—	1.3	1.6	:1
	50-1000	—	1.15	1.3	
	1000-1250	—	1.15	1.3	
	1250-1500	—	1.25	1.35	
VSWR (Port 1-2)	10-1800	—	1.5	2.0	:1
	50-1000	—	1.20	1.4	
	1000-1250	—	1.2	1.3	
	1250-1500	—	1.25	1.40	

Maximum Ratings

Parameter	Ratings
Operating Temperature	-40°C to 85°C
Storage Temperature	-55°C to 100°C
Power Input (as a splitter)	0.5W max.

Permanent damage may occur if any of these limits are exceeded.

Electrical Schematic

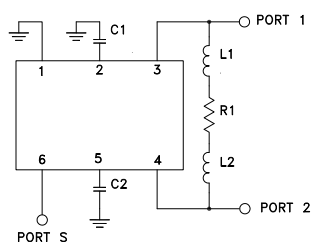

Pin Connections

Function	Pin Number
SUM PORT	6
PORT 1	3
PORT 2	4
GROUND	1
EXT. CAPACITOR 0.7 pF	2 to GND
EXT. CAPACITOR 0.7 pF	5 to GND
EXT. COMPONENTS (INDUCTOR 2.7 nH, RESISTOR 150Ω, INDUCTOR 2.7 nH IN SERIES)	3,4

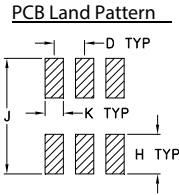
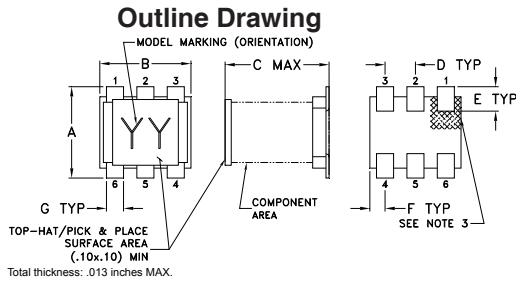

Suggested Layout,
Tolerance to be within .002

Outline Dimensions (inch/mm)

A	B	C	D	E	F
.160	.150	.160	.050	.040	.025
4.06	3.81	4.06	1.27	1.02	0.64
G	H	J	K	wt	
.028	.065	.190	.030	grams	
0.71	1.65	4.83	0.76	0.15	

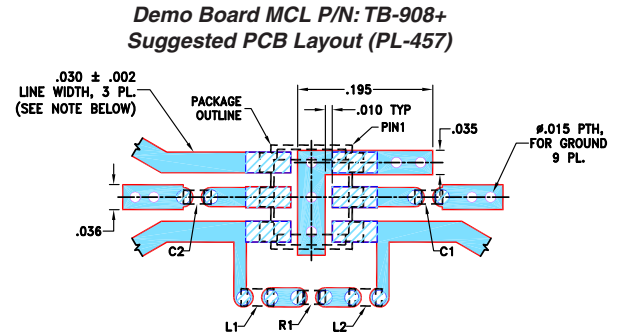

COMPONENT	SIZE
L1, L2	0402
C1, C2	0402
R1	0402

NOTES:

- TRACE WIDTH PARAMETERS ARE SHOWN FOR ROGERS R04350B WITH DIELECTRIC THICKNESS .030"±.002". COPPER: 1/2 OZ. EACH SIDE. FOR OTHER MATERIALS TRACE WIDTH AND GAP MAY NEED TO BE MODIFIED.
 - BOTTOM SIDE OF THE PCB IS CONTINUOUS GROUND PLANE.
- DENOTES PCB COPPER LAYOUT WITH SMOBC (SOLDER MASK OVER BARE COPPER).
 DENOTES COPPER LAND PATTERN FREE OF SOLDER MASK.

Typical Performance Data

Frequency (MHz)	Total Loss ¹ (dB)		Amplitude Unbalance (dB)	Isolation (dB)	Phase Unbalance (deg.)	VSWR S	VSWR 1	VSWR 2
	S-1	S-2						
10	3.76	3.18	0.58	18.46	2.56	1.11	1.58	1.35
30	3.55	3.17	0.39	22.11	1.53	1.05	1.34	1.21
50	3.49	3.16	0.32	23.61	1.12	1.03	1.27	1.17
100	3.44	3.18	0.26	25.12	0.60	1.01	1.21	1.14
200	3.43	3.21	0.22	25.97	0.01	1.03	1.17	1.12
300	3.44	3.24	0.20	26.42	0.39	1.06	1.15	1.12
400	3.45	3.27	0.18	26.93	0.67	1.09	1.13	1.12
600	3.48	3.33	0.15	28.85	1.16	1.15	1.11	1.14
800	3.52	3.41	0.11	32.26	1.60	1.19	1.10	1.17
1000	3.57	3.50	0.06	39.14	1.94	1.22	1.12	1.19
1250	3.67	3.65	0.02	37.94	2.29	1.20	1.17	1.21
1500	3.86	3.84	0.02	28.63	2.59	1.17	1.23	1.21
1600	3.98	3.93	0.05	26.18	2.77	1.15	1.26	1.21
1700	4.14	4.04	0.10	24.07	2.99	1.13	1.29	1.21
1800	4.35	4.18	0.17	22.08	3.38	1.12	1.32	1.21

1. Total Loss = Insertion Loss + 3dB splitter loss.

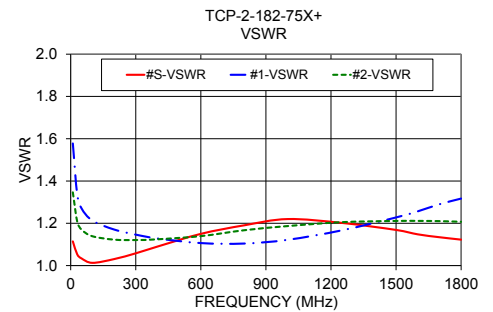
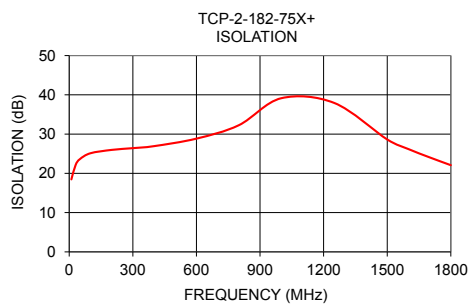
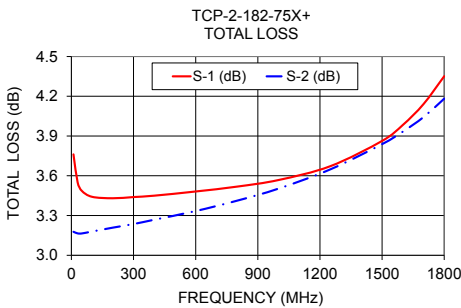

Additional Notes

- Performance and quality attributes and conditions not expressly stated in this specification document are intended to be excluded and do not form a part of this specification document.
- Electrical specifications and performance data contained in this specification document are based on Mini-Circuits' applicable established test performance criteria and measurement instructions.
- The parts covered by this specification document are subject to Mini-Circuits standard limited warranty and terms and conditions (collectively, "Standard Terms"); Purchasers of this part are entitled to the rights and benefits contained therein. For a full statement of the Standard Terms and the exclusive rights and remedies thereunder, please visit Mini-Circuits' website at www.minicircuits.com/MCLStore/terms.jsp