

Ultra Low Noise, High Current E-PHEMT

0.45-6GHz

Product Features

- Low Noise Figure, 0.5 dB
- Gain, 17 dB at 2 GHz
- High Output IP3, +33 dBm
- Output Power at 1dB comp., +19 dBm
- High Current, 60mA
- Wide bandwidth
- External biasing and matching required



TAV-541+

CASE STYLE: FG873
PRICE: \$1.39 ea. QTY. (10-49)

Typical Applications

- Cellular
- ISM
- GSM
- WCDMA
- WiMax
- WLAN
- UNII and HIPERLAN

+ RoHS compliant in accordance with EU Directive (2002/95/EC)

The +Suffix has been added in order to identify RoHS Compliance. See our web site for RoHS Compliance methodologies and qualifications.

General Description

TAV-541+ is an ultra-low noise, high IP3 transistor device, manufactured using E-PHEMT* technology enabling it to work with a single positive supply voltage. It has outstanding Noise Figure, particularly below 2.5 GHz, and when combining this noise figure with high IP3 performance in a single device it makes it an ideal amplifier for demanding base station applications. We offer these units assembled into a complete module, 50Ω in/out, noise matched and fully specified. For more information please see our TAMP family of models on our web site.

simplified schematic and pin description

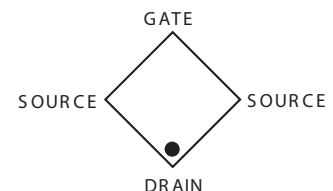
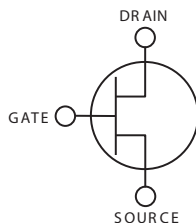

Function	Pad Number	Description
Source	2 & 4	Source terminal, normally connected to ground
Gate	3	Gate used for RF input
Drain	1	Drain used for RF output

* Enhancement mode Pseudomorphic High Electron Mobility Transistor.

Mini-Circuits
ISO 9001 ISO 14001 AS 9100 CERTIFIED

P.O. Box 350166, Brooklyn, New York 11235-0003 (718) 934-4500 Fax (718) 332-4661 The Design Engineers Search Engine Provides ACTUAL Data Instantly at minicircuits.com

IF/RF MICROWAVE COMPONENTS

For detailed performance specs & shopping online see web site

Notes: 1. Performance and quality attributes and conditions not expressly stated in this specification sheet are intended to be excluded and do not form a part of this specification sheet. 2. Electrical specifications and performance data contained herein are based on Mini-Circuit's applicable established test performance criteria and measurement instructions. 3. The parts covered by this specification sheet are subject to Mini-Circuits standard limited warranty and terms and conditions (collectively, "Standard Terms"); Purchasers of this part are entitled to the rights and benefits contained therein. For a full statement of the Standard Terms and the exclusive rights and remedies thereunder, please visit Mini-Circuits' website at www.minicircuits.com/MCLStore/terms.jsp.

REV. B
M123887
ED-13285
TAV-541+
090730
Page 1 of 13

Electrical Specifications at $T_{AMB}=25^{\circ}\text{C}$, Frequency 0.45 to 6 GHz

Symbol	Parameter	Condition	Min.	Typ.	Max.	Units
DC Specifications						
V_{GS}	Operational Gate Voltage	$V_{DS}=3\text{V}$, $I_{DS}=60\text{ mA}$	0.37	0.48	0.69	V
V_{TH}	Threshold Voltage	$V_{DS}=3\text{V}$, $I_{DS}=4\text{ mA}$	0.18	0.26	0.38	V
I_{DSS}	Saturated Drain Current	$V_{DS}=3\text{V}$, $V_{GS}=0\text{ V}$		1.0	5.0	μA
G_M	Transconductance	$V_{DS}=3\text{V}$, $G_m=\Delta I_{DS}/\Delta V_{GS}$ $\Delta V_{GS}=V_{GS1}-V_{GS2}$ $V_{GS1}=V_{GS}$ at $I_{DS}=60\text{ mA}$ $V_{GS2}=V_{GS1}+0.05\text{V}$	230	392	560	mS
I_{GSS}	Gate leakage Current	$V_{GD}=V_{GS}=-3\text{V}$			200	μA
RF Specifications, $Z_0=50\text{ Ohms}$ (Figure 1)						
NF ⁽¹⁾	Noise Figure	$V_{DS}=3\text{V}$, $I_{DS}=60\text{ mA}$ $V_{DS}=4\text{V}$, $I_{DS}=60\text{ mA}$	f=0.9 GHz f=2.0 GHz f=3.9 GHz f=5.8 GHz	0.4 0.5 1.0 1.8	0.9	dB
Gain	Gain	$V_{DS}=3\text{V}$, $I_{DS}=60\text{ mA}$ $V_{DS}=4\text{V}$, $I_{DS}=60\text{ mA}$	f=0.9 GHz f=2.0 GHz f=3.9 GHz f=5.8 GHz	15.5 23.8 17.9 12.7 9.5	18.9	dB
OIP3	Output IP3	$V_{DS}=3\text{V}$, $I_{DS}=60\text{ mA}$ $V_{DS}=4\text{V}$, $I_{DS}=60\text{ mA}$	f=0.9 GHz f=2.0 GHz f=3.9 GHz f=5.8 GHz	30.0 32.1 33.6 34.2 32.9		dBm
P1dB ⁽²⁾	Power output at 1 dB Compression	$V_{DS}=3\text{V}$, $I_{DS}=60\text{ mA}$ $V_{DS}=4\text{V}$, $I_{DS}=60\text{ mA}$	f=0.9 GHz f=2.0 GHz f=3.9 GHz f=5.8 GHz	18.9 19.1 19.4 19.6		dBm

Absolute Maximum Ratings⁽³⁾

Symbol	Parameter	Max.	Units
V_{DS} ⁽⁴⁾	Drain-Source Voltage	5	V
V_{GS} ⁽⁴⁾	Gate-Source Voltage	-5 to 0.7	V
V_{GD} ⁽⁴⁾	Gate-Drain Voltage	-5 to 0.7	V
I_{DS} ⁽⁴⁾	Drain Current	120	mA
I_{GS}	Gate Current	2	mA
P_{DISS}	Total Dissipated Power	550	mW
P_{IN} ⁽⁵⁾	RF Input Power	17	dBm
T_{CH}	Channel Temperature	150	$^{\circ}\text{C}$
T_{OP}	Operating Temperature	-40 to 85	$^{\circ}\text{C}$
T_{STD}	Storage Temperature	-65 to 150	$^{\circ}\text{C}$
Θ_{JC}	Thermal Resistance	112	$^{\circ}\text{C}/\text{W}$

Notes:

- (1) Includes test board loss (measured in test board TB-154).
- (2) Drain current bias allowed to increase during compression measurement.
- (3) Operation of this device above any one of these parameters may cause permanent damage.
- (4) Assumes DC quiescent conditions.
- (5) I_{GS} is limited to 2 mA during test.



ISO 9001 ISO 14001 AS 9100 CERTIFIED

P.O. Box 350166, Brooklyn, New York 11235-0003 (718) 934-4500 Fax (718) 332-4661 The Design Engineers Search Engine Provides ACTUAL Data Instantly at minicircuits.com

IF/RF MICROWAVE COMPONENTS

For detailed performance specs & shopping online see web site

Notes: 1. Performance and quality attributes and conditions not expressly stated in this specification sheet are intended to be excluded and do not form a part of this specification sheet. 2. Electrical specifications and performance data contained herein are based on Mini-Circuit's applicable established test performance criteria and measurement instructions. 3. The parts covered by this specification sheet are subject to Mini-Circuits standard limited warranty and terms and conditions (collectively, "Standard Terms"); Purchasers of this part are entitled to the rights and benefits contained therein. For a full statement of the Standard Terms and the exclusive rights and remedies thereunder, please visit Mini-Circuits' website at www.minicircuits.com/MCLStore/terms.jsp.

Characterization Test Circuit

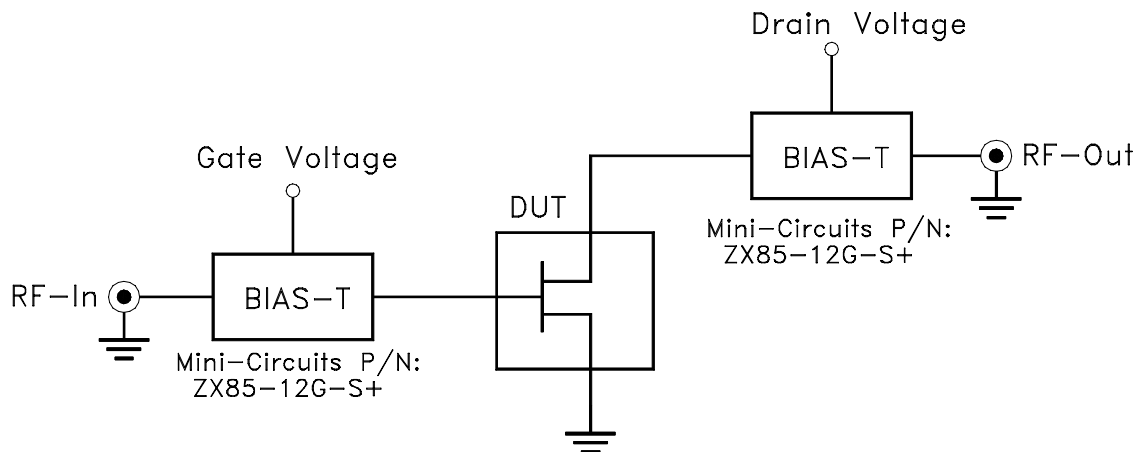

Fig 1. Block Diagram of Test Circuit used for characterization. (DUT soldered on Mini-Circuits Test Board TB-154)

Gain, Output power at 1dB compression (P_1 dB) and output IP3 (OIP3) are measured using R&S Network Analyzer ZVA-24. Noise Figure measured using Agilent Noise Figure meter N8975A and Noise Source N4000A.

Conditions:

1. Drain voltage (with reference to source, V_{DS}) = 3 or 4V as shown.
2. Gate Voltage (with reference to source, V_{GS}) is set to obtain desired Drain-Source current (I_{DS}) as shown in graphs or specification table.
3. Gain: $P_{in} = -25$ dBm
4. Output IP3 (OIP3): Two tones, spaced 1 MHz apart, 0 dBm/tone at output.
5. No external matching components used.

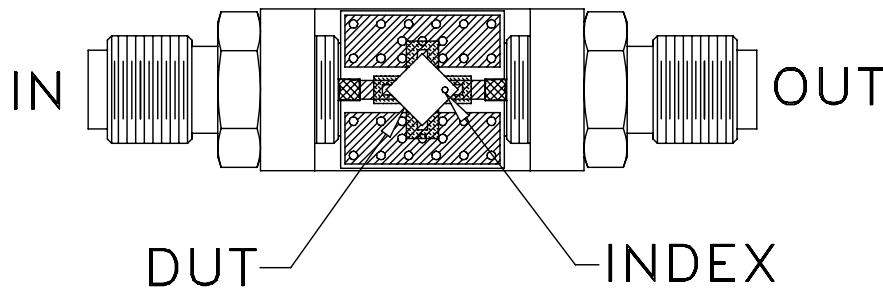

Fig 2. Test Board used for characterization, Mini-Circuits P/N TB-154 (Material: Rogers 4350, Thickness: 0.02")

Mini-Circuits
ISO 9001 ISO 14001 AS 9100 CERTIFIED

P.O. Box 350166, Brooklyn, New York 11235-0003 (718) 934-4500 Fax (718) 332-4661 The Design Engineers Search Engine  Provides ACTUAL Data Instantly at minicircuits.com

IFIRF MICROWAVE COMPONENTS

For detailed performance specs & shopping online see web site

Notes: 1. Performance and quality attributes and conditions not expressly stated in this specification sheet are intended to be excluded and do not form a part of this specification sheet. 2. Electrical specifications and performance data contained herein are based on Mini-Circuit's applicable established test performance criteria and measurement instructions. 3. The parts covered by this specification sheet are subject to Mini-Circuits standard limited warranty and terms and conditions (collectively, "Standard Terms"); Purchasers of this part are entitled to the rights and benefits contained therein. For a full statement of the Standard Terms and the exclusive rights and remedies thereunder, please visit Mini-Circuits' website at www.minicircuits.com/MCLStore/terms.jsp.

Typical Performance Curves

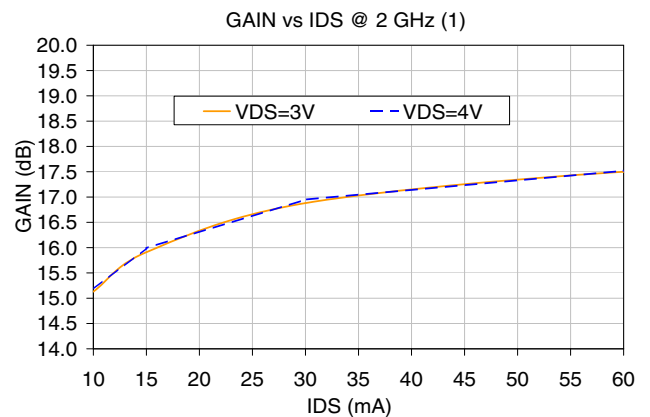
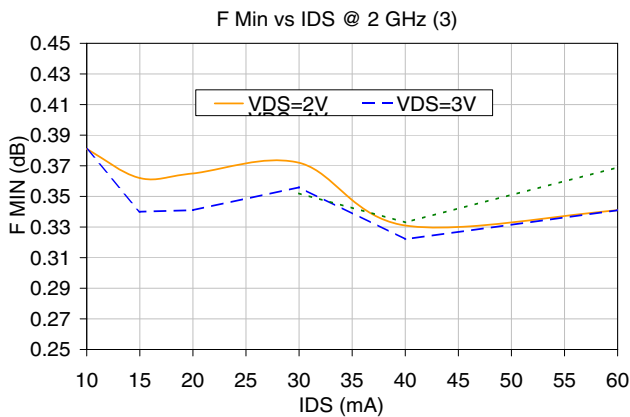
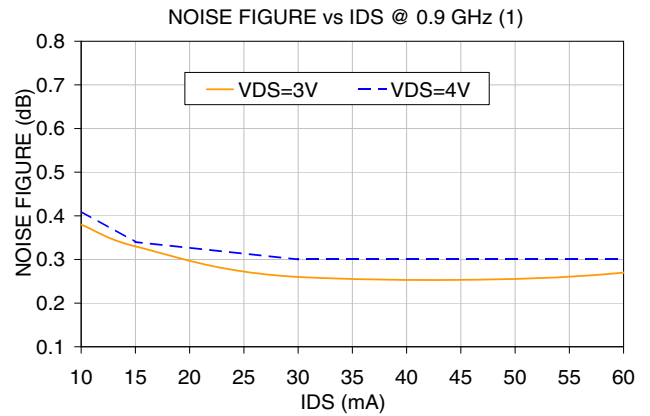
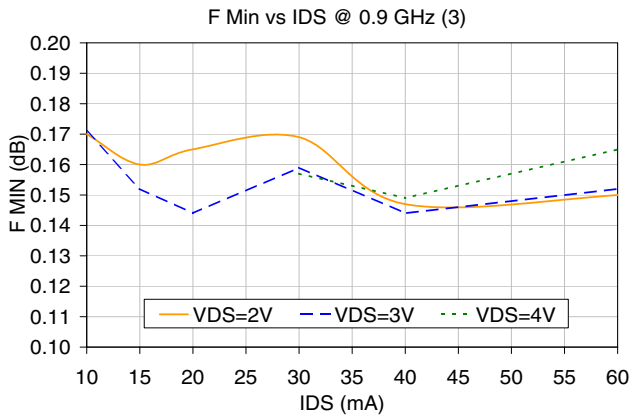
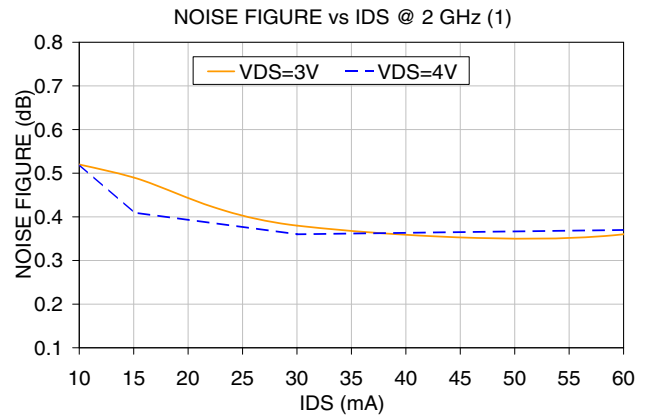
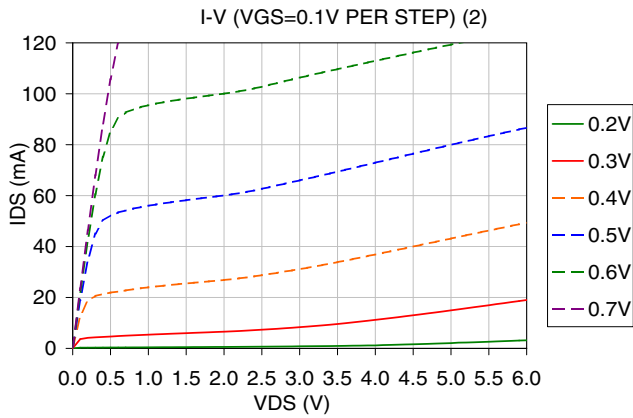

- (1) Includes test board loss, set-up and conditions per Figure 1.
- (2) Measured using HP4155B semiconductor parameter analyzer.
- (3) F Min is minimum Noise Figure
- (4) Draining current was allowed to increase during compression measurement.



For detailed performance specs & shopping online see web site

P.O. Box 350166, Brooklyn, New York 11235-0003 (718) 934-4500 Fax (718) 332-4661 The Design Engineers Search Engine Provides ACTUAL Data Instantly at minicircuits.com

IF/RF MICROWAVE COMPONENTS

Notes: 1. Performance and quality attributes and conditions not expressly stated in this specification sheet are intended to be excluded and do not form a part of this specification sheet. 2. Electrical specifications and performance data contained herein are based on Mini-Circuit's applicable established test performance criteria and measurement instructions. 3. The parts covered by this specification sheet are subject to Mini-Circuits standard limited warranty and terms and conditions (collectively, "Standard Terms"); Purchasers of this part are entitled to the rights and benefits contained therein. For a full statement of the Standard Terms and the exclusive rights and remedies thereunder, please visit Mini-Circuits' website at www.minicircuits.com/MCLStore/terms.jsp.

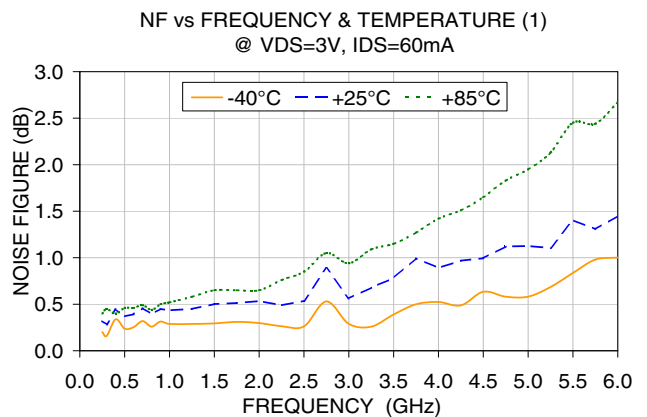
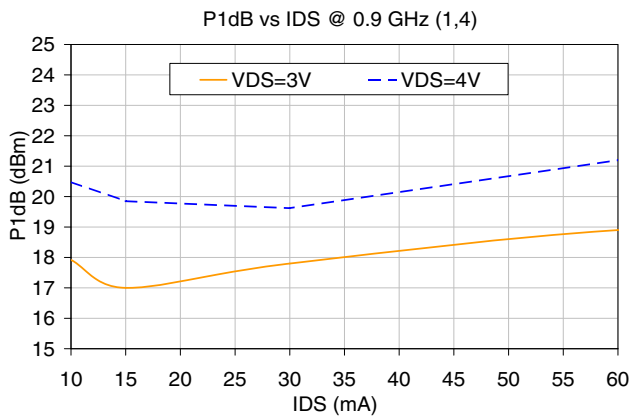
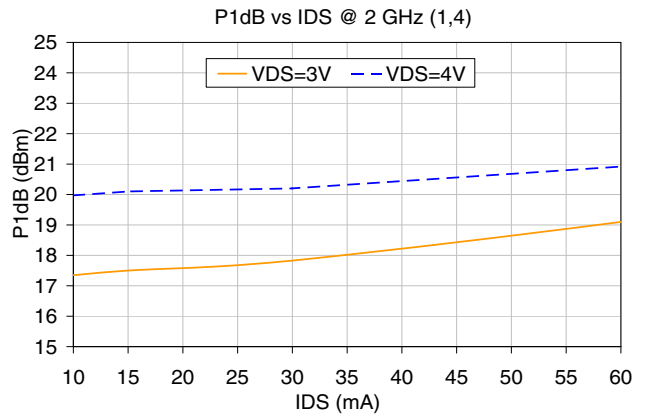
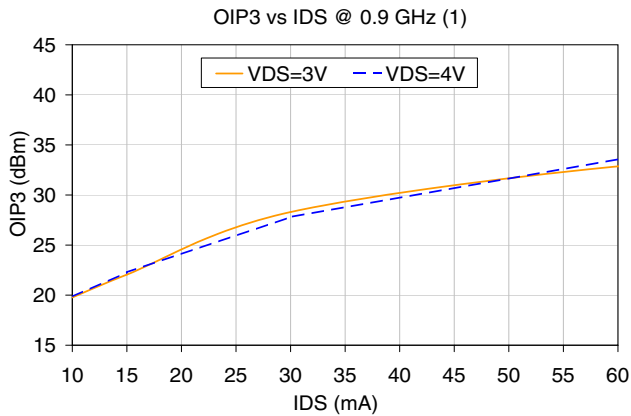
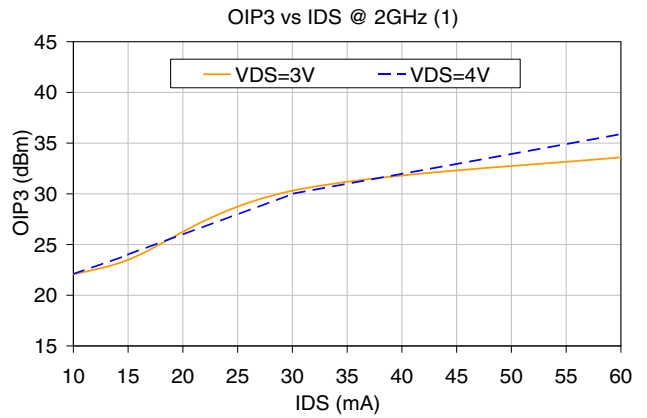
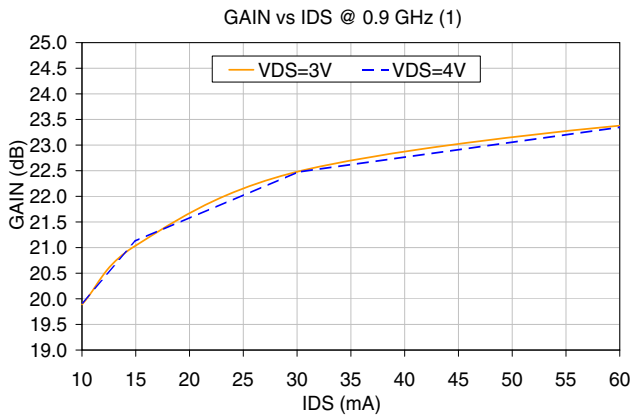

- (1) Includes test board loss, set-up and conditions per Figure 1.
- (2) Measured using HP4155B semiconductor parameter analyzer.
- (3) F Min is minimum Noise Figure
- (4) Draing current was allowed to increase during compression measurement.



For detailed performance specs & shopping online see web site

Notes: 1. Performance and quality attributes and conditions not expressly stated in this specification sheet are intended to be excluded and do not form a part of this specification sheet. 2. Electrical specifications and performance data contained herein are based on Mini-Circuit's applicable established test performance criteria and measurement instructions. 3. The parts covered by this specification sheet are subject to Mini-Circuits standard limited warranty and terms and conditions (collectively, "Standard Terms"); Purchasers of this part are entitled to the rights and benefits contained therein. For a full statement of the Standard Terms and the exclusive rights and remedies thereunder, please visit Mini-Circuits' website at www.minicircuits.com/MCLStore/terms.jsp.

GAIN vs FREQUENCY & TEMPERATURE (1)
@ VDS=3V, IDS=60mA

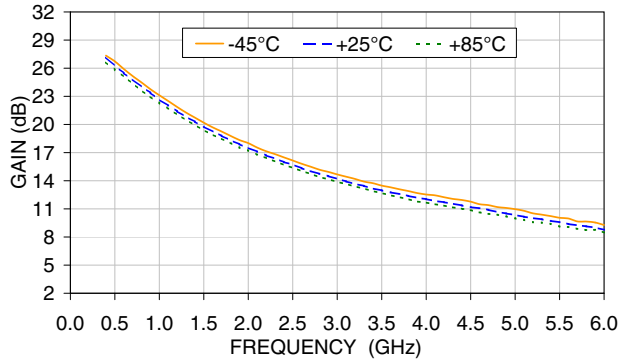

OIP3 vs FREQUENCY & TEMPERATURE (1)
@ VDS=3V, IDS=60mA

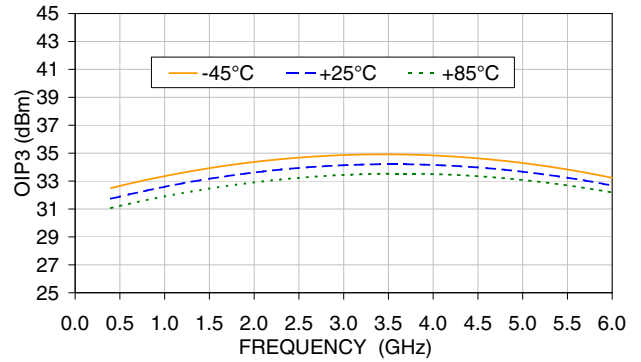

P1dB vs FREQUENCY & TEMPERATURE (1,4)
@ VDS=3V, IDS=60mA

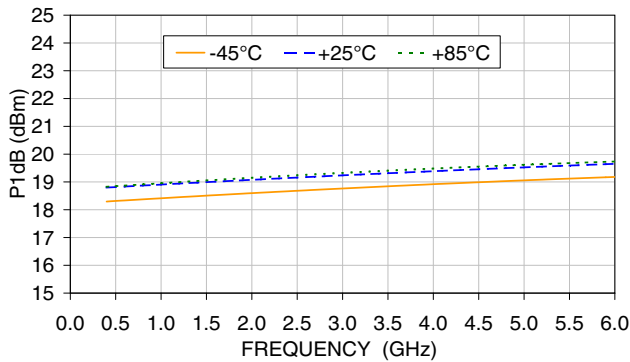

NF vs FREQUENCY & TEMPERATURE (1)
@ VDS=4V, IDS=60mA

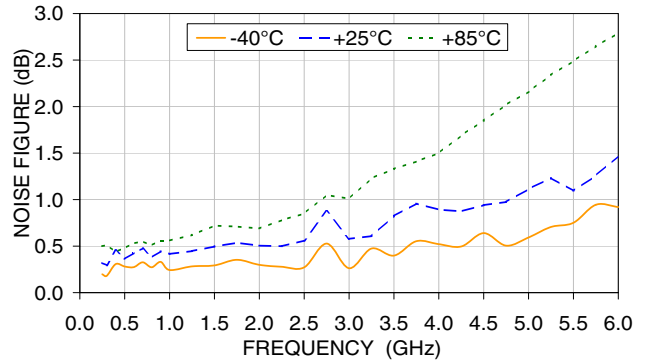

GAIN vs FREQUENCY & TEMPERATURE (1)
@ VDS=4V, IDS=60mA

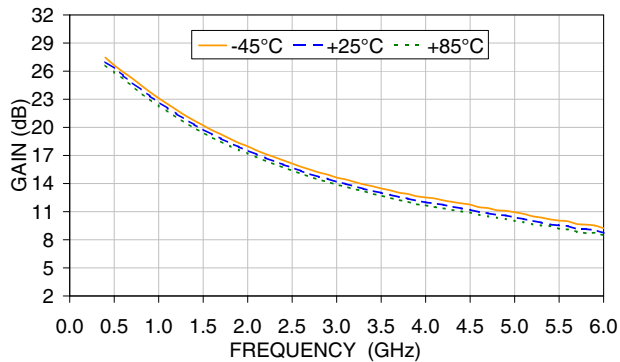

OIP3 vs FREQUENCY & TEMPERATURE (1)
@ VDS=4V, IDS=60mA

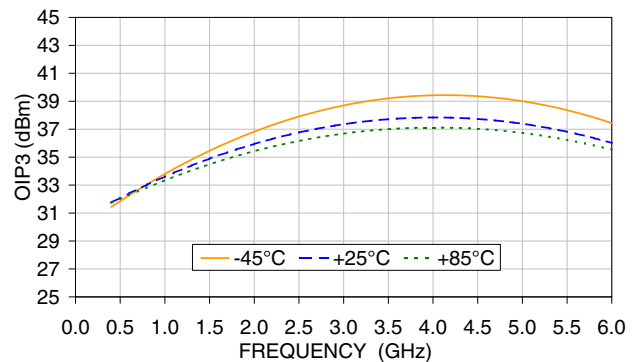

- (1) Includes test board loss, set-up and conditions per Figure 1.
- (2) Measured using HP4155B semiconductor parameter analyzer.
- (3) F Min is minimum Noise Figure
- (4) Draing current was allowed to increase during compression measurement.



For detailed performance specs & shopping online see web site

P.O. Box 350166, Brooklyn, New York 11235-0003 (718) 934-4500 Fax (718) 332-4661 The Design Engineers Search Engine Provides ACTUAL Data Instantly at minicircuits.com

Notes: 1. Performance and quality attributes and conditions not expressly stated in this specification sheet are intended to be excluded and do not form a part of this specification sheet. 2. Electrical specifications and performance data contained herein are based on Mini-Circuit's applicable established test performance criteria and measurement instructions. 3. The parts covered by this specification sheet are subject to Mini-Circuits standard limited warranty and terms and conditions (collectively, "Standard Terms"); Purchasers of this part are entitled to the rights and benefits contained therein. For a full statement of the Standard Terms and the exclusive rights and remedies thereunder, please visit Mini-Circuits' website at www.minicircuits.com/MCLStore/terms.jsp.

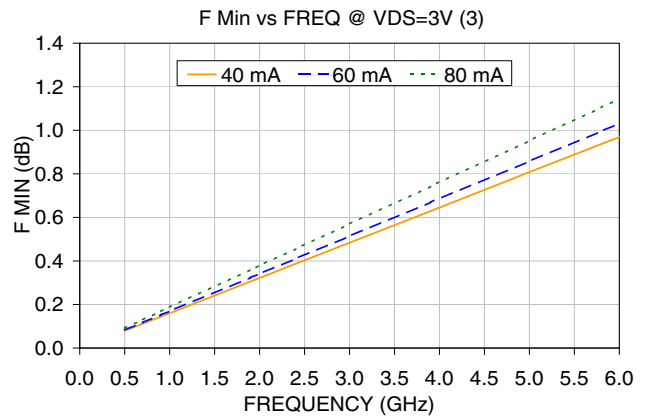
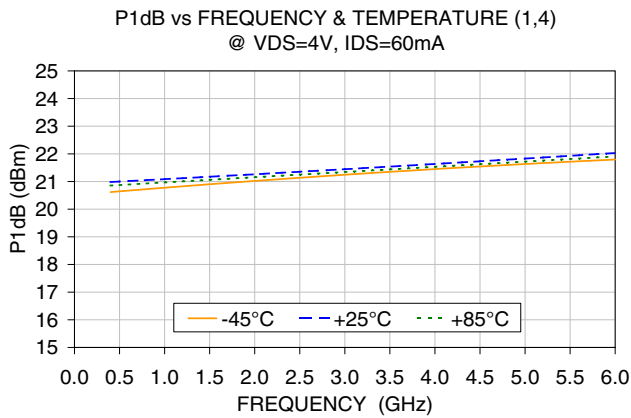

- (1) Includes test board loss, set-up and conditions per Figure 1.
- (2) Measured using HP4155B semiconductor parameter analyzer.
- (3) F Min is minimum Noise Figure
- (4) Draining current was allowed to increase during compression measurement.

Reference Plane Location for S and Noise Parameters *(see data in pages 8-11)*

(Refer to Application Note AN-60-040)

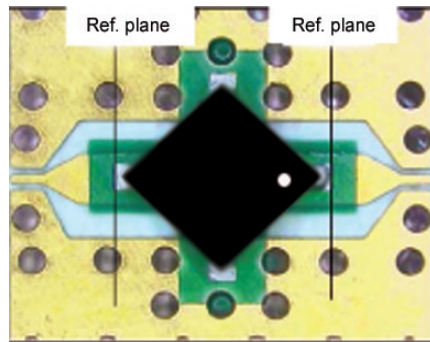

Fig 3. Reference Plane Location

Notes:

Noise parameters were measured over 0.5 to 6 GHz by Modelithics® using a solid state tuner-based NP noise parameter (NP) test system available from Maury Microwave. F Min, optimum source reflection coefficient and noise resistance values are calculated values based on a set of measurements made at approximately 16 different impedances. Some data smoothing was applied to arrive at the presented data set.

S-parameters were measured by Modelithics® on an Anritsu Lightning vector network analyzer over 0.1 to 18GHz using 350um pitch RF probes from GGB industries combined with customized thru-reflect-line (TRL) calibration standards. The reference plane is at the device package leads, as shown in the picture.

Typical S-parameters, $V_{DS}=3V$ and $I_{DS}=40\text{ mA}$ (Fig. 3)

Freq. (GHz)	S11		S21			S12		S22		MSG/MAG (dB)
	Mag.	Ang.	Mag.	Mag (dB)	Ang.	Mag.	Ang.	Mag.	Ang.	
0.1	0.99	-17.2	25.43	28.11	168.9	0.008	88.2	0.56	-14.38	35.0
0.5	0.87	-76.8	19.58	25.84	130.6	0.035	53.0	0.43	-57.19	27.5
0.9	0.76	-115.5	14.13	23.01	106.5	0.046	37.7	0.32	-86.00	24.8
1.0	0.74	-123.3	13.11	22.35	101.9	0.048	34.5	0.30	-92.51	24.4
1.5	0.69	-152.7	9.47	19.53	83.1	0.055	26.3	0.23	-117.37	22.3
1.9	0.67	-170.0	7.69	17.72	71.2	0.06	22.0	0.19	-134.11	21.1
2.0	0.67	-173.7	7.34	17.32	68.5	0.061	21.0	0.19	-138.02	20.8
2.5	0.66	169.4	6.00	15.56	55.6	0.068	16.3	0.16	-156.68	19.5
3.0	0.66	154.6	5.06	14.08	43.7	0.074	11.9	0.15	-174.75	18.4
4.0	0.66	129.3	3.84	11.68	21.3	0.087	2.3	0.14	-150.58	15.7
5.0	0.68	106.9	3.10	9.84	0.1	0.1	-8.8	0.15	-119.45	13.3
6.0	0.70	86.2	2.60	8.30	-20.5	0.115	-20.9	0.18	-92.56	11.8
7.0	0.72	66.4	2.22	6.94	-41.0	0.128	-34.2	0.22	-69.55	10.7
8.0	0.75	47.4	1.93	5.70	-61.0	0.139	-48.1	0.27	-49.63	9.8
9.0	0.79	28.5	1.68	4.48	-81.0	0.147	-63.3	0.34	-31.29	9.2
10.0	0.83	9.5	1.46	3.26	-101.2	0.152	-78.5	0.41	-13.77	8.9
11.0	0.86	-9.0	1.26	1.99	-121.1	0.153	-94.1	0.48	-2.86	9.2
12.0	0.89	-26.8	1.08	0.70	-140.7	0.151	-109.7	0.55	-18.99	8.6
13.0	0.91	-44.5	0.93	-0.61	-160.4	0.146	-125.6	0.60	-35.09	8.1
14.0	0.92	-61.1	0.80	-1.97	-179.5	0.139	-141.1	0.65	-50.57	7.6
15.0	0.94	-73.8	0.68	-3.33	-164.7	0.13	-153.6	0.70	-62.75	7.2
16.0	0.96	-83.9	0.58	-4.74	-151.0	0.119	-163.2	0.74	-73.16	6.9
17.0	0.96	-95.0	0.50	-6.11	-136.0	0.11	-174.5	0.77	-85.02	6.5
18.0	0.96	-107.0	0.42	-7.54	-120.2	0.101	-175.2	0.79	-98.18	6.2

MAXIMUM STABLE GAIN (MSG)/MAXIMUM AVAILABLE GAIN (MAG) vs. FREQUENCY

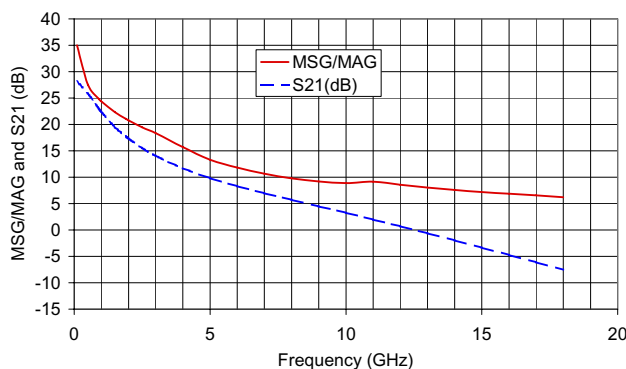

Typical Noise Parameters, $V_{DS}=3V$ and $I_{DS}=40\text{ mA}$ (Fig. 3)

Freq. (GHz)	F Min. (dB)	Γ_{Opt} (Magnitude)	Γ_{Opt} (Angle)	Rn/50	Ga
					Associated Gain (dB)
0.5	0.08	0.33	24.56	0.06	27.6
0.7	0.11	0.33	36.08	0.05	25.5
0.9	0.14	0.34	47.40	0.05	23.7
1.0	0.16	0.34	52.98	0.04	22.9
1.9	0.31	0.37	100.93	0.03	18.2
2.0	0.32	0.37	106.01	0.03	17.8
2.4	0.39	0.38	125.79	0.03	16.6
3.0	0.48	0.40	153.93	0.04	15.1
3.9	0.63	0.43	-167.30	0.06	13.5
5.0	0.81	0.46	-125.53	0.11	12.0
5.8	0.94	0.49	-99.03	0.16	11.1
6.0	0.97	0.50	-92.92	0.18	10.8

Notes:
 F Min.: Minimum Noise Figure
 Γ_{Opt} : Optimum Source Reflection Coefficient
 Rn: Equivalent noise resistance



For detailed performance specs & shopping online see web site

P.O. Box 350166, Brooklyn, New York 11235-0003 (718) 934-4500 Fax (718) 332-4661 The Design Engineers Search Engine Provides ACTUAL Data Instantly at minicircuits.com

IF/RF MICROWAVE COMPONENTS

Notes: 1. Performance and quality attributes and conditions not expressly stated in this specification sheet are intended to be excluded and do not form a part of this specification sheet. 2. Electrical specifications and performance data contained herein are based on Mini-Circuit's applicable established test performance criteria and measurement instructions. 3. The parts covered by this specification sheet are subject to Mini-Circuits standard limited warranty and terms and conditions (collectively, "Standard Terms"); Purchasers of this part are entitled to the rights and benefits contained therein. For a full statement of the Standard Terms and the exclusive rights and remedies thereunder, please visit Mini-Circuits' website at www.minicircuits.com/MCLStore/terms.jsp.

Typical S-parameters, $V_{DS}=3V$ and $I_{DS}=60\text{ mA}$ (Fig. 3)

Freq. (GHz)	S11		S21			S12		S22		MSG/MAG (dB)
	Mag.	Ang.	Mag.	Mag (dB)	Ang.	Mag.	Ang.	Mag.	Ang.	
0.1	1.00	-18.3	28.21	29.01	168.3	0.009	85.7	0.51	-16.71	34.9
0.5	0.85	-80.2	21.11	26.49	128.7	0.032	52.1	0.39	-62.25	28.1
0.9	0.74	-119.0	14.94	23.49	104.9	0.043	38.1	0.29	-93.22	25.5
1.0	0.73	-126.7	13.82	22.81	100.3	0.044	35.5	0.27	-100.07	24.9
1.5	0.68	-155.5	9.90	19.91	82.0	0.052	28.6	0.21	-126.53	22.8
1.9	0.66	-172.3	8.01	18.07	70.4	0.057	25.0	0.18	-144.11	21.5
2.0	0.66	-176.0	7.64	17.67	67.7	0.058	24.3	0.18	-148.27	21.2
2.5	0.65	167.5	6.23	15.89	55.1	0.065	19.8	0.16	-167.22	19.8
3.0	0.65	153.1	5.25	14.40	43.3	0.072	15.3	0.15	174.65	18.6
4.0	0.65	128.2	3.98	12.00	21.3	0.087	5.4	0.15	141.50	15.6
5.0	0.67	106.1	3.21	10.14	0.3	0.102	-6.5	0.17	112.56	13.5
6.0	0.69	85.6	2.69	8.59	-20.1	0.117	-19.1	0.20	87.55	12.0
7.0	0.72	66.0	2.30	7.23	-40.4	0.13	-33.1	0.24	65.85	10.8
8.0	0.75	47.1	1.99	5.98	-60.3	0.142	-47.3	0.29	46.59	9.9
9.0	0.78	28.3	1.73	4.76	-80.1	0.15	-62.8	0.35	28.80	9.3
10.0	0.82	9.4	1.50	3.54	-100.0	0.154	-78.4	0.42	11.67	9.0
11.0	0.86	-9.1	1.30	2.26	-119.7	0.155	-94.2	0.49	-4.75	9.2
12.0	0.89	-26.9	1.12	0.99	-139.3	0.152	-109.8	0.56	-20.66	8.7
13.0	0.91	-44.5	0.97	-0.30	-158.8	0.147	-125.7	0.61	-36.60	8.2
14.0	0.92	-61.1	0.83	-1.63	-177.8	0.139	-141.3	0.66	-52.00	7.7
15.0	0.94	-73.9	0.71	-2.97	166.5	0.132	-154.0	0.71	-64.02	7.3
16.0	0.96	-84.1	0.61	-4.32	152.8	0.12	-163.5	0.74	-74.32	7.1
17.0	0.96	-95.3	0.52	-5.67	138.0	0.11	-174.6	0.77	-85.98	6.8
18.0	0.96	-107.3	0.45	-7.02	122.0	0.102	174.4	0.79	-99.18	6.4

MAXIMUM STABLE GAIN (MSG)/MAXIMUM AVAILABLE GAIN (MAG) vs. FREQUENCY

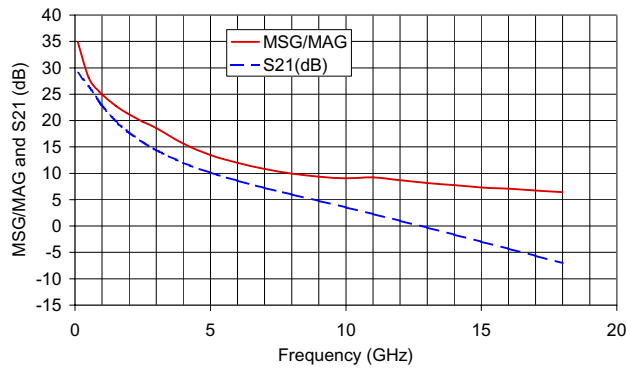

Typical Noise Parameters, $V_{DS}=3V$ and $I_{DS}=60\text{ ma}$ (Fig. 3)

Freq. (GHz)	F Min. (dB)	Γ Opt (Magnitude)	Γ Opt (Angle)	Rn/50	Ga
					Associated Gain (dB)
0.5	0.08	0.30	28.07	0.05	28.1
0.7	0.12	0.31	40.04	0.05	26.0
0.9	0.15	0.31	51.78	0.04	24.3
1.0	0.17	0.32	57.56	0.04	23.5
1.9	0.32	0.34	106.85	0.03	18.7
2.0	0.34	0.35	112.03	0.03	18.3
2.4	0.41	0.36	132.12	0.03	17.1
3.0	0.51	0.38	160.46	0.04	15.6
3.9	0.67	0.41	-161.11	0.06	13.9
5.0	0.86	0.46	-120.77	0.12	12.3
5.8	1.00	0.50	-96.02	0.18	11.3
6.0	1.03	0.50	-90.44	0.20	11.1

Notes:
 F Min.: Minimum Noise Figure
 Γ Opt: Optimum Source Reflection Coefficient
 Rn: Equivalent noise resistance



For detailed performance specs & shopping online see web site

P.O. Box 350166, Brooklyn, New York 11235-0003 (718) 934-4500 Fax (718) 332-4661 The Design Engineers Search Engine Provides ACTUAL Data Instantly at minicircuits.com

Notes: 1. Performance and quality attributes and conditions not expressly stated in this specification sheet are intended to be excluded and do not form a part of this specification sheet. 2. Electrical specifications and performance data contained herein are based on Mini-Circuit's applicable established test performance criteria and measurement instructions. 3. The parts covered by this specification sheet are subject to Mini-Circuits standard limited warranty and terms and conditions (collectively, "Standard Terms"); Purchasers of this part are entitled to the rights and benefits contained therein. For a full statement of the Standard Terms and the exclusive rights and remedies thereunder, please visit Mini-Circuits' website at www.minicircuits.com/MCLStore/terms.jsp.

Typical S-parameters, $V_{DS}=3V$ and $I_{DS}=80\text{ mA}$ (Fig. 3)

Freq. (GHz)	S11		S21			S12		S22		MSG/MAG (dB)
	Mag.	Ang.	Mag.	Mag (dB)	Ang.	Mag.	Ang.	Mag.	Ang.	
0.1	0.99	-19.1	29.68	29.45	168.0	0.008	79.9	0.48	-15.91	35.7
0.5	0.84	-81.5	21.98	26.84	127.8	0.03	52.2	0.37	-64.82	28.6
0.9	0.74	-120.4	15.43	23.77	104.1	0.041	39.3	0.27	-96.45	25.8
1.0	0.72	-128.1	14.26	23.08	99.6	0.042	36.9	0.26	-103.52	25.3
1.5	0.67	-156.6	10.17	20.15	81.6	0.05	30.5	0.20	-130.54	23.1
1.9	0.65	-173.2	8.22	18.30	70.0	0.055	26.8	0.18	-148.39	21.7
2.0	0.65	-176.8	7.85	17.89	67.4	0.057	26.1	0.17	-152.41	21.4
2.5	0.65	166.8	6.39	16.12	54.9	0.064	21.9	0.16	-171.38	20.0
3.0	0.65	152.5	5.38	14.62	43.3	0.071	17.3	0.15	170.84	18.8
4.0	0.65	127.8	4.08	12.21	21.4	0.087	7.1	0.15	138.34	15.7
5.0	0.66	105.9	3.29	10.35	0.5	0.102	-5.0	0.17	110.24	13.5
6.0	0.69	85.5	2.75	8.79	-19.8	0.117	-18.3	0.20	85.89	12.1
7.0	0.71	66.0	2.35	7.43	-40.0	0.131	-32.5	0.24	64.54	11.0
8.0	0.74	47.1	2.04	6.19	-59.8	0.142	-46.7	0.30	45.55	10.1
9.0	0.78	28.3	1.77	4.96	-79.5	0.151	-62.4	0.36	27.96	9.5
10.0	0.82	9.4	1.54	3.74	-99.4	0.155	-78.0	0.43	10.98	9.2
11.0	0.85	-9.0	1.33	2.47	-119.0	0.155	-93.9	0.50	-5.36	9.3
12.0	0.88	-26.8	1.15	1.21	-138.5	0.153	-109.6	0.56	-21.19	8.8
13.0	0.91	-44.5	0.99	-0.07	-158.0	0.148	-125.5	0.61	-37.07	8.3
14.0	0.92	-61.1	0.85	-1.39	-176.9	0.14	-141.0	0.66	-52.42	7.8
15.0	0.94	-73.9	0.73	-2.72	167.5	0.132	-154.1	0.71	-64.45	7.4
16.0	0.96	-84.2	0.63	-4.08	153.8	0.12	-163.4	0.74	-74.71	7.2
17.0	0.96	-95.4	0.54	-5.38	138.8	0.11	-174.4	0.77	-86.39	6.9
18.0	0.96	-107.3	0.46	-6.72	122.8	0.102	174.9	0.79	-99.50	6.6

MAXIMUM STABLE GAIN (MSG)/MAXIMUM AVAILABLE GAIN (MAG) vs. FREQUENCY

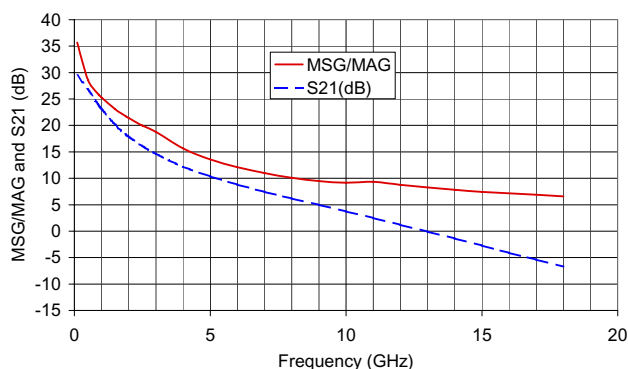

Typical Noise Parameters, $V_{DS}=3V$ and $I_{DS}=80\text{ mA}$ (Fig. 3)

Freq. (GHz)	F Min. (dB)	Γ_{Opt} (Magnitude)	Γ_{Opt} (Angle)	Rn/50	Ga
					Associated Gain (dB)
0.5	0.09	0.33	26.31	0.06	28.3
0.7	0.13	0.33	39.10	0.05	26.2
0.9	0.17	0.33	51.61	0.04	24.5
1.0	0.19	0.33	57.75	0.04	23.7
1.9	0.36	0.33	109.77	0.03	19.0
2.0	0.38	0.33	115.19	0.03	18.6
2.4	0.46	0.34	136.14	0.03	17.4
3.0	0.57	0.36	165.40	0.04	15.9
3.9	0.74	0.39	-155.61	0.07	14.1
5.0	0.95	0.45	-115.93	0.14	12.5
5.8	1.11	0.51	-92.56	0.21	11.5
6.0	1.14	0.52	-87.45	0.23	11.3

Notes:
 F Min.: Minimum Noise Figure
 Γ_{Opt} : Optimum Source Reflection Coefficient
 Rn: Equivalent noise resistance



For detailed performance specs & shopping online see web site

P.O. Box 350166, Brooklyn, New York 11235-0003 (718) 934-4500 Fax (718) 332-4661 The Design Engineers Search Engine Provides ACTUAL Data Instantly at minicircuits.com

IF/RF MICROWAVE COMPONENTS

Notes: 1. Performance and quality attributes and conditions not expressly stated in this specification sheet are intended to be excluded and do not form a part of this specification sheet. 2. Electrical specifications and performance data contained herein are based on Mini-Circuit's applicable established test performance criteria and measurement instructions. 3. The parts covered by this specification sheet are subject to Mini-Circuits standard limited warranty and terms and conditions (collectively, "Standard Terms"); Purchasers of this part are entitled to the rights and benefits contained therein. For a full statement of the Standard Terms and the exclusive rights and remedies thereunder, please visit Mini-Circuits' website at www.minicircuits.com/MCLStore/terms.jsp.

Typical S-parameters, $V_{DS}=4V$ and $I_{DS}=60\text{ mA}$ (Fig. 3)

Freq. (GHz)	S11		S21			S12		S22		MSG/MAG (dB)
	Mag.	Avg.	Mag.	Avg.	dB	Mag.	Ang.	Mag.	Ang.	
0.1	0.99	-18.6	28.21	29.01	168.0	0.008	81.4	0.53	-15.16	35.3
0.5	0.85	-80.1	21.15	26.51	128.6	0.032	50.7	0.41	-59.41	28.3
0.9	0.74	-118.9	14.97	23.51	104.8	0.042	38.3	0.29	-88.49	25.5
1.0	0.73	-126.7	13.85	22.83	100.2	0.044	36.0	0.27	-94.84	25.0
1.5	0.68	-155.5	9.92	19.93	81.9	0.051	28.6	0.21	-119.65	22.9
1.9	0.66	-172.3	8.03	18.10	70.3	0.056	24.9	0.18	-136.31	21.6
2.0	0.66	-176.0	7.67	17.69	67.6	0.057	24.2	0.17	-140.21	21.3
2.5	0.65	167.5	6.25	15.92	55.0	0.064	19.8	0.15	-158.90	19.9
3.0	0.65	153.1	5.26	14.42	43.3	0.071	15.5	0.14	-177.02	18.7
4.0	0.65	128.2	3.99	12.02	21.2	0.085	5.7	0.13	148.13	15.7
5.0	0.67	106.1	3.23	10.17	0.2	0.1	-5.8	0.14	117.31	13.5
6.0	0.69	85.6	2.70	8.63	-20.3	0.115	-18.2	0.17	90.98	12.1
7.0	0.72	66.0	2.31	7.28	-40.7	0.128	-32.0	0.21	68.42	11.0
8.0	0.75	47.1	2.01	6.05	-60.7	0.14	-46.1	0.27	48.79	10.1
9.0	0.78	28.3	1.74	4.83	-80.6	0.149	-61.5	0.33	30.75	9.6
10.0	0.82	9.4	1.52	3.62	-100.6	0.154	-76.9	0.40	13.54	9.4
11.0	0.86	-9.1	1.31	2.36	-120.5	0.155	-92.9	0.47	-3.07	9.3
12.0	0.89	-27.0	1.13	1.10	-140.2	0.153	-108.7	0.54	-19.05	8.7
13.0	0.91	-44.7	0.98	-0.20	-160.0	0.148	-124.7	0.60	-35.11	8.2
14.0	0.93	-61.4	0.84	-1.55	-179.2	0.141	-140.4	0.65	-50.62	7.7
15.0	0.94	-74.2	0.72	-2.90	165.0	0.132	-153.2	0.70	-62.85	7.3
16.0	0.96	-84.5	0.61	-4.30	151.1	0.12	-163.0	0.74	-73.26	7.1
17.0	0.96	-95.9	0.52	-5.64	135.9	0.111	-174.2	0.77	-85.15	6.7
18.0	0.96	-107.8	0.44	-7.06	119.8	0.103	174.4	0.79	-98.32	6.4

MAXIMUM STABLE GAIN (MSG)/MAXIMUM AVAILABLE GAIN (MAG) vs. FREQUENCY

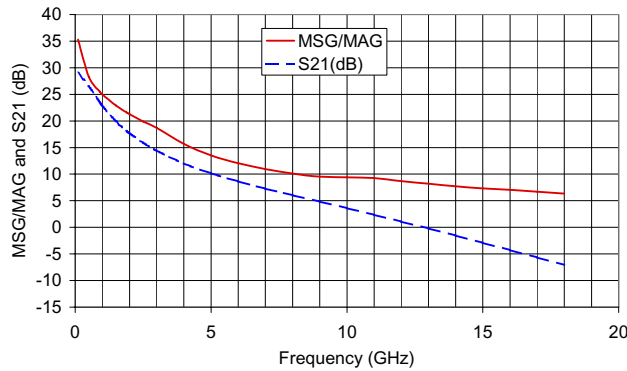

Typical Noise Parameters, $V_{DS}=4V$ and $I_{DS}=60\text{ mA}$ (Fig. 3)

Freq. (GHz)	F Min. (dB)	Γ_{Opt} (Magnitude)	Γ_{Opt} (Angle)	Rn/50	Ga
					Associated Gain (dB)
0.5	0.09	0.34	30.05	0.06	28.3
0.7	0.13	0.35	41.82	0.05	26.1
0.9	0.17	0.35	53.36	0.04	24.3
1.0	0.18	0.35	59.05	0.04	23.5
1.9	0.35	0.36	107.61	0.03	18.7
2.0	0.37	0.36	112.72	0.03	18.3
2.4	0.44	0.37	132.57	0.03	17.1
3.0	0.56	0.38	160.61	0.04	15.6
3.9	0.72	0.41	-161.21	0.06	13.9
5.0	0.93	0.45	-120.91	0.12	12.3
5.8	1.08	0.49	-95.98	0.18	11.3
6.0	1.11	0.50	-90.33	0.20	11.1

Notes:
 F Min.: Minimum Noise Figure
 Γ_{Opt} : Optimum Source Reflection Coefficient
 Rn: Equivalent noise resistance



For detailed performance specs & shopping online see web site

P.O. Box 350166, Brooklyn, New York 11235-0003 (718) 934-4500 Fax (718) 332-4661 The Design Engineers Search Engine Provides ACTUAL Data Instantly at minicircuits.com

Notes: 1. Performance and quality attributes and conditions not expressly stated in this specification sheet are intended to be excluded and do not form a part of this specification sheet. 2. Electrical specifications and performance data contained herein are based on Mini-Circuit's applicable established test performance criteria and measurement instructions. 3. The parts covered by this specification sheet are subject to Mini-Circuits standard limited warranty and terms and conditions (collectively, "Standard Terms"); Purchasers of this part are entitled to the rights and benefits contained therein. For a full statement of the Standard Terms and the exclusive rights and remedies thereunder, please visit Mini-Circuits' website at www.minicircuits.com/MCLStore/terms.jsp.

Product Marking

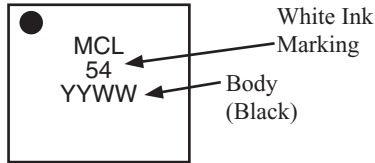

Additional Detailed Technical Information

Additional information is available on our web site www.minicircuits.com. To access this information enter the model number on our web site home page.

Performance data, graphs, s-parameter data set (.zip file)

Case Style: FG873

Plastic low profile 3mm x 3mm, lead finish: tin/silver/nickel

Suggested Layout for PCB Design: PL-301

Tape & Reel: F68

Characterization Test Board: TB-154+

Environmental Ratings: ENV08T2

ESD Rating

Human Body Model (HBM): Class 1A (250 V to < 500 V) in accordance with ANSI/ESD STM 5.1 - 2001

Machine Model (MM): Class M1 (40 V) in accordance with ANSI/ESD STM 5.2 - 1999

MSL Rating

Moisture Sensitivity: MSL1 in accordance with IPC/JEDECJ-STD-020D

MSL Test Flow Chart

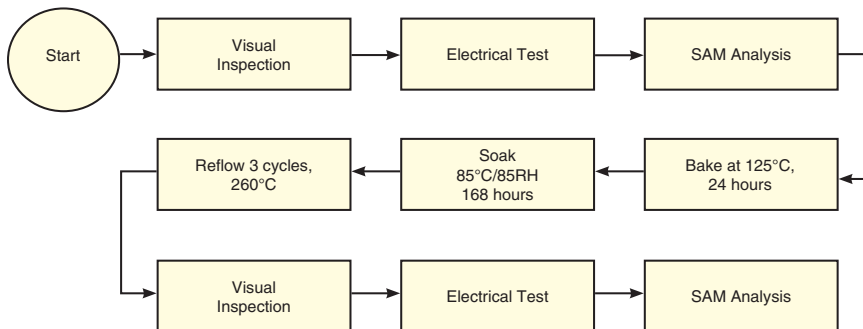

Recommended Application Circuit

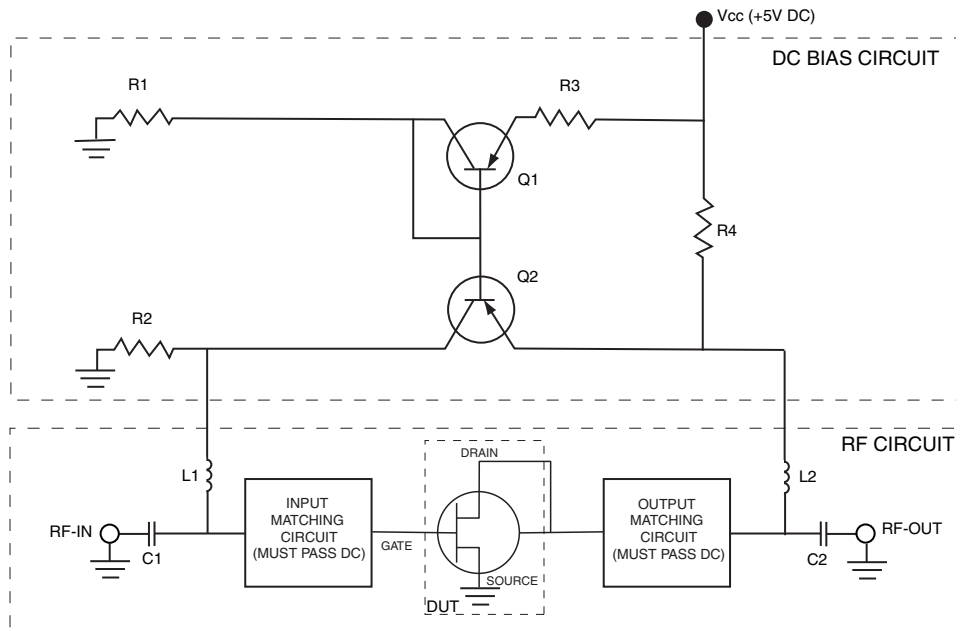

VDS, V (nom)	3	4
IDS, mA (nom)	60mA	60mA
R1	4320Ω	4320Ω
R2	4320Ω	4320Ω
R3	3570Ω	1210Ω
R4	33.2Ω	16.7Ω
Q1	MMBT3906*	MMBT3906*
Q2	MMBT3906*	MMBT3906*
C1	0.01μF	0.01μF
C2	0.01μF	0.01μF
L1**	840nH	840nH
L2**	840nH	840nH

* Fairchild Semiconductor™ part number
 ** Piconics™ part number CC45T47K240G5

Optimized Amplifier Circuits

For band specific, drop-in modules, and as an alternative to designing circuits, please refer to Mini-Circuits TAMP and RAMP series models which are based upon SAV/TAV E-PHEMT's and include all DC blocking, bias, matching and stabilization circuitry, without need for any external components.



For detailed performance specs & shopping online see web site

P.O. Box 350166, Brooklyn, New York 11235-0003 (718) 934-4500 Fax (718) 332-4661 *The Design Engineers Search Engine* Provides ACTUAL Data Instantly at minicircuits.com

Notes: 1. Performance and quality attributes and conditions not expressly stated in this specification sheet are intended to be excluded and do not form a part of this specification sheet. 2. Electrical specifications and performance data contained herein are based on Mini-Circuit's applicable established test performance criteria and measurement instructions. 3. The parts covered by this specification sheet are subject to Mini-Circuits standard limited warranty and terms and conditions (collectively, "Standard Terms"); Purchasers of this part are entitled to the rights and benefits contained therein. For a full statement of the Standard Terms and the exclusive rights and remedies thereunder, please visit Mini-Circuits' website at www.minicircuits.com/MCLStore/terms.jsp.