

Frequency Synthesizer

SSN-3600A-119+

50Ω 3400 to 3600 MHz

The Big Deal

- Low phase noise and spurious
- Very small size 0.60" x 0.60" x 0.138"

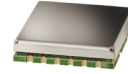

CASE STYLE: KJ1367

Product Overview

The SSN-3600A-119+ is a Frequency Synthesizer, designed to operate from 3400 to 3600 MHz for WiMAX application. The SSN-3600A-119+ is packaged in a metal case (size of 0.60" x 0.60" x 0.138") to shield against unwanted signals and noise.

Key Features

Feature	Advantages
Low phase noise and spurious: <ul style="list-style-type: none">• Phase Noise: -93 dBc/Hz typ. @ 10 kHz offset• Step Size Spurious: -83 dBc typ.• Comparison Spurious: -98 dBc typ.• Reference Spurious: -95 dBc typ.	Low phase noise and spurious improve system EVM (Error Vector Magnitude).
Robust design and construction	To enhance the robustness of SSN-3600A-119+, each internal component is secured to the substrate with chip bonder, thereby eliminating the risk of tombstoning during subsequent solder reflow operations by the customer.
Small size, 0.60" x 0.60" x 0.138"	The small size enables the SSN-3600A-119+ to be used in compact designs.



IF/RF MICROWAVE COMPONENTS • ISO 9001 ISO 14001 AS9100 CERTIFIED RoHS compliant

P.O. Box 350166, Brooklyn, New York 11235-0003 (718) 934-4500 Fax (718) 332-4661



The Design Engineers Search Engine finds the model you need, Instantly • For detailed performance specs & shopping online see



Notes: 1. Performance and quality attributes and conditions not expressly stated in this specification sheet are intended to be excluded and do not form a part of this specification sheet. 2. Electrical specifications and performance data contained herein are based on Mini-Circuit's applicable established test performance criteria and measurement instructions. 3. The parts covered by this specification sheet are subject to Mini-Circuits standard limited warranty and terms and conditions (collectively, "Standard Terms"); Purchasers of this part are entitled to the rights and benefits contained therein. For a full statement of the Standard Terms and the exclusive rights and remedies thereunder, please visit Mini-Circuits' website at www.minicircuits.com/MCLStore/terms.jsp.

50Ω 3400 to 3600 MHz

Features

- Fractional N synthesizer
- Integrated VCO + PLL
- Low phase noise and spurious
- Robust design and construction
- Low operating voltage (VCC VCO=+4.85V, VCC PLL=+3.2V)
- Small size 0.60" x 0.60" x 0.138"



CASE STYLE: KJ1367
 PRICE: \$29.95 ea. QTY (1-9)

+ RoHS compliant in accordance with EU Directive (2002/95/EC)

The +Suffix has been added in order to identify RoHS Compliance. See our web site for RoHS Compliance methodologies and qualifications.

Applications

- WiMAX

General Description

The SSN-3600A-119+ is a Frequency Synthesizer, designed to operate from 3400 to 3600 MHz for WiMAX application. The SSN-3600A-119+ is packaged in a metal case (size of 0.60" x 0.60" x 0.138") to shield against unwanted signals and noise. To enhance the robustness of SSN-3600A-119+, each internal component is secured to the substrate with chip bonder, thereby eliminating the risk of tombstoning during subsequent solder reflow operations by the customer.

Simplified Schematic

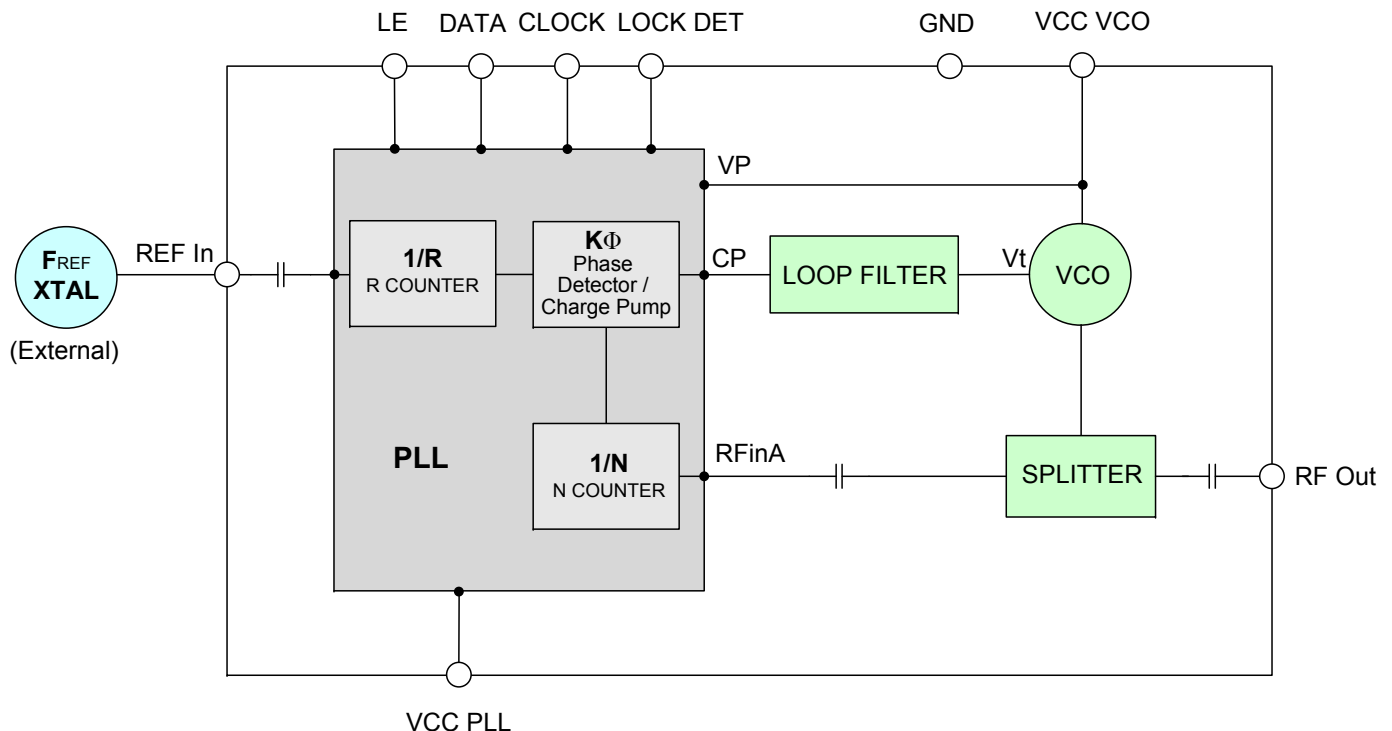

IF/RF MICROWAVE COMPONENTS • ISO 9001 ISO 14001 AS9100 CERTIFIED RoHS compliant
 P.O. Box 350166, Brooklyn, New York 11235-0003 (718) 934-4500 Fax (718) 332-4661



The Design Engineers Search Engine finds the model you need, Instantly • For detailed performance specs & shopping online see minicircuits.com

Notes: 1. Performance and quality attributes and conditions not expressly stated in this specification sheet are intended to be excluded and do not form a part of this specification sheet. 2. Electrical specifications and performance data contained herein are based on Mini-Circuit's applicable established test performance criteria and measurement instructions. 3. The parts covered by this specification sheet are subject to Mini-Circuits standard limited warranty and terms and conditions (collectively, "Standard Terms"); Purchasers of this part are entitled to the rights and benefits contained therein. For a full statement of the Standard Terms and the exclusive rights and remedies thereunder, please visit Mini-Circuits' website at www.minicircuits.com/MCLStore/terms.jsp.

Electrical Specifications (over operating temperature -40°C to +85°C)

Parameters	Test Conditions	Min.	Typ.	Max.	Units
Frequency Range	-	3400	-	3600	MHz
Step Size	-	-	125	-	kHz
Comparison Frequency	-	-	26	-	MHz
Settling Time	Within ± 1 kHz	-	30	50	mSec
Output Power	-	+1.0	+4.6	+7.0	dBm
SSB Phase Noise	@ 100 Hz offset	-	-78	-	dBc/Hz
	@ 1 kHz offset	-	-91	-84	
	@ 10 kHz offset	-	-93	-88	
	@ 100 kHz offset	-	-116	-112	
	@ 1 MHz offset	-	-137	-133	
Integrated SSB Phase Noise	@ 1kHz to 10MHz	-	-49	-45	dBc
Step Size Spurious Suppression	Step Size 125 kHz	-	-77	-62	dBc
0.5 Step Size Spurious Suppression	0.5 Step Size 62.5 kHz	-	-69	-54	
Reference Spurious Suppression	Ref. Freq. 52 MHz	-	-85	-77	
Comparison Spurious Suppression	Comp. Freq. 26 MHz	-	-85	-77	
Non - Harmonic Spurious Suppression	-	-	-90	-	
Harmonic Suppression	-	-	-32	-26	
VCO Supply Voltage	+4.85	+4.75	+4.85	+5.25	
PLL Supply Voltage	+3.20	+3.10	+3.20	+3.30	mA
VCO Supply Current	-	-	41	47	
PLL Supply Current	-	-	16	22	
Reference Input (External)	Frequency	52 (square wave)	-	52	
	Amplitude	1	-	1	V _{P-P}
	Input impedance	-	-	100	KΩ
	Phase Noise @ 1 kHz offset	-	-	-135	dBc/Hz
RF Output port Impedance	-	-	50	-	Ω
Input Logic Level	Input high voltage	-	2.65	-	V
	Input low voltage	-	-	0.60	V
Digital Lock Detect	Locked	-	2.70	-	3.30
	Unlocked	-	-	-	0.40
Frequency Synthesizer PLL	-	ADF4153			
PLL Programming	-	3-wire serial 3.2V CMOS			
Register Map @ 3600 MHz	R0_Register	-	(MSB) 1000101000000110000000 (LSB)		
	R1_Register	-	(MSB) 101001000001101000001 (LSB)		
	R2_Register	-	(MSB) 1111100010 (LSB)		
	R3_Register	-	(MSB) 1111000111 (LSB)		

Absolute Maximum Ratings

Parameters	Ratings
VCO Supply Voltage	5.8V
PLL Supply Voltage	4.0V
VCO Supply Voltage to PLL Supply Voltage	-0.3V to +5.8V
Reference Frequency Voltage	-0.3Vmin, VCC PLL +0.3Vmax
Data, Clock, LE Levels	-0.3Vmin, VCC PLL +0.3Vmax
Operating Temperature	-40°C to +85°C
Storage Temperature	-55°C to +100°C

Permanent damage may occur if any of these limits are exceeded



IF/RF MICROWAVE COMPONENTS • ISO 9001 ISO 14001 AS9100 CERTIFIED RoHS compliant
 P.O. Box 350166, Brooklyn, New York 11235-0003 (718) 934-4500 Fax (718) 332-4661 minicircuits.com
 The Design Engineers Search Engine finds the model you need, Instantly • For detailed performance specs & shopping online see

Notes: 1. Performance and quality attributes and conditions not expressly stated in this specification sheet are intended to be excluded and do not form a part of this specification sheet. 2. Electrical specifications and performance data contained herein are based on Mini-Circuit's applicable established test performance criteria and measurement instructions. 3. The parts covered by this specification sheet are subject to Mini-Circuits standard limited warranty and terms and conditions (collectively, "Standard Terms"); Purchasers of this part are entitled to the rights and benefits contained therein. For a full statement of the Standard Terms and the exclusive rights and remedies thereunder, please visit Mini-Circuits' website at www.minicircuits.com/MCLStore/terms.jsp.

Typical Performance Data

FREQUENCY (MHz)	POWER OUTPUT (dBm)			VCO CURRENT (mA)			PLL CURENT (mA)		
	-45°C	+25°C	+85°C	-45°C	+25°C	+85°C	-45°C	+25°C	+85°C
	3400	4.63	4.55	4.29	39.70	41.76	43.24	15.09	15.76
3404	4.62	4.53	4.27	39.69	41.77	43.24	14.84	15.53	17.73
3428	4.70	4.62	4.34	39.65	41.79	43.24	14.97	15.68	17.87
3452	4.66	4.55	4.28	39.67	41.77	43.24	15.10	15.82	18.01
3476	4.60	4.48	4.20	39.70	41.77	43.24	15.12	15.86	18.04
3500	4.57	4.46	4.16	39.67	41.78	43.31	15.18	15.93	18.11
3524	4.57	4.41	4.10	39.68	41.78	43.32	15.26	16.01	18.19
3548	4.64	4.48	4.16	39.68	41.76	43.21	15.27	16.04	18.21
3572	4.52	4.37	4.09	39.67	41.77	43.23	15.18	15.94	18.11
3596	4.50	4.33	4.02	39.68	41.76	43.22	15.10	15.85	18.02
3600	4.50	4.34	4.03	39.68	41.76	43.22	15.28	16.05	18.21

FREQUENCY (MHz)	HARMONICS (dBc)					
	F2			F3		
	-45°C	+25°C	+85°C	-45°C	+25°C	+85°C
3400	-37.87	-29.31	-31.25	-39.59	-37.05	-39.20
3404	-40.54	-30.46	-30.68	-40.32	-37.40	-40.71
3428	-39.97	-30.03	-33.24	-40.10	-35.88	-37.52
3452	-38.74	-31.85	-37.56	-37.65	-35.50	-36.88
3476	-38.54	-34.40	-37.09	-35.79	-33.40	-37.63
3500	-35.55	-35.09	-37.40	-34.68	-32.86	-37.51
3524	-33.94	-37.99	-38.85	-36.21	-33.76	-37.34
3548	-29.98	-46.13	-45.32	-35.77	-32.44	-37.59
3572	-29.77	-48.31	-47.28	-35.78	-32.54	-39.56
3596	-26.98	-47.78	-42.30	-38.67	-33.04	-39.29
3600	-27.32	-47.00	-43.49	-39.59	-33.13	-41.60



IF/RF MICROWAVE COMPONENTS • ISO 9001 ISO 14001 AS9100 CERTIFIED RoHS compliant
 P.O. Box 350166, Brooklyn, New York 11235-0003 (718) 934-4500 Fax (718) 332-4661



The Design Engineers Search Engine finds the model you need, Instantly • For detailed performance specs & shopping online see



Notes: 1. Performance and quality attributes and conditions not expressly stated in this specification sheet are intended to be excluded and do not form a part of this specification sheet. 2. Electrical specifications and performance data contained herein are based on Mini-Circuit's applicable established test performance criteria and measurement instructions. 3. The parts covered by this specification sheet are subject to Mini-Circuits standard limited warranty and terms and conditions (collectively, "Standard Terms"); Purchasers of this part are entitled to the rights and benefits contained therein. For a full statement of the Standard Terms and the exclusive rights and remedies thereunder, please visit Mini-Circuits' website at www.minicircuits.com/MCLStore/terms.jsp.

FREQUENCY (MHz)	PHASE NOISE (dBc/Hz) @ OFFSETS				
	+25°C				
	100Hz	1kHz	10kHz	100kHz	1MHz
3400	-82.26	-93.24	-93.91	-115.93	-136.89
3404	-80.31	-91.87	-94.65	-116.03	-136.93
3428	-80.46	-91.94	-94.25	-116.24	-137.08
3452	-80.83	-92.76	-93.63	-116.31	-137.05
3476	-81.05	-92.92	-94.17	-116.35	-137.13
3500	-81.09	-93.52	-93.59	-116.38	-137.19
3524	-80.32	-93.53	-93.73	-116.46	-137.15
3548	-81.43	-93.32	-93.50	-116.57	-137.31
3572	-81.67	-92.29	-93.31	-116.54	-137.25
3596	-78.86	-93.19	-92.96	-116.56	-137.20
3600	-80.37	-92.30	-93.06	-116.54	-137.19

FREQUENCY (MHz)	PHASE NOISE (dBc/Hz) @ OFFSETS				
	-45°C				
	100Hz	1kHz	10kHz	100kHz	1MHz
3400	-80.54	-92.01	-94.48	-115.92	-137.15
3404	-78.40	-90.77	-94.37	-115.88	-137.13
3428	-76.34	-91.04	-94.06	-116.25	-137.41
3452	-77.97	-91.54	-93.36	-116.28	-137.46
3476	-77.09	-90.52	-92.60	-116.39	-137.60
3500	-79.53	-90.65	-93.41	-116.60	-137.66
3524	-77.96	-91.45	-93.59	-116.70	-137.63
3548	-77.62	-90.64	-93.29	-116.81	-137.85
3572	-78.57	-89.13	-92.54	-116.72	-137.90
3596	-76.57	-90.96	-92.62	-116.78	-137.79
3600	-76.15	-90.17	-92.77	-116.73	-137.56

FREQUENCY (MHz)	PHASE NOISE (dBc/Hz) @ OFFSETS				
	+85°C				
	100Hz	1kHz	10kHz	100kHz	1MHz
3400	-79.69	-94.18	-94.62	-115.68	-136.51
3404	-76.75	-93.81	-94.36	-115.67	-136.46
3428	-80.89	-93.73	-94.09	-115.70	-136.61
3452	-80.59	-93.18	-94.21	-115.67	-136.54
3476	-79.51	-93.32	-93.52	-115.70	-136.61
3500	-78.78	-92.32	-93.49	-115.89	-136.59
3524	-78.37	-92.23	-93.35	-115.74	-136.45
3548	-79.21	-92.93	-93.59	-116.09	-136.86
3572	-79.50	-92.84	-93.31	-115.98	-136.76
3596	-80.07	-92.07	-92.80	-116.18	-136.71
3600	-79.61	-93.17	-92.73	-116.11	-136.69



IF/RF MICROWAVE COMPONENTS • ISO 9001 ISO 14001 AS9100 CERTIFIED RoHS compliant
 P.O. Box 350166, Brooklyn, New York 11235-0003 (718) 934-4500 Fax (718) 332-4661



The Design Engineers Search Engine finds the model you need, Instantly • For detailed performance specs & shopping online see



Notes: 1. Performance and quality attributes and conditions not expressly stated in this specification sheet are intended to be excluded and do not form a part of this specification sheet. 2. Electrical specifications and performance data contained herein are based on Mini-Circuit's applicable established test performance criteria and measurement instructions. 3. The parts covered by this specification sheet are subject to Mini-Circuits standard limited warranty and terms and conditions (collectively, "Standard Terms"); Purchasers of this part are entitled to the rights and benefits contained therein. For a full statement of the Standard Terms and the exclusive rights and remedies thereunder, please visit Mini-Circuits' website at www.minicircuits.com/MCLStore/terms.jsp.

COMPARISON SPURIOUS ORDER	COMPARISON SPURIOUS @Fcarrier 3400MHz+(n*Fcomparison) (dBc) note 1			COMPARISON SPURIOUS @Fcarrier 350MHz+(n*Fcomparison) (dBc) note 1			COMPARISON SPURIOUS @Fcarrier 3600MHz+(n*Fcomparison) (dBc) note 1		
	n	-45°C	+25°C	+85°C	-45°C	+25°C	+85°C	-45°C	+25°C
-5	-106.01	-107.05	-108.60	-108.93	-105.63	-112.68	-112.21	-103.99	-109.13
-4	-94.66	-95.09	-93.24	-96.76	-96.78	-95.26	-98.27	-96.84	-97.31
-3	-103.97	-102.12	-107.41	-105.35	-105.02	-105.49	-107.54	-110.41	-108.17
-2	-85.64	-84.90	-83.54	-88.32	-86.38	-85.66	-88.42	-87.14	-88.33
-1	-102.85	-97.64	-103.37	-100.26	-98.70	-100.50	-103.10	-104.15	-102.83
0 note 2	-	-	-	-	-	-	-	-	-
+1	-101.69	-95.77	-98.54	-99.05	-96.10	-98.36	-97.94	-97.62	-99.92
+2	-87.02	-87.23	-85.10	-89.57	-88.89	-85.12	-92.57	-89.63	-89.87
+3	-107.28	-107.67	-107.69	-104.33	-107.36	-104.84	-109.08	-118.36	-108.02
+4	-94.89	-94.68	-94.24	-95.72	-94.63	-93.51	-95.56	-94.08	-93.79
+5	-110.15	-112.69	-105.36	-115.76	-104.54	-107.57	-107.80	-104.51	-103.31

Note 1: Comparison frequency 26 MHz
 Note 2: All spurs are referenced to carrier signal (n=0).

REFERENCE SPURIOUS ORDER	REFERENCE SPURIOUS @Fcarrier 3400MHz+(n*Freference) (dBc) note 3			REFERENCE SPURIOUS @Fcarrier 3500MHz+(n*Freference) (dBc) note 3			REFERENCE SPURIOUS @Fcarrier 3600MHz+(n*Freference) (dBc) note 3		
	n	-45°C	+25°C	+85°C	-45°C	+25°C	+85°C	-45°C	+25°C
-5	-85.46	-88.22	-90.30	-89.16	-91.87	-95.63	-91.29	-94.61	-97.51
-4	-91.26	-90.78	-90.58	-93.94	-93.27	-92.65	-95.46	-96.18	-94.77
-3	-100.31	-100.10	-96.51	-101.62	-106.05	-97.93	-102.93	-107.82	-100.60
-2	-94.64	-95.09	-92.95	-96.70	-96.69	-95.12	-98.17	-96.77	-97.14
-1	-85.43	-84.91	-83.66	-88.26	-86.30	-85.78	-88.40	-87.11	-88.44
0 note 4	-	-	-	-	-	-	-	-	-
+1	-87.08	-87.36	-85.16	-89.61	-88.90	-85.19	-92.59	-89.59	-90.08
+2	-94.57	-94.53	-94.49	-95.71	-94.76	-93.64	-95.48	-94.15	-94.11
+3	-104.96	-103.68	-102.49	-105.50	-109.92	-102.74	-104.69	-111.13	-103.89
+4	-92.27	-92.83	-93.79	-95.14	-97.06	-95.82	-96.63	-98.12	-98.74
+5	-87.88	-91.24	-93.90	-91.90	-95.04	-97.63	-93.36	-95.79	-98.97

Note 3: Reference frequency 52 MHz
 Note 4: All spurs are referenced to carrier signal (n=0).



IF/RF MICROWAVE COMPONENTS • ISO 9001 ISO 14001 AS9100 CERTIFIED RoHS compliant
 P.O. Box 350166, Brooklyn, New York 11235-0003 (718) 934-4500 Fax (718) 332-4661



The Design Engineers Search Engine finds the model you need, Instantly • For detailed performance specs & shopping online see minicircuits.com

Notes: 1. Performance and quality attributes and conditions not expressly stated in this specification sheet are intended to be excluded and do not form a part of this specification sheet. 2. Electrical specifications and performance data contained herein are based on Mini-Circuit's applicable established test performance criteria and measurement instructions. 3. The parts covered by this specification sheet are subject to Mini-Circuits standard limited warranty and terms and conditions (collectively, "Standard Terms"); Purchasers of this part are entitled to the rights and benefits contained therein. For a full statement of the Standard Terms and the exclusive rights and remedies thereunder, please visit Mini-Circuits' website at www.minicircuits.com/MCLStore/terms.jsp.

STEP SIZE SPURIOUS ORDER n	0.5 STEP SIZE & STEP SIZE SPURIOUS @Fcarrier 3400MHz+(n*Fstep size) (dBc) note 5			0.5 STEP SIZE & STEP SIZE SPURIOUS @Fcarrier 3500MHz+(n*Fstep size) (dBc) note 5			0.5 STEP SIZE & STEP SIZE SPURIOUS @Fcarrier 3600MHz+(n*Fstep size) (dBc) note 5		
	-45°C	+25°C	+85°C	-45°C	+25°C	+85°C	-45°C	+25°C	+85°C
-5.0	-109.06	-107.76	-111.71	-113.06	-111.89	-112.16	-112.21	-111.14	-108.24
-4.5	-111.94	-107.81	-109.94	-108.57	-111.02	-106.18	-107.98	-110.64	-100.31
-4.0	-109.47	-106.29	-106.94	-107.64	-106.39	-107.02	-107.54	-107.99	-104.60
-3.5	-106.84	-104.88	-105.17	-106.99	-105.76	-107.78	-107.63	-105.89	-105.29
-3.0	-102.79	-106.56	-104.86	-107.89	-106.33	-104.96	-106.15	-102.79	-105.81
-2.5	-97.58	-100.97	-102.63	-101.58	-102.89	-102.86	-101.46	-103.44	-100.60
-2.0	-87.50	-88.36	-93.26	-95.60	-95.89	-99.11	-100.63	-100.10	-99.03
-1.5	-88.80	-94.46	-92.97	-92.59	-91.71	-95.57	-91.66	-90.64	-94.93
-1.0	-82.52	-79.33	-78.53	-84.73	-85.02	-86.24	-87.68	-88.25	-86.67
-0.5	-64.84	-70.04	-78.46	-73.06	-75.99	-80.47	-74.83	-79.73	-84.52
0 note 6	-	-	-	-	-	-	-	-	-
+0.5	-66.26	-69.51	-78.46	-71.67	-75.06	-80.21	-72.88	-87.01	-82.73
+1.0	-83.37	-78.66	-77.99	-86.60	-82.35	-85.98	-87.59	-88.00	-82.75
+1.5	-89.25	-93.67	-90.19	-91.89	-95.64	-90.78	-95.76	-94.02	-98.68
+2.0	-87.68	-89.64	-96.63	-100.40	-98.78	-94.10	-103.10	-102.14	-103.00
+2.5	-96.57	-96.78	-103.24	-99.80	-103.42	-100.01	-103.91	-104.82	-100.37
+3.0	-104.65	-105.19	-104.37	-107.84	-105.07	-105.46	-108.87	-108.65	-104.79
+3.5	-104.55	-104.85	-103.13	-107.43	-109.08	-107.34	-109.22	-109.91	-105.47
+4.0	-106.81	-107.15	-109.25	-110.97	-105.89	-110.82	-109.65	-109.27	-107.19
+4.5	-109.70	-104.78	-111.35	-108.63	-109.79	-107.34	-105.46	-111.31	-102.44
+5.0	-108.66	-106.69	-113.23	-107.42	-112.64	-113.07	-114.55	-114.96	-109.89

Note 5: Step size 125 kHz

Note 6: All spurs are referenced to carrier signal (n=0).



IF/RF MICROWAVE COMPONENTS • ISO 9001 ISO 14001 AS9100 CERTIFIED RoHS compliant
 P.O. Box 350166, Brooklyn, New York 11235-0003 (718) 934-4500 Fax (718) 332-4661



The Design Engineers Search Engine finds the model you need, Instantly • For detailed performance specs & shopping online see



Notes: 1. Performance and quality attributes and conditions not expressly stated in this specification sheet are intended to be excluded and do not form a part of this specification sheet. 2. Electrical specifications and performance data contained herein are based on Mini-Circuit's applicable established test performance criteria and measurement instructions. 3. The parts covered by this specification sheet are subject to Mini-Circuits standard limited warranty and terms and conditions (collectively, "Standard Terms"); Purchasers of this part are entitled to the rights and benefits contained therein. For a full statement of the Standard Terms and the exclusive rights and remedies thereunder, please visit Mini-Circuits' website at www.minicircuits.com/MCLStore/terms.jsp.

Typical Performance Curves

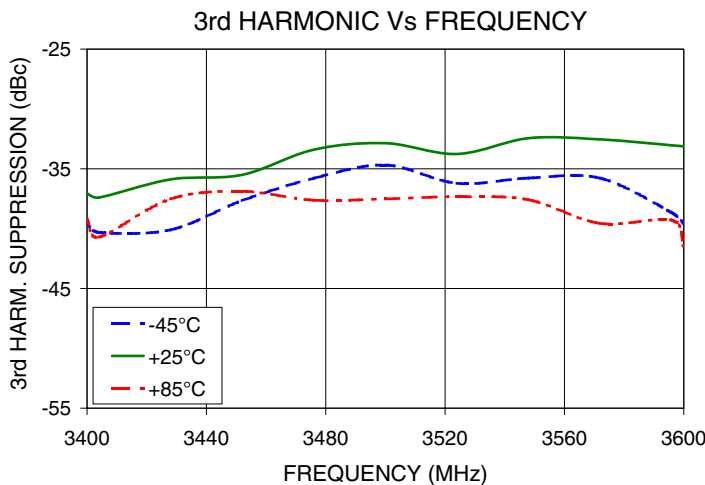
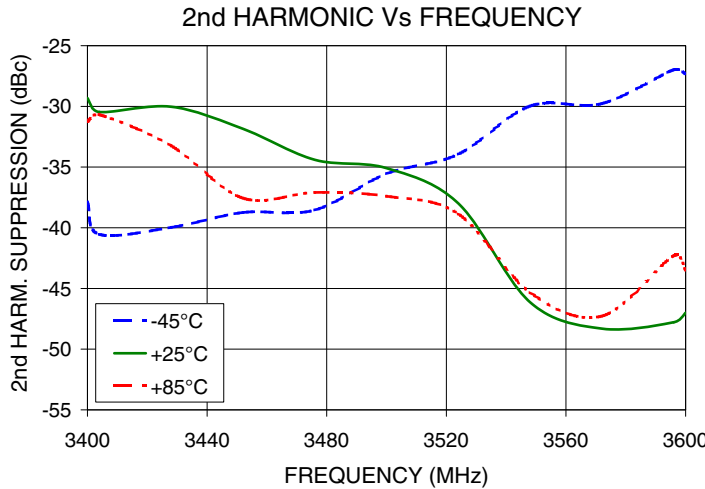
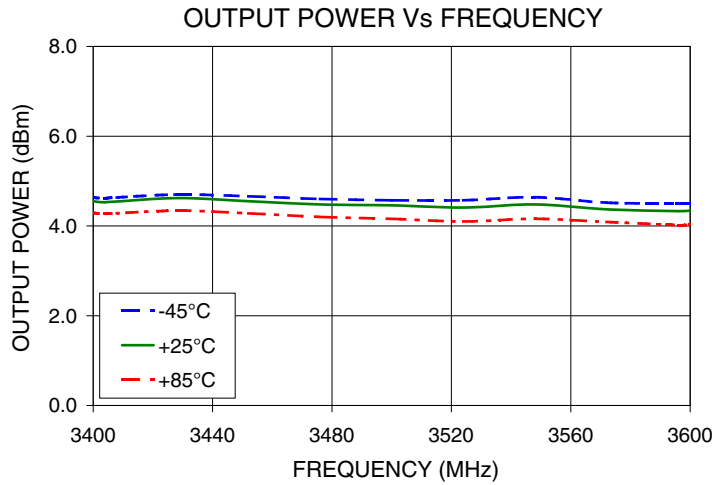

IF/RF MICROWAVE COMPONENTS • ISO 9001 ISO 14001 AS9100 CERTIFIED RoHS compliant
 P.O. Box 350166, Brooklyn, New York 11235-0003 (718) 934-4500 Fax (718) 332-4661



The Design Engineers Search Engine finds the model you need, Instantly • For detailed performance specs & shopping online see



Notes: 1. Performance and quality attributes and conditions not expressly stated in this specification sheet are intended to be excluded and do not form a part of this specification sheet. 2. Electrical specifications and performance data contained herein are based on Mini-Circuit's applicable established test performance criteria and measurement instructions. 3. The parts covered by this specification sheet are subject to Mini-Circuits standard limited warranty and terms and conditions (collectively, "Standard Terms"); Purchasers of this part are entitled to the rights and benefits contained therein. For a full statement of the Standard Terms and the exclusive rights and remedies thereunder, please visit Mini-Circuits' website at www.minicircuits.com/MCLStore/terms.jsp.

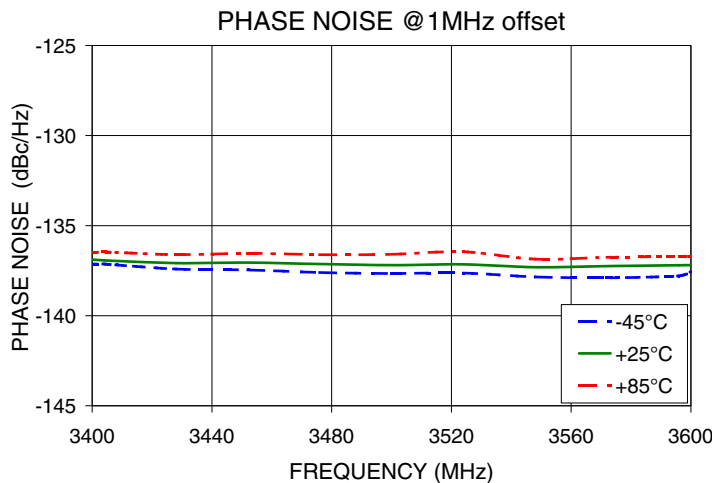
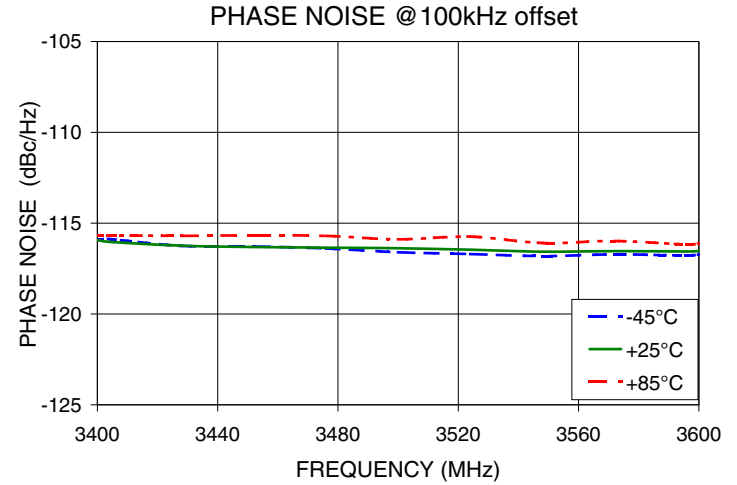
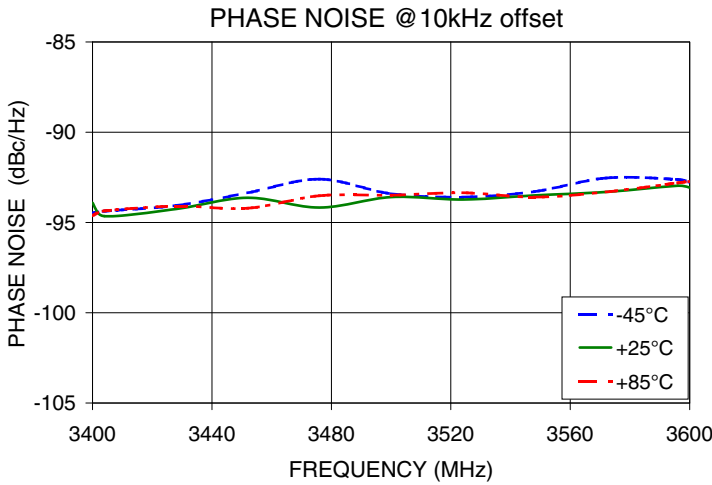
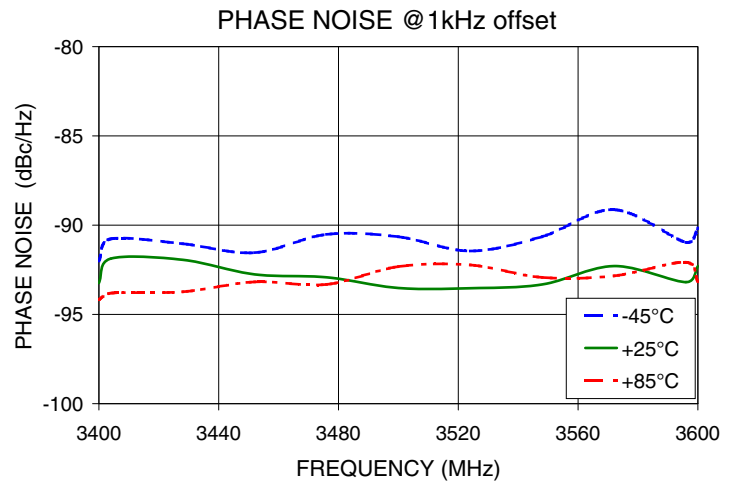
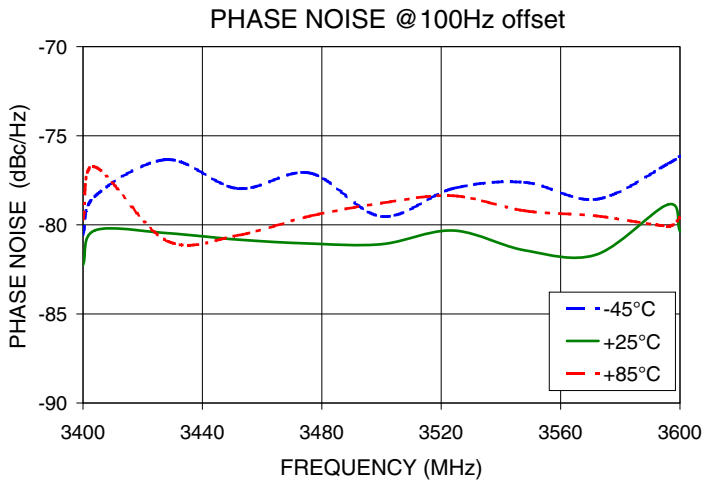

IF/RF MICROWAVE COMPONENTS • ISO 9001 ISO 14001 AS9100 CERTIFIED RoHS compliant
 P.O. Box 350166, Brooklyn, New York 11235-0003 (718) 934-4500 Fax (718) 332-4661



The Design Engineers Search Engine finds the model you need, Instantly • For detailed performance specs & shopping online see



Notes: 1. Performance and quality attributes and conditions not expressly stated in this specification sheet are intended to be excluded and do not form a part of this specification sheet. 2. Electrical specifications and performance data contained herein are based on Mini-Circuit's applicable established test performance criteria and measurement instructions. 3. The parts covered by this specification sheet are subject to Mini-Circuits standard limited warranty and terms and conditions (collectively, "Standard Terms"); Purchasers of this part are entitled to the rights and benefits contained therein. For a full statement of the Standard Terms and the exclusive rights and remedies thereunder, please visit Mini-Circuits' website at www.minicircuits.com/MCLStore/terms.jsp.

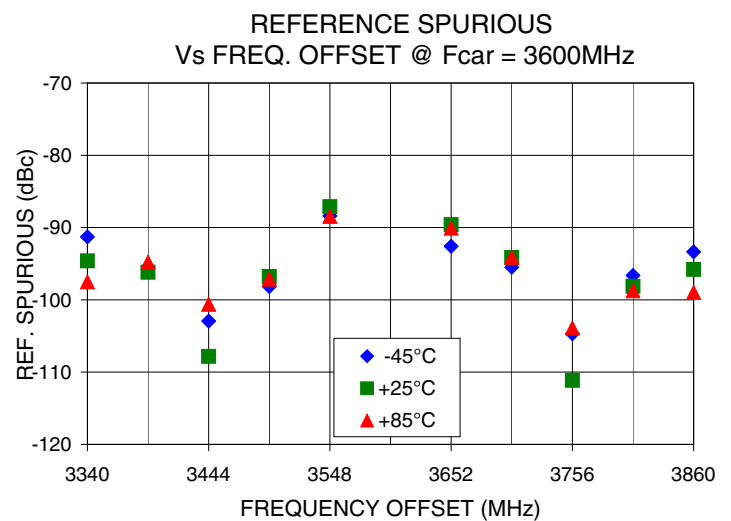
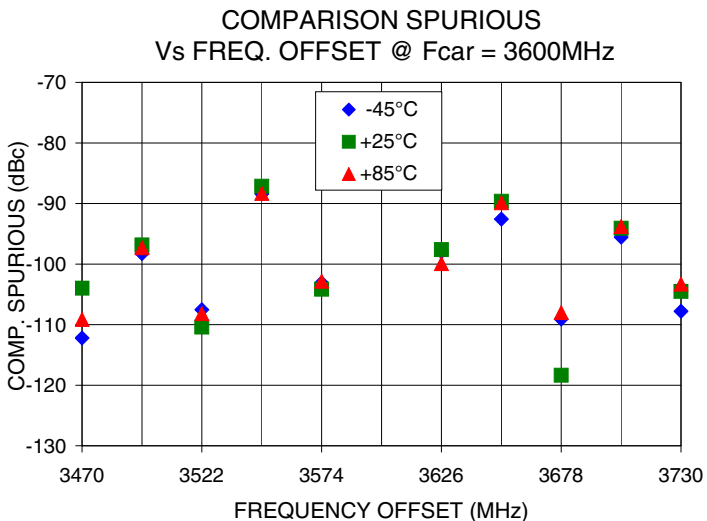
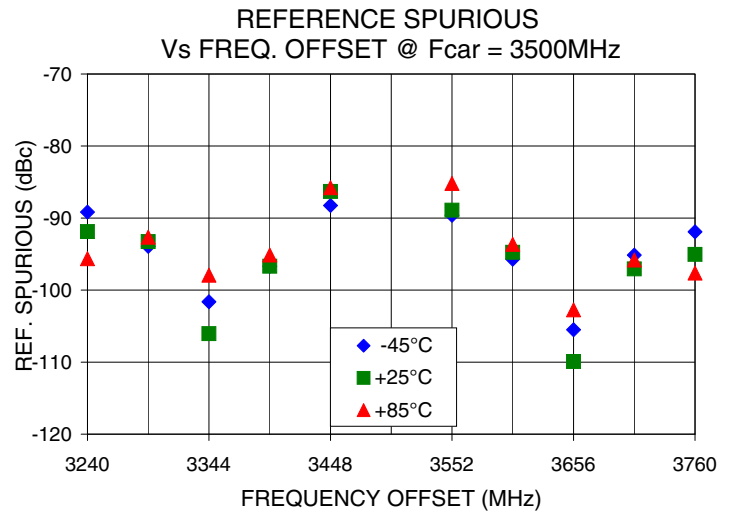
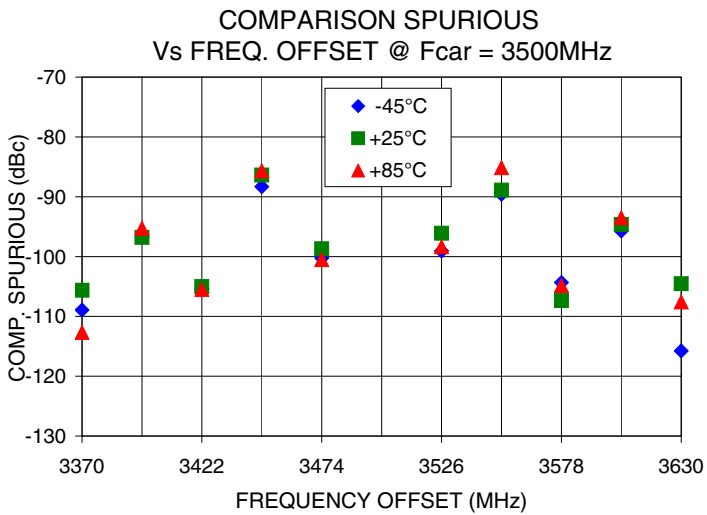
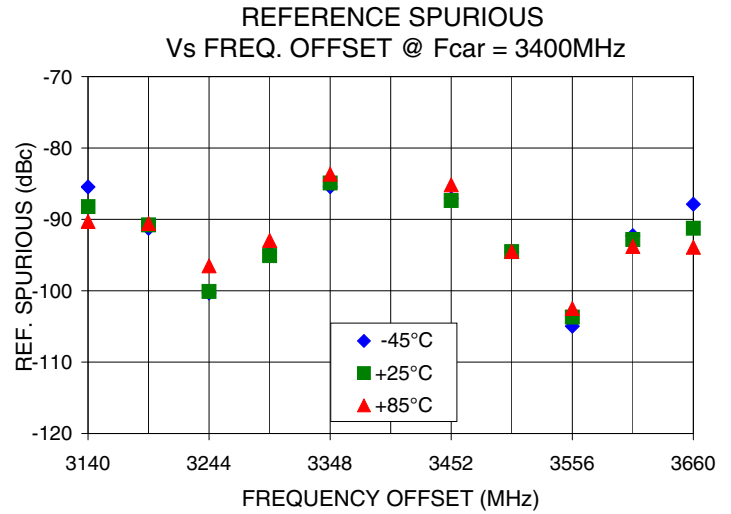
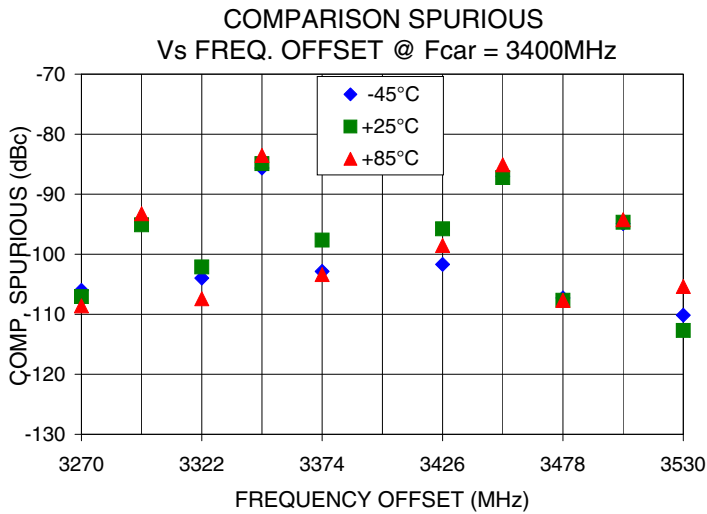

IF/RF MICROWAVE COMPONENTS • ISO 9001 ISO 14001 AS9100 CERTIFIED RoHS compliant
P.O. Box 350166, Brooklyn, New York 11235-0003 (718) 934-4500 Fax (718) 332-4661



The Design Engineers Search Engine finds the model you need, Instantly • For detailed performance specs & shopping online see



Notes: 1. Performance and quality attributes and conditions not expressly stated in this specification sheet are intended to be excluded and do not form a part of this specification sheet. 2. Electrical specifications and performance data contained herein are based on Mini-Circuit's applicable established test performance criteria and measurement instructions. 3. The parts covered by this specification sheet are subject to Mini-Circuits standard limited warranty and terms and conditions (collectively, "Standard Terms"); Purchasers of this part are entitled to the rights and benefits contained therein. For a full statement of the Standard Terms and the exclusive rights and remedies thereunder, please visit Mini-Circuits' website at www.minicircuits.com/MCLStore/terms.jsp.

0.5 STEP SIZE & STEP SIZE SPURIOUS
Vs FREQ. OFFSET @ Fcar = 3400MHz

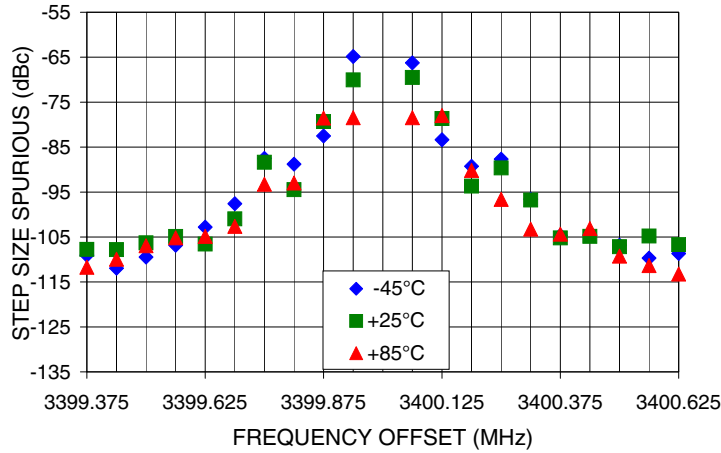

0.5 STEP SIZE & STEP SIZE SPURIOUS
Vs FREQ. OFFSET @ Fcar = 3500MHz

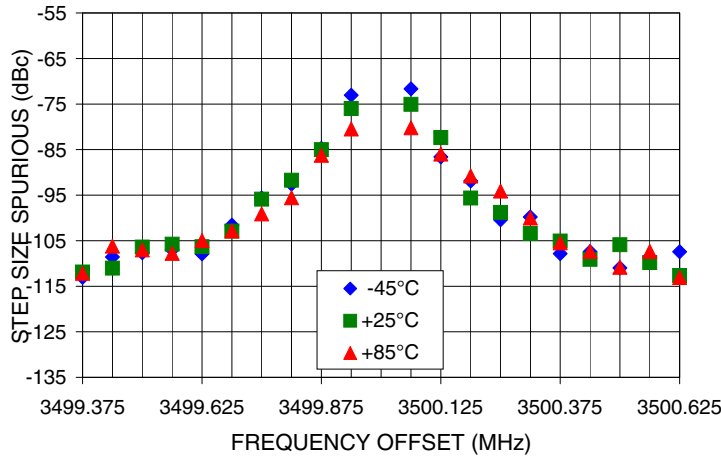

0.5 STEP SIZE & STEP SIZE SPURIOUS
Vs FREQ. OFFSET @ Fcar = 3600MHz

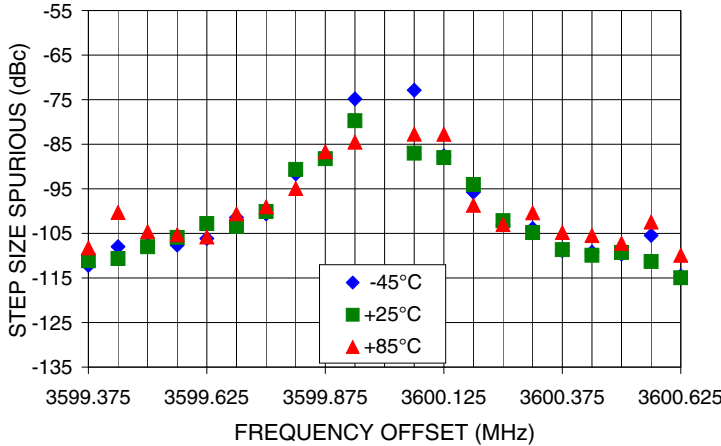

IF/RF MICROWAVE COMPONENTS • ISO 9001 ISO 14001 AS9100 CERTIFIED RoHS compliant
P.O. Box 350166, Brooklyn, New York 11235-0003 (718) 934-4500 Fax (718) 332-4661



The Design Engineers Search Engine finds the model you need, Instantly • For detailed performance specs & shopping online see



Notes: 1. Performance and quality attributes and conditions not expressly stated in this specification sheet are intended to be excluded and do not form a part of this specification sheet. 2. Electrical specifications and performance data contained herein are based on Mini-Circuit's applicable established test performance criteria and measurement instructions. 3. The parts covered by this specification sheet are subject to Mini-Circuits standard limited warranty and terms and conditions (collectively, "Standard Terms"); Purchasers of this part are entitled to the rights and benefits contained therein. For a full statement of the Standard Terms and the exclusive rights and remedies thereunder, please visit Mini-Circuits' website at www.minicircuits.com/MCLStore/terms.jsp.

Pin Configuration

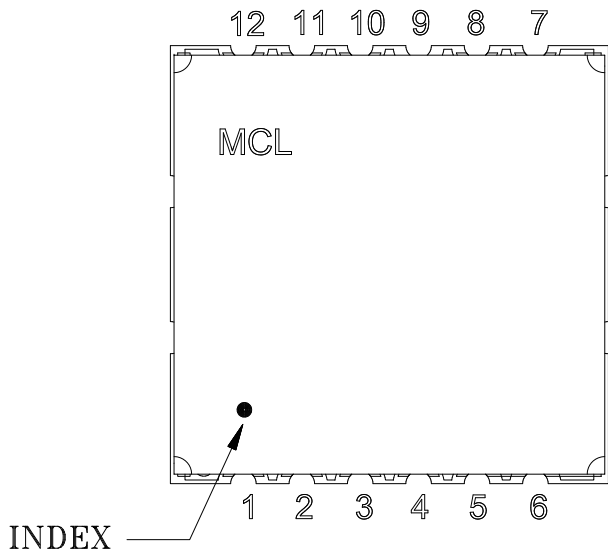

Pin Connection

Pin Number	Function
1	CLOCK
2	DATA
3	ENABLED
4	REF IN
5	GND
6	GND
7	VCC VCO
8	GND
9	RF OUT
10	GND
11	LOCK DET
12	VCC PLL

Recommended Application Circuit

Note: REF IN and RF OUT ports are internally AC coupled.

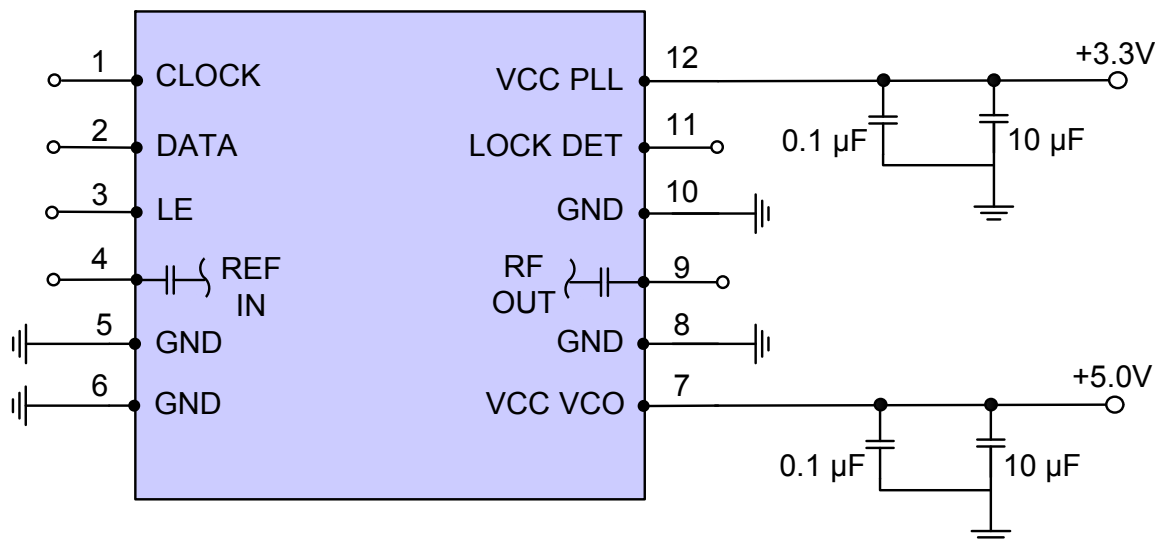

IF/RF MICROWAVE COMPONENTS • ISO 9001 ISO 14001 AS9100 CERTIFIED RoHS compliant
 P.O. Box 350166, Brooklyn, New York 11235-0003 (718) 934-4500 Fax (718) 332-4661



The Design Engineers Search Engine finds the model you need, Instantly • For detailed performance specs & shopping online see



Notes: 1. Performance and quality attributes and conditions not expressly stated in this specification sheet are intended to be excluded and do not form a part of this specification sheet. 2. Electrical specifications and performance data contained herein are based on Mini-Circuit's applicable established test performance criteria and measurement instructions. 3. The parts covered by this specification sheet are subject to Mini-Circuits standard limited warranty and terms and conditions (collectively, "Standard Terms"); Purchasers of this part are entitled to the rights and benefits contained therein. For a full statement of the Standard Terms and the exclusive rights and remedies thereunder, please visit Mini-Circuits' website at www.minicircuits.com/MCLStore/terms.jsp.

Device Marking

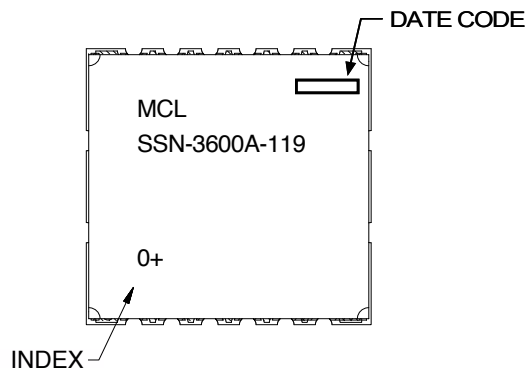

Additional Detailed Technical Information

Additional information is available on our web site. To access this information enter the model number on our web site home page.

Case Style: KJ1367

Tape & Reel: TR-F95

Suggested Layout for PCB Design: PL-317

Evaluation Board: TB-552+

Environment Ratings: ENV03T2



IF/RF MICROWAVE COMPONENTS • ISO 9001 ISO 14001 AS9100 CERTIFIED RoHS compliant
P.O. Box 350166, Brooklyn, New York 11235-0003 (718) 934-4500 Fax (718) 332-4661



The Design Engineers Search Engine finds the model you need, Instantly • For detailed performance specs & shopping online see



Notes: 1. Performance and quality attributes and conditions not expressly stated in this specification sheet are intended to be excluded and do not form a part of this specification sheet. 2. Electrical specifications and performance data contained herein are based on Mini-Circuit's applicable established test performance criteria and measurement instructions. 3. The parts covered by this specification sheet are subject to Mini-Circuits standard limited warranty and terms and conditions (collectively, "Standard Terms"); Purchasers of this part are entitled to the rights and benefits contained therein. For a full statement of the Standard Terms and the exclusive rights and remedies thereunder, please visit Mini-Circuits' website at www.minicircuits.com/MCLStore/terms.jsp.