

Low Noise 2670 to 2700 MHz

Features

- Linear tuning characteristics
- Low phase noise
- Low pulling
- Low pushing
- Aqueous washable

Applications

- Wireless communications
- Point-to-point



CASE STYLE: CK605
PRICE: \$ 25.95 ea. QTY (5-49)

+ RoHS compliant in accordance with EU Directive (2002/95/EC)

The +Suffix has been added in order to identify RoHS Compliance. See our web site for RoHS Compliance methodologies and qualifications.

Electrical Specifications

MODEL NO.	FREQ. (MHz)		POWER OUTPUT (dBm)	PHASE NOISE dBc/Hz SSB at offset frequencies, kHz				TUNING					NON HARMONIC SPURIOUS (dBc)	HARMONICS (dBc)		PULLING pk-pk @ 12 dB (MHz)	PUSHING (MHz/V)	DC OPERATING POWER	
	Min.	Max.		Typ.	1	10	100	1000	VOLTAGE RANGE (V)	SENSI-TIVITY (MHz/V)	PORT CAP (pF)	3 dB MODULATION BANDWIDTH (MHz)		Typ.	Typ.			Typ.	Typ.
ROS-2710C-119+	2670	2700	+3	-80	-110	-131	-151	0.5	5.5	16	15	140	-90	-14	-	0.3	0.2	5	35

Pin Connections

RF OUT	10
VCC	14
V-TUNE	2
GROUND	1,3,4,5,6,7,8,9,11,12,13,15,16

Maximum Ratings

Operating Temperature	-55°C to 85°C
Storage Temperature	-55°C to 100°C
Absolute Max. Supply Voltage (Vcc)	7V
Absolute Max. Tuning Voltage (Vtune)	7V
All specifications	50 ohm system

Permanent damage may occur if any of these limits are exceeded.

Outline Drawing

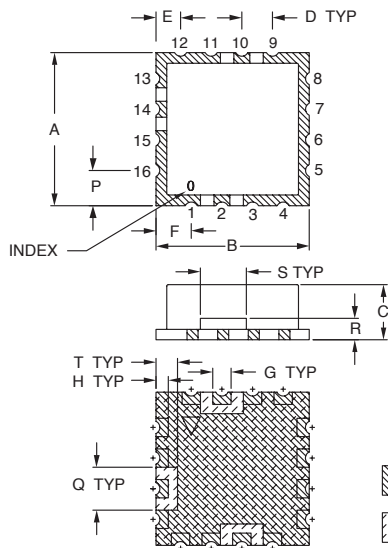

PCB Land Pattern

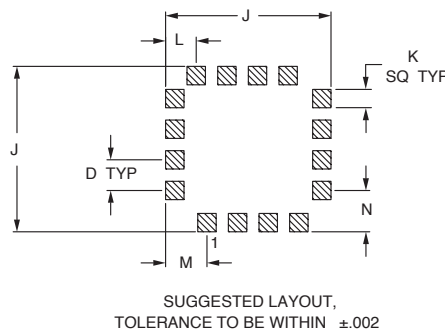

Demo Board MCL P/N: TB-10 Suggested PCB Layout (PL-012)

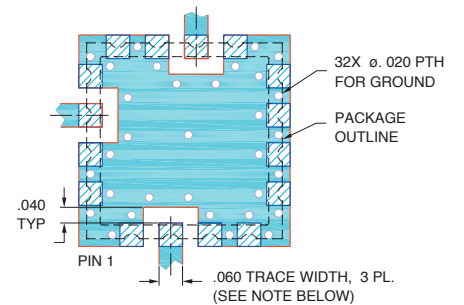

- NOTES:
1. TRACE WIDTH IS SHOWN FOR RF4 WITH DIELECTRIC THICKNESS .030" ± .002"; COPPER: 1/2 OZ. EACH SIDE. FOR OTHER MATERIALS TRACE WIDTH MAY NEED TO BE MODIFIED.
 2. BOTTOM SIDE OF THE PCB IS CONTINUOUS GROUND PLANE.
- DENOTES PCB COPPER LAYOUT WITH SMOBC (SOLDER MASK OVER BARE COPPER)
 - DENOTES COPPER LAND PATTERN FREE OF SOLDER MASK

Outline Dimensions (inch/mm)

A	B	C	D	E	F	G	H	J	K	L	M	N	P	Q	R	S	T	wt.
.500	.500	.180	.100	.080	.115	.060	.040	.540	.060	.100	.135	.135	.115	.140	.070	.150	.070	grams
12.70	12.70	4.57	2.54	2.03	2.92	1.52	1.02	13.72	1.52	2.54	3.43	3.43	2.92	3.56	1.78	3.81	1.78	1.0

Performance Data & Curves*

ROS-2710C-119+

V TUNE	TUNE SENS (MHz/V)	FREQUENCY (MHz)			POWER OUTPUT (dBm)			Icc (mA)	HARMONICS (dBc)			FREQ. PUSH (MHz/V)	FREQ. PULL (MHz)	PHASE NOISE (dBc/Hz) at offsets				FREQ OFFSET (KHz)	PHASE NOISE at 2690 MHz (dBc/Hz)
		-55°C	+25°C	+85°C	-55°C	+25°C	+85°C		F2	F3	F4			1kHz	10kHz	100kHz	1MHz		
0.00	23.74	2638.3	2631.1	2624.6	2.39	3.11	3.27	22.70	-14.6	-32.0	-29.6	0.25	0.62	-79.9	-109.2	-131.5	-150.6	1.0	-82.76
0.25	21.09	2643.9	2637.1	2630.8	2.41	3.11	3.25	22.78	-14.5	-32.0	-29.7	0.04	0.61	-80.1	-109.6	-131.3	-151.8	2.0	-92.06
0.50	19.45	2649.0	2642.3	2636.3	2.44	3.12	3.24	22.85	-14.3	-32.1	-29.1	0.08	0.57	-81.2	-110.0	-132.0	-151.7	4.2	-101.53
0.75	18.34	2653.7	2647.2	2641.3	2.45	3.14	3.24	22.92	-14.3	-32.4	-28.2	0.14	0.49	-80.4	-110.3	-132.3	-151.3	6.0	-105.70
1.00	17.57	2658.2	2651.8	2645.9	2.47	3.17	3.26	22.98	-14.5	-32.7	-27.6	0.18	0.40	-80.6	-110.1	-131.6	-151.3	8.5	-109.61
1.50	16.59	2666.7	2660.4	2654.7	2.56	3.20	3.29	23.10	-14.7	-32.7	-28.1	0.23	0.20	-80.4	-110.0	-131.7	-152.0	10.0	-111.29
1.75	16.29	2670.8	2664.6	2658.9	2.61	3.23	3.30	23.16	-14.7	-32.4	-28.4	0.23	0.11	-79.4	-110.1	-131.9	-152.7	24.9	-120.52
2.00	16.07	2674.8	2668.6	2663.0	2.67	3.28	3.32	23.22	-14.6	-32.2	-28.2	0.24	0.03	-78.3	-110.0	-132.6	-151.9	42.5	-125.07
2.25	15.92	2678.7	2672.7	2667.0	2.69	3.33	3.35	23.27	-14.4	-32.1	-27.6	0.23	0.10	-79.7	-110.1	-132.2	-153.1	60.7	-127.67
2.50	15.81	2682.7	2676.6	2671.0	2.71	3.37	3.40	23.33	-14.2	-32.2	-26.9	0.22	0.19	-79.5	-110.2	-131.1	-151.1	86.7	-131.58
2.75	15.74	2686.6	2680.6	2675.0	2.73	3.39	3.44	23.39	-13.9	-32.2	-26.6	0.21	0.28	-79.8	-110.1	-131.9	-150.7	100.0	-132.49
3.00	15.69	2690.5	2684.5	2679.0	2.74	3.42	3.46	23.45	-13.7	-32.2	-27.1	0.18	0.36	-79.9	-110.0	-133.0	-152.2	148.1	-136.22
3.25	15.66	2694.4	2688.5	2682.9	2.75	3.44	3.48	23.51	-13.5	-32.1	-27.5	0.16	0.44	-82.0	-111.3	-132.6	-153.0	211.6	-139.87
3.50	15.64	2698.3	2692.4	2686.9	2.76	3.46	3.50	23.57	-13.4	-32.1	-27.4	0.12	0.51	-81.8	-111.1	-132.7	-152.7	302.4	-142.92
3.75	15.63	2702.1	2696.3	2690.8	2.77	3.48	3.52	23.62	-13.5	-31.9	-26.8	0.08	0.56	-80.1	-110.1	-131.6	-153.3	432.2	-146.13
4.00	15.61	2706.0	2700.2	2694.7	2.77	3.49	3.54	23.68	-13.6	-31.6	-26.0	0.04	0.59	-80.6	-110.1	-132.2	-151.6	507.5	-147.29
4.50	15.52	2713.7	2708.0	2702.6	2.75	3.50	3.57	23.81	-13.9	-31.6	-25.4	0.08	0.64	-82.1	-109.6	-131.9	-150.9	606.7	-149.13
4.75	15.44	2717.6	2711.9	2706.5	2.74	3.49	3.58	23.87	-14.0	-31.7	-25.7	0.16	0.64	-80.8	-109.5	-131.3	-153.1	712.4	-149.97
5.00	15.31	2721.4	2715.7	2710.4	2.72	3.47	3.58	23.93	-14.1	-31.7	-25.9	0.24	0.61	-79.9	-109.2	-130.8	-152.2	851.6	-151.40
5.50	14.86	2728.9	2723.3	2718.1	2.68	3.42	3.55	24.06	-13.6	-31.7	-25.3	0.46	0.47	-79.7	-108.6	-131.4	-151.6	1000.0	-152.40

*at 25°C unless mentioned otherwise

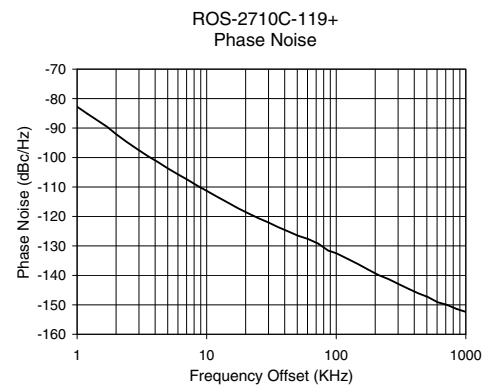
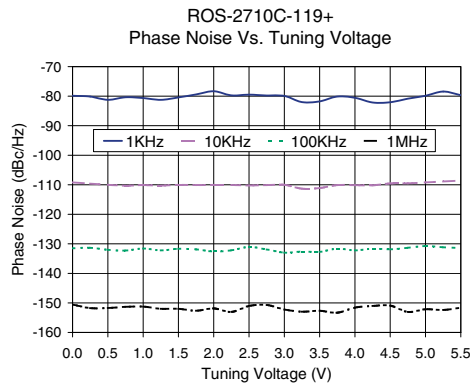
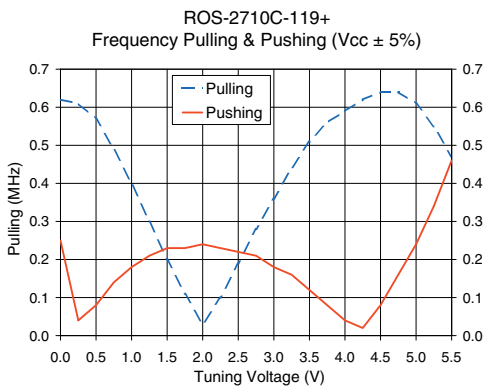
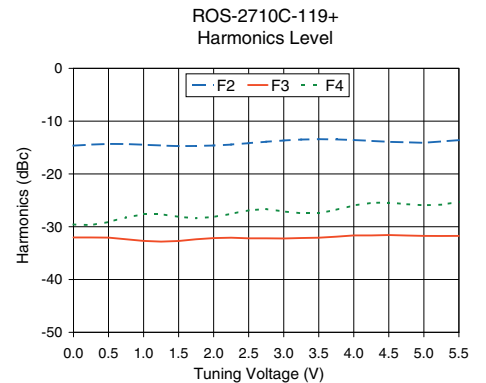
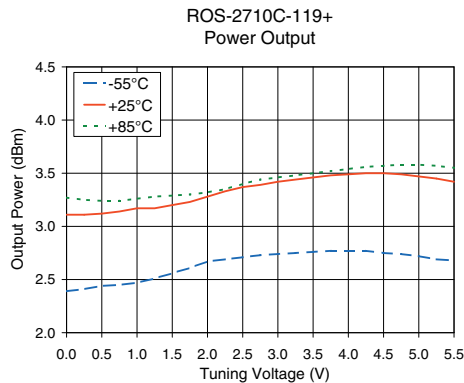
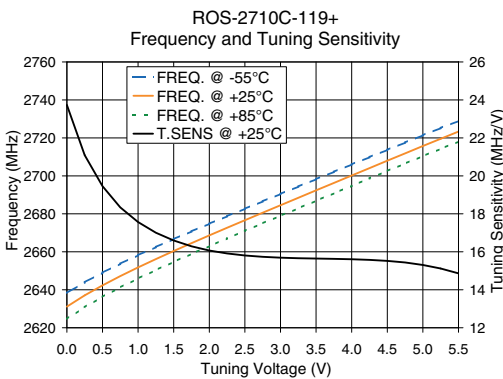

For detailed performance specs & shopping online see web site

P.O. Box 350166, Brooklyn, New York 11235-0003 (718) 934-4500 Fax (718) 332-4661 The Design Engineers Search Engine Provides ACTUAL Data Instantly at minicircuits.com

Notes: 1. Performance and quality attributes and conditions not expressly stated in this specification sheet are intended to be excluded and do not form a part of this specification sheet. 2. Electrical specifications and performance data contained herein are based on Mini-Circuit's applicable established test performance criteria and measurement instructions. 3. The parts covered by this specification sheet are subject to Mini-Circuits standard limited warranty and terms and conditions (collectively, "Standard Terms"); Purchasers of this part are entitled to the rights and benefits contained therein. For a full statement of the Standard Terms and the exclusive rights and remedies thereunder, please visit Mini-Circuits' website at www.minicircuits.com/MCLStore/terms.jsp.