

Ultra Low Noise, High IP3 Monolithic Amplifier Die

PMA2-33LN-D+

50Ω 0.4 to 3.0 GHz

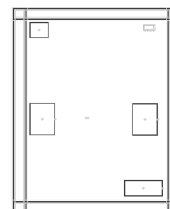

The Big Deal

- Ultra Low Noise Figure, 0.47 dB
- High Gain, High IP3

Product Overview

Mini-Circuits PMA2-33LN-D+ is an E-PHEMT based, ultra-low noise MMIC amplifier die with a unique combination of low noise and high IP3, making this amplifier ideal for sensitive, high-dynamic range receiver applications. This design operates on a single 3V supply, is well matched for 50Ω systems.

Key Features

Feature	Advantages
Ultra Low Noise, 0.47 dB at 0.9 GHz	Enables lower system noise figure performance.
High IP3, • +33.8 dBm at 0.9 GHz and • +38.5 dBm at 3 GHz	Combination of low noise and high IP3 makes this MMIC amplifier ideal for use in low noise receiver front end (RFE) as it gives the user advantages of sensitivity & two-tone IM performance at both ends of the dynamic range.
Low operating voltage, 3V	Achieves high IP3 using lower voltage compared to other devices of its kind.
Max input power • 27 dBm (5 minutes) • 14 to +22 dBm (Continuous)	Ruggedized design provides high power handling for input powers common at receiver inputs, eliminating the need for an external limiter in most cases
High reliability	Low signal operating current of 56 mA nominal maintains junction temperatures typically below 93°C at 85°C ground lead temperature.



Ultra Low Noise, High IP3 Monolithic Amplifier Die

PMA2-33LN-D+

50Ω 0.4 to 3.0 GHz

Product Features

- Ultra Low Noise figure, 0.47 dB at 0.9 GHz
- High IP3, 34 dBm typ. at 0.9 GHz, +39 dBm at 3 GHz
- High Pout, P1dB 17.6 dBm typ. at 0.9 GHz

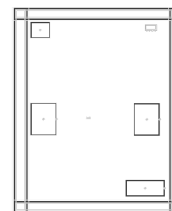

Typical Applications

- Base station infrastructure
- Portable Wireless
- LTE
- GPS
- GSM
- Airborne radar

+RoHS Compliant

The +Suffix identifies RoHS Compliance. See our web site for RoHS Compliance methodologies and qualifications

Ordering Information: Refer to Last Page

General Description

The PMA2-33LN-D+ (RoHS compliant) amplifier die is fabricated using 0.25 μm E-PHEMT technology and offers extremely high dynamic range with ultra low noise figure and good input and output return loss.

simplified schematic & pad description

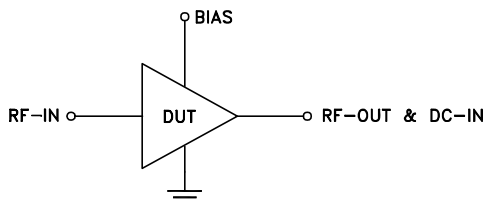

Pad Function	Description (See Figure 1)
RF-IN	Connects to RF input via C1 and Bias Pad via L1
RF-OUT & DC-IN	Connects to RF out via C2 and V_S via L2 & R2
Bias	Connects to Supply voltage (V_S) via R1 & Rb
Ground	Connects to ground

Electrical Specifications¹ at 25°C and 3V, unless noted

Parameter	Condition (GHz)	Min.	Typ.	Max.	Units
Frequency range		0.4		3.0	GHz
Noise figure	0.4 0.9 1.5 2.0 3.0		0.56 0.47 0.55 0.53 0.79		dB
Gain	0.4 0.9 1.5 2.0 3.0		23.7 18.4 14.2 11.8 8.4		dB
Input return loss	0.4 0.9 1.5 2.0 3.0		10.5 13.7 15.6 16.5 17.5		dB
Output return loss	0.4 0.9 1.5 2.0 3.0		17.4 29.3 24.5 22.8 23.6		dB
Output power @ 1dB compression	0.4 0.9 1.5 2.0 3.0		17.0 17.6 18.1 18.0 18.6		dBm
Output IP3	0.4 0.9 1.5 2.0 3.0		30.5 33.8 35.3 35.4 38.5		dBm
Device operating voltage			3.0		V
Device operating current at 3V ²		—	58	67	mA
Device current variation vs voltage at 25°C			0.025		mA/mV
Thermal resistance, junction-to-ground			54		°C/W

1. Measured on Mini-Circuits Die Characterization test board. See Characterization Test Circuit (Fig. 1)

2. Current increases at P1dB

Absolute Maximum Ratings^{3,4}

Parameter	Ratings
Operating Temperature (ground lead)	-40°C to 85°C
Junction Temperature	150°C
Total Power Dissipation	0.5 W
Input Power (CW), Vd=3V	+27dBm (5minutes max) +14 dBm to 1.5 GHz and +22 dBm over 1.5 to 3 GHz (continuous)
DC Voltage	5.5 V

3. Permanent damage may occur if any of these limits are exceeded.

Electrical maximum ratings are not intended for continuous normal operation.

4. Die performance measured in industry standard 2x2mm 8-lead package.

Recommended Application and Characterization Test Circuit

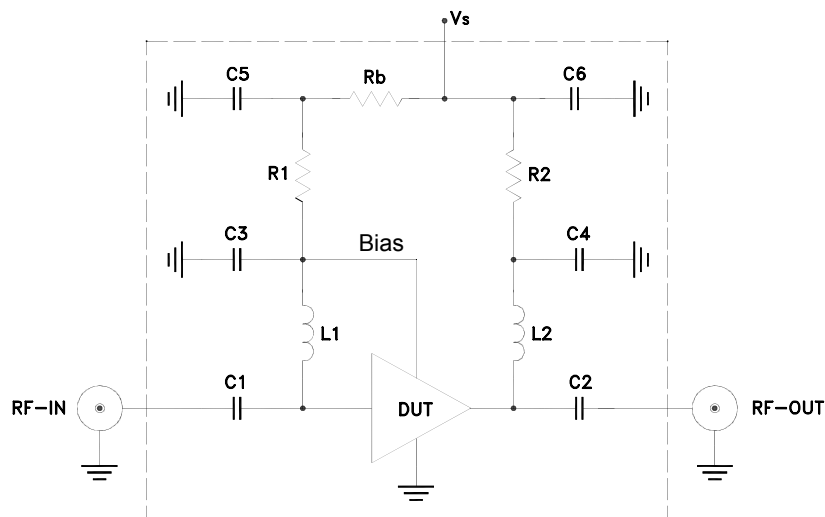

Component	Value	Size
C1, C2	100pF	0402
C3, C6	4.7μF	0402
C4	33pF	0402
C5	Not Used	—
L1, L2	33nH	0402
R1	0Ω	0402
R2	10Ω	0603
Rb	4.02kΩ	0402

Fig 1. Application and Characterization circuit
 Note: This block diagram is used for characterization. (DUT soldered on Mini-Circuits Characterization test board TB-736+)
 Gain, Return loss, Output power at 1dB compression (P1 dB), output IP3 (OIP3) and noise figure measured using Agilent's N5242A PNA-X microwave network analyzer.

Conditions:

1. Gain and Return loss: Pin= -25dBm
2. Output IP3 (OIP3): Two tones, spaced 1 MHz apart, 0 dBm/tone at output.

Die Layout

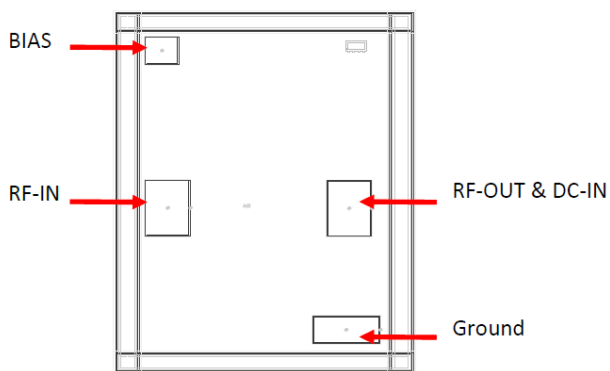

Fig 2. Die Layout

Bonding Pad Position

(Dimensions in μm, Typical)

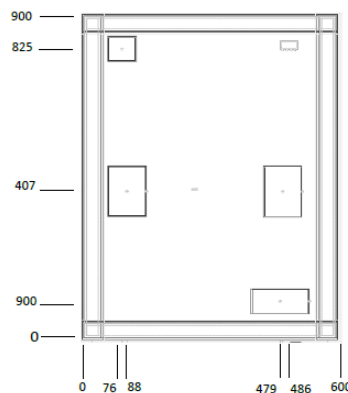

Fig 3. Bonding Pad Positions

Critical Dimensions

Parameter	Values
Die Thickness, μm	100
Die Width, μm	600
Die Length, μm	900
Bond Pad Size (RF-IN, RF-OUT & DC-IN), μm	150 x 150
Bond Pad Size (Bias), μm	75 x 75
Bond Pad Size (Ground pad), μm	150 x 75

Assembly and Handling Procedure

1. Storage
Dice should be stored in a dry nitrogen purged desiccators or equivalent.
2. ESD
MMIC EPHEMPT amplifier dice are susceptible to electrostatic and mechanical damage. Die are supplied in antistatic protected material, which should be opened in clean room conditions at an appropriately grounded anti-static workstation. Devices need careful handling using correctly designed collets, vacuum pickup tips or sharp antistatic tweezers to deter ESD damage to dice.
3. Die Attach
The die mounting surface must be clean and flat. Using conductive silver filled epoxy, recommended epoxies are DieMat DM6030HK-PT/H579 or Ablestik 84-1LMISR4. Apply sufficient epoxy to meet required epoxy bond line thickness, epoxy fillet height and epoxy coverage around total die periphery. Parts shall be cured in a nitrogen filled atmosphere per manufacturer's cure condition. It is recommended to use antistatic die pick up tools only.
4. Wire Bonding
Bond pad openings in the surface passivation above the bond pads are provided to allow wire bonding to the dice gold bond pads. Thermoasonic bonding is used with minimized ultrasonic content. Bond force, time, ultrasonic power and temperature are all critical parameters. Suggested wire is pure gold, 1 mil diameter. Bonds must be made from the bond pads on the die to the package or substrate. All bond wires should be kept as short as low as reasonable to minimize performance degradation due to undesirable series inductance.

Assembly Diagram

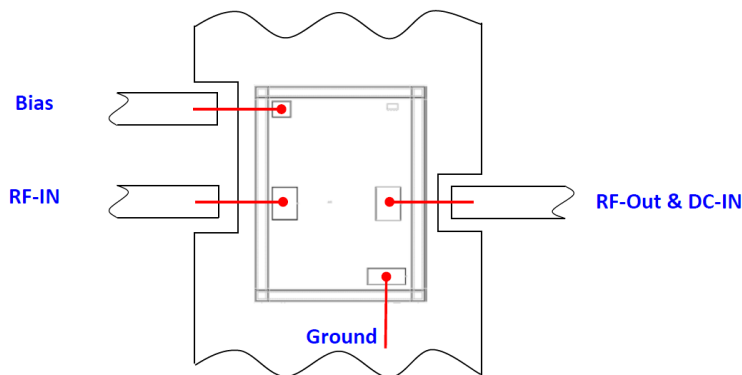

Recommended Wire Length, Typical

Wire	Wire Length (mm)	Wire Loop Height (mm)
RF-IN, Bias	0.80	0.15
RF-OUT & DC-IN	1.00	0.15
GROUND	0.90	0.15

RF Reference Plane - No port extension

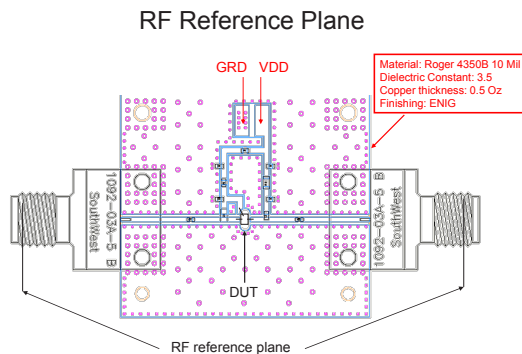

Additional Detailed Technical Information <i>additional information is available on our dash board.</i>	
Performance Data	Data Table
	Swept Graphs
	S-Parameter (S2P Files) Data Set with and without port extension(.zip file)
Case Style	Die
Die Ordering and packaging information	Quantity, Package Model No.
	Small, Gel - Pak: 10,50,100 KGD* PMA2-33LN-DG+ Medium†, Partial wafer: KGD*<5K PMA2-33LN-DP+ Large†, Full Wafer PMA2-33LN-DF+
	†Available upon request contact sales representative
	Refer to AN-60-067
Environmental Ratings	ENV-80

*Known Good Dice ("KGD") means that the dice in question have been subjected to Mini-Circuits DC test performance criteria and measurement instructions and that the parametric data of such dice fall within a predefined range. While DC testing is not definitive, it does help to provide a higher degree of confidence that dice are capable of meeting typical RF electrical parameters specified by Mini-Circuits.

ESD Rating**

Human Body Model (HBM): Class 1A (250 to <500V) in accordance with ANSI/ESD STM 5.1 - 2001

Machine Model (MM): Class M1 (pass 25V) in accordance with ANSI/ESD STM5.2-1999

** Tested in industry standard 2x2mm, 8-lead plastic package.

Additional Notes

- A. Performance and quality attributes and conditions not expressly stated in this specification document are intended to be excluded and do not form a part of this specification document.
- B. Electrical specifications and performance data contained in this specification document are based on Mini-Circuit's applicable established test performance criteria and measurement instructions.
- C. The parts covered by this specification document are subject to Mini-Circuits standard limited warranty and terms and conditions (collectively, "Standard Terms"); Purchasers of this part are entitled to the rights and benefits contained therein. For a full statement of the Standard Terms and the exclusive rights and remedies thereunder, please visit Mini-Circuits' website at www.minicircuits.com/MCLStore/terms.jsp
- D. Mini-Circuits does not warrant the accuracy or completeness of the information, text, graphics and other items contained within this document and same are provided as an accommodation and on an "As is" basis, with all faults.
- E. Purchasers of this part are solely responsible for proper storing, handling, assembly and processing of Known Good Dice (including, without limitation, proper ESD preventative measures, die preparation, die attach, wire bonding and related assembly and test activities), and Mini-Circuits assumes no responsibility therefor or for environmental effects on Known Good Dice.
- F. Mini-Circuits and the Mini-Circuits logo are registered trademarks of Scientific Components Corporation d/b/a Mini-Circuits. All other third-party trademarks are the property of their respective owners. A reference to any third-party trademark does not constitute or imply any endorsement, affiliation, sponsorship, or recommendation by any such third-party of Mini-Circuits or its products.

