

Ultra Linear Low Noise

# Monolithic Amplifier Die

PGA-103-D+

50Ω 0.05 to 4 GHz

## The Big Deal

- Ultra High IP3
- Broadband High Dynamic Range

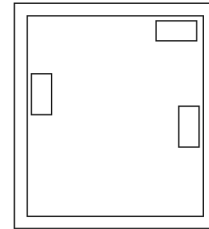

## Product Overview

PGA-103-D+ (RoHS compliant) is an advanced wideband amplifier die fabricated using E-PHEMT technology and offers extremely high dynamic range over a broad frequency range and with low noise figure. In addition, the PGA-103-D+ has good input and output return loss over a broad frequency range without the need for external matching components and has demonstrated excellent reliability.

## Key Features

Feature	Advantages
Broad Band: 0.05 to 4.0 GHz	Broadband covering primary wireless communications bands: Cellular, PCS, LTE, WiMAX
Ultra High IP3 Versus DC power Consumption: 42 dBm typical at 2 GHz at +5.0V Supply Voltage and only 97mA	The PGA-103-D+ provides excellent IP3 performance relative to device size and power consumption. The combination of the design and E-PHEMT Structure provides enhanced linearity over a broad frequency range as evidence in the IP3 being typically 20 dB above the P 1dB point. This feature makes this amplifier ideal for use in: <ul style="list-style-type: none"><li>• Driver amplifiers for complex waveform up converter paths</li><li>• Drivers in linearized transmit systems</li><li>• Secondary amplifiers in ultra High Dynamic range receivers</li></ul>
Low Noise Figure: 0.6 dB up to 1.0 GHz	A unique feature of the PGA-103-D+ which separates this design from all competitors is the low noise figure performance in combination with the high dynamic range.

# Ultra Linear Low Noise Monolithic Amplifier Die

## PGA-103-D+

50Ω 0.05 to 4 GHz

### Product Features

- 5V/3V operation
- High IP3, 42 dBm typ. at 2 GHz, Vd=5V
- Low Noise Figure, 0.6 at 1 GHz; 0.8 dB at 2 GHz
- Gain, 11.3 dB typ. at 2 GHz
- P1dB 22.3 dBm typ. at 2 GHz at Vd=5V
- Protected under US Patent 8,803,612

### Typical Applications

- Base station infrastructure
- Portable Wireless
- CATV & DBS
- MMDS & Wireless LAN
- LTE

### General Description

PGA-103-D+ (RoHS compliant) is an advanced wideband amplifier fabricated using E-PHEMT technology and offers extremely high dynamic range over a broad frequency range and with low noise figure. In addition, the PGA-103-D+ has good input and output return loss over a broad frequency range without the need for external matching components.

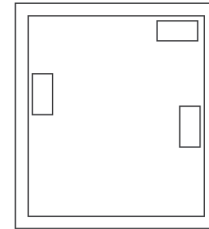

**+RoHS Compliant**

The +Suffix identifies RoHS Compliance. See our web site for RoHS Compliance methodologies and qualifications

Ordering Information: Refer to Last Page

### Simplified Schematic and Pad description

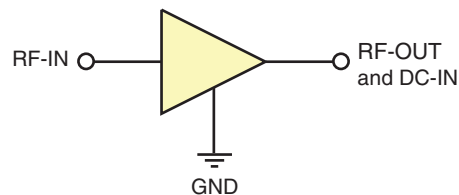

Pad	Description
RF IN	RF input pad. This pad requires the use of an external DC blocking capacitor chosen for the frequency of operation.
RF-OUT and DC-IN	RF output and bias pad. DC voltage is present on this pad; therefore a DC blocking capacitor is necessary for proper operation. An RF choke is needed to feed DC bias without loss of RF signal due to the bias connection, as shown in "Recommended Application Circuit", Fig. 2
GND	Connections to ground.

**Electrical Specifications<sup>1</sup> at 25°C, 50Ω unless noted**

Parameter	Condition (GHz)	Vd=5.0V			Vd=3V	Units
		Min.	Typ.	Max.	Typ.	
Frequency range		0.05		4.0	0.05-4.0	GHz
Gain	0.05		26.7		26.1	dB
	0.4		22.3		21.8	
	1.0		16.5		16.1	
	2.0		11.3		10.8	
	3.0		8.1		7.7	
	4.0		6.1		5.6	
Noise figure	0.05		0.4		0.3	dB
	0.4		0.7		0.7	
	1.0		0.6		0.6	
	2.0		0.8		0.8	
	3.0		1.4		1.4	
	4.0		1.6		1.5	
Input return loss	0.05		6.8		6.1	dB
	0.8		11.5		10.4	
	2.0		14.0		12.8	
	3.0		14.5		13.1	
	4.0		12.1		11.2	
	6.0		11.5		10.7	
Output return loss	0.05		13.8		13.4	dB
	0.8		20.0		21.9	
	2.0		16.8		20.7	
	3.0		16.0		20.1	
	4.0		19.1		22.5	
	6.0		18.6		19.7	
Reverse isolation	2.0		21.4			dB
Output power @ 1dB compression <sup>2</sup>	0.05		19.1		14.8	dBm
	0.8		21.1		17.9	
	2.0		21.5		18.8	
	3.0		22.3		19.5	
	4.0		22.2		19.9	
	6.0		22.8		20.5	
Output IP3	0.05		35.8		31.1	dBm
	0.8		38.0		32.6	
	2.0		40.3		33.4	
	3.0		41.6		34.2	
	4.0		42.2		33.1	
	6.0		42.8		32.4	
Device operating voltage			5.0		3.0	V
Device operating current		72	97	120	60	mA
Device current variation vs voltage			0.035		0.018	mA/mV
Thermal resistance, junction-to-ground lead			32		32	°C/W

1. Measured on Mini-Circuits Die Characterization test board. See Characterization Test Circuit (Fig. 1)

2. Current increases at P1dB

**Absolute Maximum Ratings<sup>3</sup>**

Parameter	Ratings
Operating Temperature (ground lead)	-40°C to 85°C
Operating Current at 5.0V	200 mA
Power Dissipation at 5.0V	1W
Input Power (CW)	+21 dBm (50 to 2000 MHz) +26 dBm (2000 to 4000 MHz)
DC Voltage on RF-OUT & DC-IN	6V

3. Permanent damage may occur if any of these limits are exceeded.  
Electrical maximum ratings are not intended for continuous normal operation.  
Measured in industry standard SOT-89 package.



Characterization Test Circuit

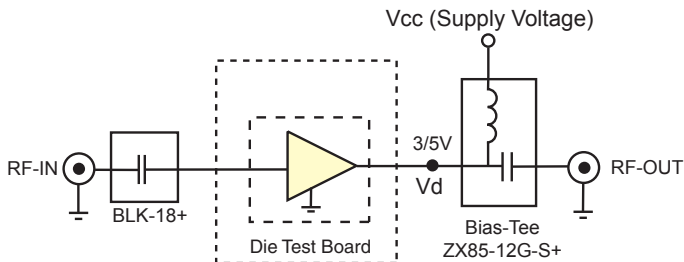

Fig 1. Block Diagram of Test Circuit used for characterization. Gain, Return loss, Output power at 1dB compression (P1 dB) , output IP3 (OIP3) and noise figure measured using Agilent’s N5242A PNA-X microwave network analyzer.

Conditions:

1. Gain and Return loss: Pad= -25dBm
2. Output IP3 (OIP3): Two tones, spaced 1 MHz apart, 5 dBm/tone at output.

Recommended Application Circuit

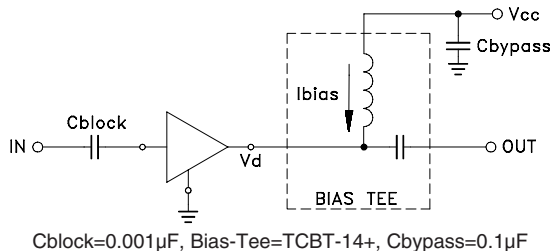

Fig 2a. Simplified

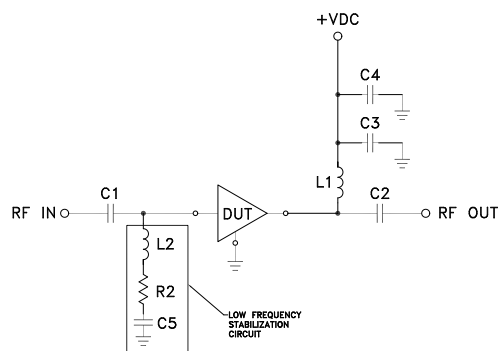

Fig 2b. Unconditionally stable (see note AN-60-064)

SEQ	Manufacturer P/N / Value	Size
A1	PGA-103-D+ in industry standard SOT-89	—
C1, C2	.01 uF	0805
C3	0.33 uF	1206
C4	10 uF	1206
C5	330 pF	0603
L1	TCCH-80+	—
L2	620 nH	.115X.110
R2	150 Ohm	0603

Die Layout

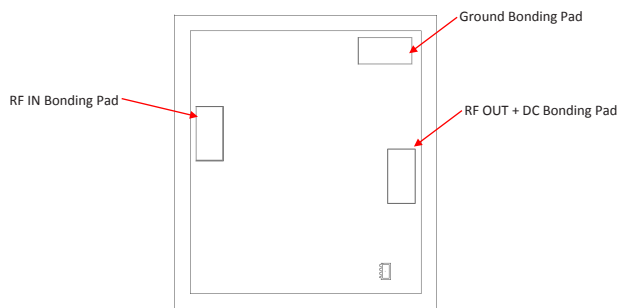

Fig 3. Die Layout

Critical Dimensions

Parameter	Values
Die Thickness, μm	100
Die Width, μm	820
Die Length, μm	731
Bond Pad Size, μm	150 x 75

Bonding Pad Position  
(Dimensions in μm, Typical)

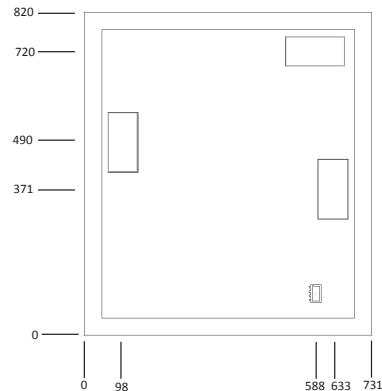

Fig 4. Bonding Pad Positions

# Monolithic E-PHEMT MMIC Amplifier Die

## Assembly and Handling Procedure

- Storage**  
Dice should be stored in a dry nitrogen purged desiccators or equivalent.
- ESD**  
MMIC E-PHEMPT amplifier dice are susceptible to electrostatic and mechanical damage. Die are supplied in antistatic protected material, which should be opened in clean room conditions at an appropriately grounded anti-static workstation. Devices need careful handling using correctly designed collets, vacuum pickup tips or sharp antistatic tweezers to deter ESD damage to dice.
- Die Attach**  
The die mounting surface must be clean and flat. Using conductive silver filled epoxy, recommended epoxies are DieMat DM6030HK-PT/H579 or Ablestik 84-1LMISR4. Apply sufficient epoxy to meet required epoxy bond line thickness, epoxy fillet height and epoxy coverage around total die periphery. Parts shall be cured in a nitrogen filled atmosphere per manufacturer's cure condition. It is recommended to use antistatic die pick up tools only.
- Wire Bonding**  
Bond pad openings in the surface passivation above the bond pads are provided to allow wire bonding to the dice gold bond pads. Thermosonic bonding is used with minimized ultrasonic content. Bond force, time, ultrasonic power and temperature are all critical parameters. Suggested wire is pure gold, 1 mil diameter. Bonds must be made from the bond pads on the die to the package or substrate. All bond wires should be kept as short as low as reasonable to minimize performance degradation due to undesirable series inductance.

## Assembly Diagram

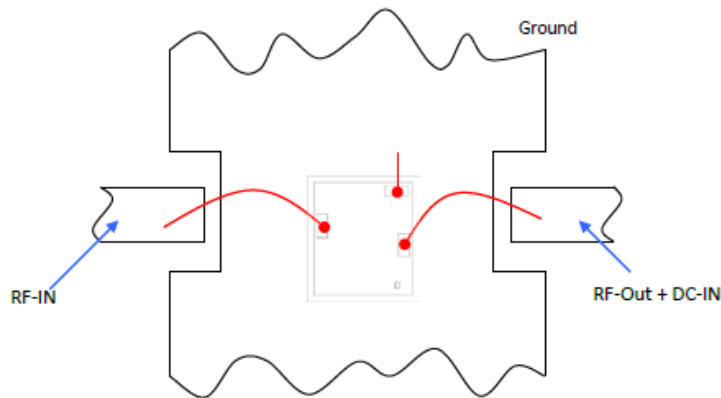

## Recommended Wire Length, Typical

Wire	Wire Length (mm)	Wire Loop Height (mm)
RF-IN, RF-OUT + DC-IN	0.6	0.15
GROUND	0.3	0.15

## RF Reference Plane - No port extension

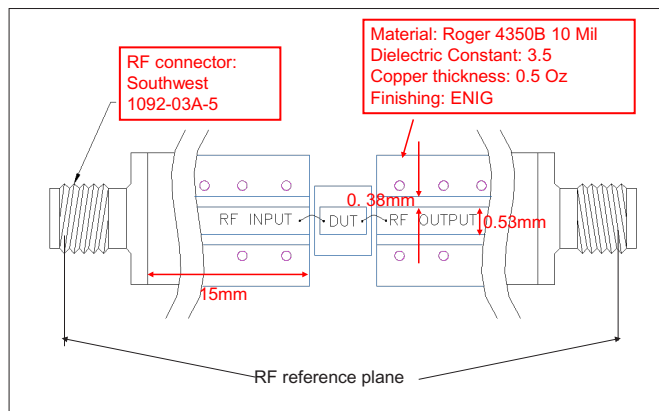

<b>Additional Detailed Technical Information</b> <i>additional information is available on our dash board.</i>	
<b>Performance Data</b>	Data Table
	Swept Graphs
	S-Parameter (S2P Files) Data Set with and without port extension(.zip file)
<b>Case Style</b>	Die
<b>Die Ordering and packaging information</b>	Quantity, Package <span style="float:right">Model No.</span>
	Small, Gel - Pak: 10,50,100 KGD* <span style="float:right">PGA-103-DG+</span> Medium†, Partial wafer: KGD*<5K <span style="float:right">PGA-103-DP+</span> Large†, Full Wafer <span style="float:right">PGA-103-DF+</span>
	†Available upon request contact sales representative
	Refer to <a href="#">AN-60-067</a>
<b>Environmental Ratings</b>	ENV-80

\*Known Good Dice ("KGD") means that the dice in question have been subjected to Mini-Circuits DC test performance criteria and measurement instructions and that the parametric data of such dice fall within a predefined range. While DC testing is not definitive, it does help to provide a higher degree of confidence that dice are capable of meeting typical RF electrical parameters specified by Mini-Circuits.

**ESD Rating\*\***

Human Body Model (HBM): Class 1A (250 to <500V) in accordance with ANSI/ESD STM 5.1 - 2001

Machine Model (MM): Class M1 (25V) in accordance with ANSI/ESD STM5.2-1999

\*\* Tested in industry standard SOT-89 package.



**Attention**  
Observe precautions  
for handling electrostatic  
sensitive devices

**Additional Notes**

- A. Performance and quality attributes and conditions not expressly stated in this specification document are intended to be excluded and do not form a part of this specification document.
- B. Electrical specifications and performance data contained in this specification document are based on Mini-Circuit's applicable established test performance criteria and measurement instructions.
- C. The parts covered by this specification document are subject to Mini-Circuits standard limited warranty and terms and conditions (collectively, "Standard Terms"); Purchasers of this part are entitled to the rights and benefits contained therein. For a full statement of the Standard Terms and the exclusive rights and remedies thereunder, please visit Mini-Circuits' website at [www.minicircuits.com/MCLStore/terms.jsp](http://www.minicircuits.com/MCLStore/terms.jsp)
- D. Mini-Circuits does not warrant the accuracy or completeness of the information, text, graphics and other items contained within this document and same are provided as an accommodation and on an "As is" basis, with all faults.
- E. Purchasers of this part are solely responsible for proper storing, handling, assembly and processing of Known Good Dice (including, without limitation, proper ESD preventative measures, die preparation, die attach, wire bonding and related assembly and test activities), and Mini-Circuits assumes no responsibility therefor or for environmental effects on Known Good Dice.
- F. Mini-Circuits and the Mini-Circuits logo are registered trademarks of Scientific Components Corporation d/b/a Mini-Circuits. All other third-party trademarks are the property of their respective owners. A reference to any third-party trademark does not constitute or imply any endorsement, affiliation, sponsorship, or recommendation by any such third-party of Mini-Circuits or its products.

