

Frequency Synthesizer

KSN-996A-119+

50Ω 956 to 1002 MHz

The Big Deal

- Low phase noise and spurious
- Robust design and construction
- Small size 0.80" x 0.58" x 0.15"



CASE STYLE: DK801

Product Overview

The KSN-996A-119+ is a Frequency Synthesizer, designed to operate from 956 to 1002 MHz for CDMA application. The KSN-996A-119+ is packaged in a metal case (size of 0.80" x 0.58" x 0.15") to shield against unwanted signals and noise.

Key Features

Feature	Advantages
Low phase noise and spurious: <ul style="list-style-type: none">• Phase Noise: -111 dBc/Hz typ. @ 10 kHz offset• Comparison Spurious: -95 dBc typ.• Reference Spurious: -108 dBc typ.	Low phase noise and spurious improve system EVM (Error Vector Magnitude).
Robust design and construction	To enhance the robustness of KSN-996A-119+, each internal component is secured to the substrate with chip bonder, thereby eliminating the risk of tombstoning during subsequent solder reflow operations by the customer.
Small size, 0.80" x 0.58" x 0.15"	The small size enables the KSN-996A-119+ to be used in compact designs.



IF/RF MICROWAVE COMPONENTS • ISO 9001 ISO 14001 AS9100 CERTIFIED RoHS compliant
P.O. Box 350166, Brooklyn, New York 11235-0003 (718) 934-4500 Fax (718) 332-4661



The Design Engineers Search Engine finds the model you need, Instantly • For detailed performance specs & shopping online see



Notes: 1. Performance and quality attributes and conditions not expressly stated in this specification sheet are intended to be excluded and do not form a part of this specification sheet. 2. Electrical specifications and performance data contained herein are based on Mini-Circuit's applicable established test performance criteria and measurement instructions. 3. The parts covered by this specification sheet are subject to Mini-Circuits standard limited warranty and terms and conditions (collectively, "Standard Terms"); Purchasers of this part are entitled to the rights and benefits contained therein. For a full statement of the Standard Terms and the exclusive rights and remedies thereunder, please visit Mini-Circuits' website at www.minicircuits.com/MCLStore/terms.jsp.

50Ω 956 to 1002 MHz



CASE STYLE: DK801
PRICE: \$29.95 ea. QTY (1-9)

+ RoHS compliant in accordance with EU Directive (2002/95/EC)

The +Suffix has been added in order to identify RoHS Compliance. See our web site for RoHS Compliance methodologies and qualifications.

Features

- Integrated VCO + PLL
- Low phase noise and spurious
- Robust design and construction
- Low operating voltage (VCC VCO=+5V, VCC PLL=+5V)
- Small size 0.80" x 0.58" x 0.15"

Applications

- CDMA

General Description

The KSN-996A-119+ is a Frequency Synthesizer, designed to operate from 956 to 1002 MHz for CDMA application. The KSN-996A-119+ is packaged in a metal case (size of 0.80" x 0.58" x 0.15") to shield against unwanted signals and noise. To enhance the robustness of KSN-996A-119+, each internal component is secured to the substrate with chip bonder, thereby eliminating the risk of tombstoning during subsequent solder reflow operations by the customer.

Simplified Schematic

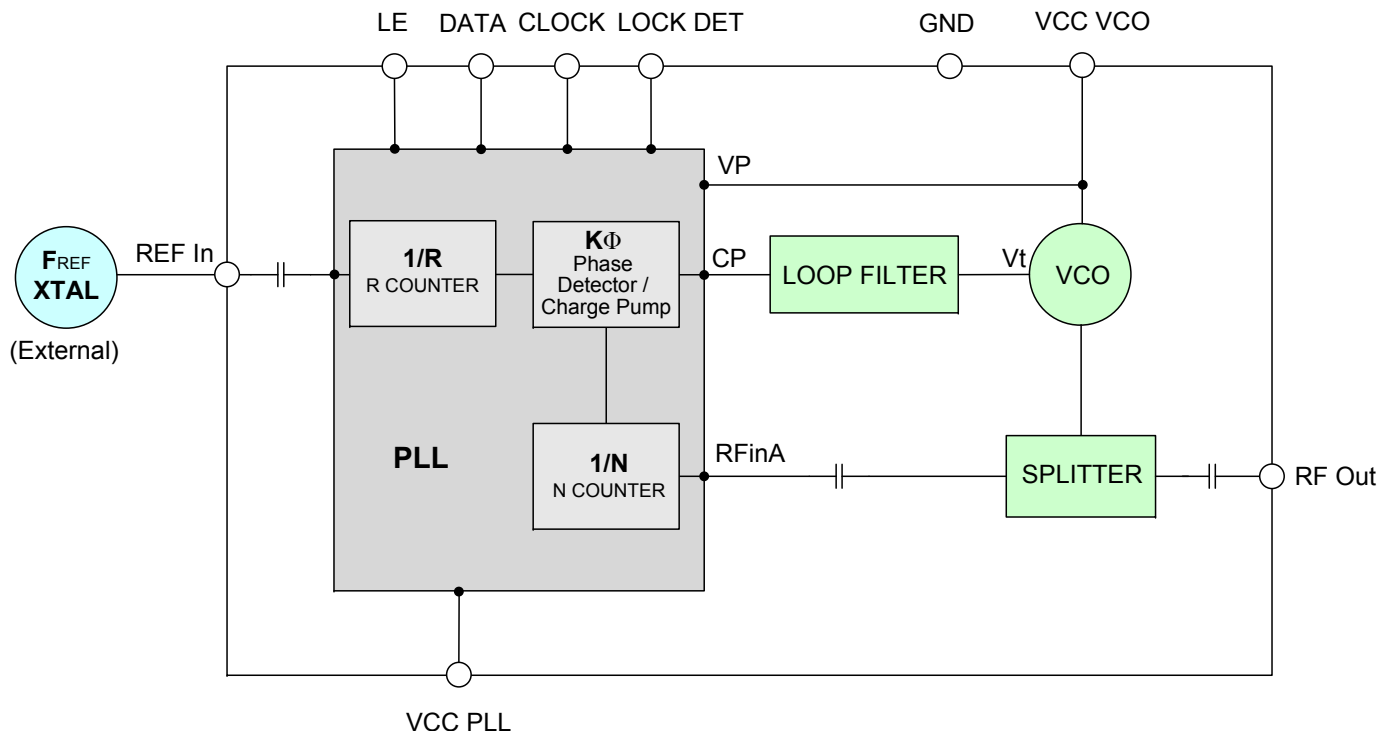

IF/RF MICROWAVE COMPONENTS • ISO 9001 ISO 14001 AS9100 CERTIFIED RoHS compliant
P.O. Box 350166, Brooklyn, New York 11235-0003 (718) 934-4500 Fax (718) 332-4661



The Design Engineers Search Engine finds the model you need, Instantly • For detailed performance specs & shopping online see



Notes: 1. Performance and quality attributes and conditions not expressly stated in this specification sheet are intended to be excluded and do not form a part of this specification sheet. 2. Electrical specifications and performance data contained herein are based on Mini-Circuit's applicable established test performance criteria and measurement instructions. 3. The parts covered by this specification sheet are subject to Mini-Circuits standard limited warranty and terms and conditions (collectively, "Standard Terms"); Purchasers of this part are entitled to the rights and benefits contained therein. For a full statement of the Standard Terms and the exclusive rights and remedies thereunder, please visit Mini-Circuits' website at www.minicircuits.com/MCLStore/terms.jsp.

Electrical Specifications (over operating temperature -40°C to +85°C)

Parameters	Test Conditions	Min.	Typ.	Max.	Units
Frequency Range	-	956	-	1002	MHz
Step Size	-	-	1000	-	kHz
Settling Time	Within ± 1 kHz	-	3	-	mSec
Output Power	-	-2.5	+0.6	+2.5	dBm
SSB Phase Noise	@ 100 Hz offset	-	-90	-	dBc/Hz
	@ 1 kHz offset	-	-90	-80	
	@ 10 kHz offset	-	-111	-104	
	@ 100 kHz offset	-	-137	-132	
	@ 1 MHz offset	-	-138	-124	
Integrated SSB Phase Noise	@100 Hz to 1 MHz	-	-46	-41	dBc
Reference Spurious Suppression	Ref. Freq. 15 MHz	-	-108	-75	
Comparison Spurious Suppression	Step Size 1000 kHz	-	-95	-75	
Non - Harmonic Spurious Suppression	-	-	-90	-	
Harmonic Suppression	-	-	-33	-24	
VCO Supply Voltage	5.00	4.75	5.00	5.25	V
PLL Supply Voltage	5.00	4.75	5.00	5.25	
VCO Supply Current	-	-	34	40	mA
PLL Supply Current	-	-	11	19	
Reference Input (External)	Frequency	15 (sine wave)	-	15	MHz
	Amplitude	1	-	1	V _{P-P}
	Input impedance	-	-	100	KΩ
	Phase Noise @ 1 kHz offset	-	-	-140	dBc/Hz
RF Output port Impedance	-	-	50	-	Ω
Input Logic Level	Input high voltage	-	4.20	-	V
	Input low voltage	-	-	0.95	
Digital Lock Detect	Locked	-	4.35	5.25	
	Unlocked	-	-	0.40	
Frequency Synthesizer PLL	-	ADF4113			
PLL Programming	-	3-wire serial 5V CMOS			
Register Map @ 1002 MHz	F_Register	-	(MSB) 0101111100000010010011 (LSB)		
	N_Register	-	(MSB) 0000000001111000101001 (LSB)		
	R_Register	-	(MSB) 0001000000000000111100 (LSB)		

Absolute Maximum Ratings

Parameters	Ratings
VCO Supply Voltage	6V
PLL Supply Voltage	6V
VCO Supply Voltage to PLL Supply Voltage	-0.3V to +5.5V
Reference Frequency Voltage	-0.3Vmin, VCC PLL +0.3Vmax
Data, Clock, LE Levels	-0.3Vmin, VCC PLL +0.3Vmax
Operating Temperature	-40°C to +85°C
Storage Temperature	-55°C to +100°C

Permanent damage may occur if any of these limits are exceeded



IF/RF MICROWAVE COMPONENTS • ISO 9001 ISO 14001 AS 9100 CERTIFIED RoHS compliant
 P.O. Box 350166, Brooklyn, New York 11235-0003 (718) 934-4500 Fax (718) 332-4661



The Design Engineers Search Engine finds the model you need, Instantly • For detailed performance specs & shopping online see



Notes: 1. Performance and quality attributes and conditions not expressly stated in this specification sheet are intended to be excluded and do not form a part of this specification sheet. 2. Electrical specifications and performance data contained herein are based on Mini-Circuit's applicable established test performance criteria and measurement instructions. 3. The parts covered by this specification sheet are subject to Mini-Circuits standard limited warranty and terms and conditions (collectively, "Standard Terms"); Purchasers of this part are entitled to the rights and benefits contained therein. For a full statement of the Standard Terms and the exclusive rights and remedies thereunder, please visit Mini-Circuits' website at www.minicircuits.com/MCLStore/terms.jsp.

Typical Performance Data

FREQUENCY (MHz)	POWER OUTPUT (dBm)			VCO CURRENT (mA)			PLL CURENT (mA)		
	-45°C	+25°C	+85°C	-45°C	+25°C	+85°C	-45°C	+25°C	+85°C
	956	0.64	0.74	0.71	31.99	33.62	34.59	8.89	11.11
962	0.61	0.70	0.67	32.01	33.63	34.58	8.81	11.05	13.07
966	0.59	0.68	0.65	32.01	33.63	34.59	8.86	11.14	13.11
968	0.58	0.67	0.65	32.00	33.62	34.58	8.87	11.20	13.13
974	0.58	0.66	0.63	31.99	33.61	34.57	8.92	11.10	13.19
980	0.57	0.64	0.61	31.97	33.59	34.55	8.84	11.17	13.10
986	0.57	0.64	0.61	31.94	33.58	34.53	8.90	11.22	13.16
992	0.59	0.65	0.62	31.93	33.55	34.52	8.81	11.27	13.07
996	0.60	0.62	0.63	31.91	33.55	34.51	8.86	11.18	13.13
998	0.61	0.63	0.63	31.91	33.54	34.50	8.88	11.24	13.14
1002	0.61	0.63	0.63	31.91	33.53	34.49	8.94	11.26	13.17

FREQUENCY (MHz)	HARMONICS (dBc)					
	F2			F3		
	-45°C	+25°C	+85°C	-45°C	+25°C	+85°C
956	-29.56	-30.96	-31.85	-50.98	-52.58	-52.97
962	-29.95	-31.33	-32.19	-51.70	-53.01	-52.91
966	-30.72	-32.10	-33.00	-51.81	-52.83	-52.61
968	-31.13	-32.53	-33.45	-51.85	-52.48	-52.27
974	-32.11	-33.59	-34.60	-52.26	-52.41	-51.70
980	-32.36	-33.88	-35.01	-52.58	-52.35	-51.42
986	-32.49	-34.02	-35.18	-53.19	-52.40	-51.30
992	-32.80	-34.38	-35.54	-53.09	-51.91	-51.77
996	-32.94	-34.61	-35.85	-52.17	-51.06	-51.04
998	-33.01	-34.72	-36.00	-51.95	-51.00	-50.52
1002	-33.15	-35.00	-36.38	-52.03	-51.11	-50.63



IF/RF MICROWAVE COMPONENTS • ISO 9001 ISO 14001 AS9100 CERTIFIED RoHS compliant
 P.O. Box 350166, Brooklyn, New York 11235-0003 (718) 934-4500 Fax (718) 332-4661



The Design Engineers Search Engine finds the model you need, Instantly • For detailed performance specs & shopping online see



Notes: 1. Performance and quality attributes and conditions not expressly stated in this specification sheet are intended to be excluded and do not form a part of this specification sheet. 2. Electrical specifications and performance data contained herein are based on Mini-Circuit's applicable established test performance criteria and measurement instructions. 3. The parts covered by this specification sheet are subject to Mini-Circuits standard limited warranty and terms and conditions (collectively, "Standard Terms"); Purchasers of this part are entitled to the rights and benefits contained therein. For a full statement of the Standard Terms and the exclusive rights and remedies thereunder, please visit Mini-Circuits' website at www.minicircuits.com/MCLStore/terms.jsp.

FREQUENCY (MHz)	PHASE NOISE (dBc/Hz) @ OFFSETS				
	+25°C				
	100Hz	1kHz	10kHz	100kHz	1MHz
956	-91.08	-90.67	-111.26	-137.25	-147.83
962	-88.09	-90.24	-111.35	-137.19	-143.63
966	-88.10	-91.55	-111.40	-137.36	-143.18
968	-90.77	-88.33	-110.90	-137.34	-149.31
974	-92.38	-89.51	-110.63	-137.22	-133.44
980	-89.68	-89.27	-110.53	-137.40	-137.45
986	-90.85	-90.11	-110.86	-137.02	-134.07
992	-87.35	-90.75	-110.66	-137.07	-138.30
996	-87.85	-88.41	-110.69	-137.02	-133.63
998	-86.56	-87.82	-110.68	-136.65	-134.71
1002	-87.30	-89.07	-110.51	-136.44	-136.07

FREQUENCY (MHz)	PHASE NOISE (dBc/Hz) @ OFFSETS				
	-45°C				
	100Hz	1kHz	10kHz	100kHz	1MHz
956	-90.27	-91.74	-108.82	-137.47	-132.48
962	-89.62	-91.84	-109.09	-137.59	-133.09
966	-89.07	-92.97	-109.05	-137.60	-129.71
968	-89.65	-91.44	-109.18	-137.41	-130.86
974	-90.09	-92.12	-108.97	-137.21	-135.25
980	-90.85	-91.13	-108.34	-136.81	-131.39
986	-91.09	-91.67	-108.05	-136.51	-133.48
992	-90.53	-91.02	-108.39	-136.07	-133.13
996	-88.51	-89.36	-108.35	-135.78	-134.37
998	-89.43	-88.71	-108.28	-135.48	-137.57
1002	-89.68	-88.83	-108.22	-135.08	-139.01

FREQUENCY (MHz)	PHASE NOISE (dBc/Hz) @ OFFSETS				
	+85°C				
	100Hz	1kHz	10kHz	100kHz	1MHz
956	-87.09	-91.02	-110.07	-136.25	-131.76
962	-88.82	-90.78	-107.71	-136.24	-138.97
966	-86.57	-88.61	-109.51	-136.11	-140.22
968	-87.02	-89.21	-107.14	-136.55	-139.64
974	-87.85	-87.78	-108.78	-136.32	-129.37
980	-88.34	-84.57	-106.79	-136.61	-143.09
986	-85.89	-85.48	-106.94	-136.28	-139.82
992	-84.53	-85.27	-106.55	-136.20	-137.41
996	-87.25	-83.73	-106.94	-136.15	-141.16
998	-87.13	-83.25	-106.77	-135.80	-144.64
1002	-85.64	-83.61	-106.70	-135.61	-138.21



IF/RF MICROWAVE COMPONENTS • ISO 9001 ISO 14001 AS 9100 CERTIFIED RoHS compliant
 P.O. Box 350166, Brooklyn, New York 11235-0003 (718) 934-4500 Fax (718) 332-4661



The Design Engineers Search Engine finds the model you need, Instantly • For detailed performance specs & shopping online see



Notes: 1. Performance and quality attributes and conditions not expressly stated in this specification sheet are intended to be excluded and do not form a part of this specification sheet. 2. Electrical specifications and performance data contained herein are based on Mini-Circuit's applicable established test performance criteria and measurement instructions. 3. The parts covered by this specification sheet are subject to Mini-Circuits standard limited warranty and terms and conditions (collectively, "Standard Terms"); Purchasers of this part are entitled to the rights and benefits contained therein. For a full statement of the Standard Terms and the exclusive rights and remedies thereunder, please visit Mini-Circuits' website at www.minicircuits.com/MCLStore/terms.jsp.

COMPARISON SPURIOUS ORDER	COMPARISON SPURIOUS @Fcarrier 956MHz+(n*Fcomparison) (dBc) note 1			COMPARISON SPURIOUS @Fcarrier 981MHz+(n*Fcomparison) (dBc) note 1			COMPARISON SPURIOUS @Fcarrier 1002MHz+(n*Fcomparison) (dBc) note 1			
	n	-45°C	+25°C	+85°C	-45°C	+25°C	+85°C	-45°C	+25°C	+85°C
	-5	-100.67	-107.87	-106.59	-101.73	-110.91	-109.63	-108.51	-118.00	-108.51
-4	-108.12	-113.72	-104.87	-100.20	-105.38	-105.89	-127.51	-108.14	-127.51	
-3	-100.27	-128.13	-104.26	-97.63	-109.53	-106.10	-101.90	-104.38	-101.90	
-2	-94.40	-105.71	-98.68	-94.44	-104.95	-105.31	-102.62	-97.73	-102.62	
-1	-89.15	-104.76	-88.20	-87.11	-94.90	-97.15	-91.61	-89.60	-91.61	
0 note 2	-	-	-	-	-	-	-	-	-	
+1	-88.11	-103.11	-88.88	-87.24	-94.89	-99.50	-92.45	-90.77	-92.45	
+2	-93.57	-102.97	-100.27	-94.35	-99.71	-115.16	-104.03	-98.81	-104.03	
+3	-99.75	-105.28	-108.00	-97.13	-102.70	-110.92	-101.21	-109.45	-101.21	
+4	-108.35	-104.49	-109.52	-98.98	-103.77	-111.15	-113.03	-109.98	-113.03	
+5	-100.11	-114.83	-113.68	-100.04	-104.49	-116.70	-107.26	-109.70	-107.26	

Note 1: Comparison frequency 1000 kHz
 Note 2: All spurs are referenced to carrier signal (n=0).

REFERENCE SPURIOUS ORDER	REFERENCE SPURIOUS @Fcarrier 956MHz+(n*Freference) (dBc) note 3			REFERENCE SPURIOUS @Fcarrier 981MHz+(n*Freference) (dBc) note 3			REFERENCE SPURIOUS @Fcarrier 1002MHz+(n*Freference) (dBc) note 3			
	n	-45°C	+25°C	+85°C	-45°C	+25°C	+85°C	-45°C	+25°C	+85°C
	-5	-95.57	-105.60	-101.94	-96.42	-106.88	-99.48	-97.50	-107.33	-99.54
-4	-94.90	-107.59	-96.86	-98.68	-109.17	-99.51	-101.94	-107.58	-101.23	
-3	-98.81	-104.89	-112.71	-98.27	-108.33	-111.06	-100.07	-108.95	-106.34	
-2	-104.45	-107.36	-115.64	-100.11	-109.92	-110.88	-103.54	-114.08	-110.34	
-1	-104.10	-114.20	-120.27	-102.53	-116.73	-119.20	-104.74	-117.14	-109.98	
0 note 4	-	-	-	-	-	-	-	-	-	
+1	-110.07	-108.27	-119.07	-105.61	-107.29	-110.98	-119.05	-108.12	-109.28	
+2	-103.64	-120.63	-112.26	-99.86	-125.67	-105.52	-107.63	-111.67	-106.25	
+3	-109.17	-108.66	-110.74	-114.04	-108.53	-106.78	-119.96	-105.92	-108.27	
+4	-92.69	-93.29	-93.33	-97.68	-100.43	-102.46	-97.75	-102.07	-101.11	
+5	-100.71	-102.28	-102.54	-100.95	-103.58	-102.71	-101.53	-102.40	-102.27	

Note 3: Reference frequency 15 MHz
 Note 4: All spurs are referenced to carrier signal (n=0).



IF/RF MICROWAVE COMPONENTS • ISO 9001 ISO 14001 AS9100 CERTIFIED RoHS compliant
 P.O. Box 350166, Brooklyn, New York 11235-0003 (718) 934-4500 Fax (718) 332-4661



The Design Engineers Search Engine finds the model you need, Instantly • For detailed performance specs & shopping online see



Notes: 1. Performance and quality attributes and conditions not expressly stated in this specification sheet are intended to be excluded and do not form a part of this specification sheet. 2. Electrical specifications and performance data contained herein are based on Mini-Circuit's applicable established test performance criteria and measurement instructions. 3. The parts covered by this specification sheet are subject to Mini-Circuits standard limited warranty and terms and conditions (collectively, "Standard Terms"); Purchasers of this part are entitled to the rights and benefits contained therein. For a full statement of the Standard Terms and the exclusive rights and remedies thereunder, please visit Mini-Circuits' website at www.minicircuits.com/MCLStore/terms.jsp.

Typical Performance Curves

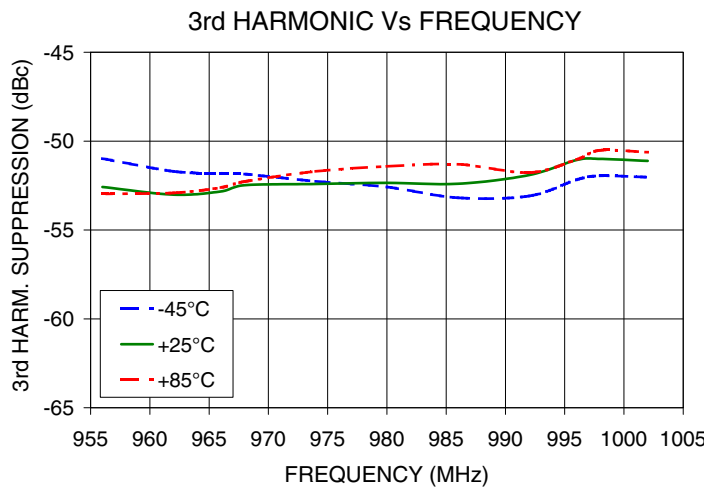
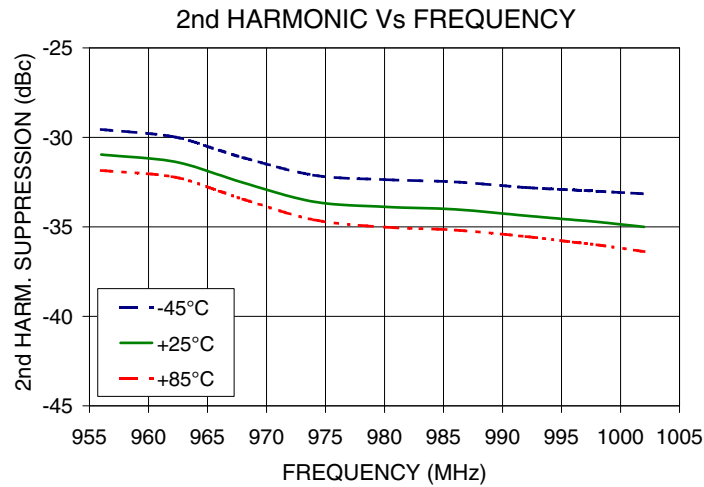
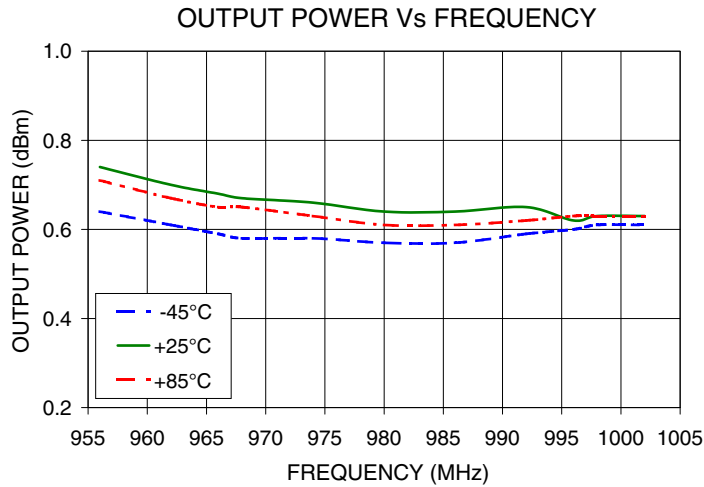

IF/RF MICROWAVE COMPONENTS • ISO 9001 ISO 14001 AS 9100 CERTIFIED RoHS compliant
 P.O. Box 350166, Brooklyn, New York 11235-0003 (718) 934-4500 Fax (718) 332-4661



The Design Engineers Search Engine finds the model you need, Instantly • For detailed performance specs & shopping online see



Notes: 1. Performance and quality attributes and conditions not expressly stated in this specification sheet are intended to be excluded and do not form a part of this specification sheet. 2. Electrical specifications and performance data contained herein are based on Mini-Circuit's applicable established test performance criteria and measurement instructions. 3. The parts covered by this specification sheet are subject to Mini-Circuits standard limited warranty and terms and conditions (collectively, "Standard Terms"); Purchasers of this part are entitled to the rights and benefits contained therein. For a full statement of the Standard Terms and the exclusive rights and remedies thereunder, please visit Mini-Circuits' website at www.minicircuits.com/MCLStore/terms.jsp.

PHASE NOISE @ 100 Hz offset

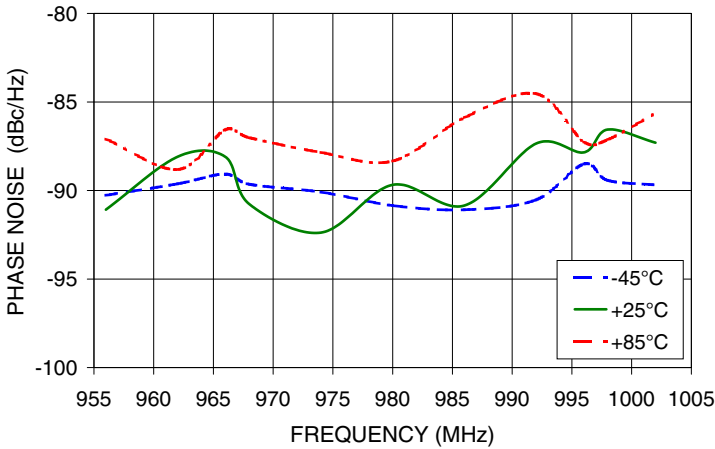

PHASE NOISE @ 1kHz offset

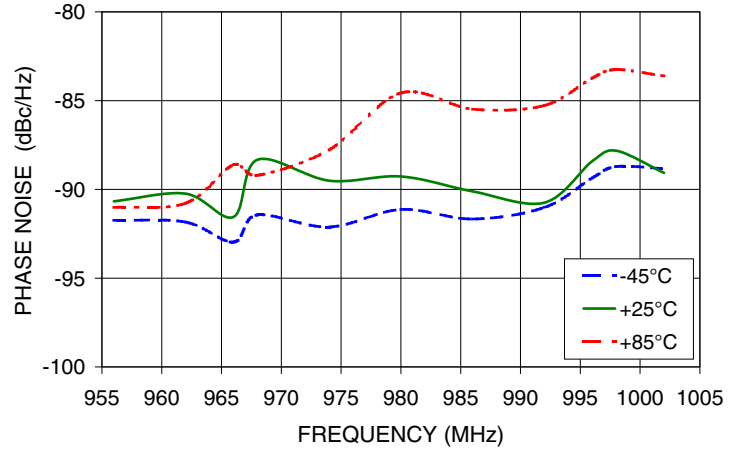

PHASE NOISE @ 10 kHz offset

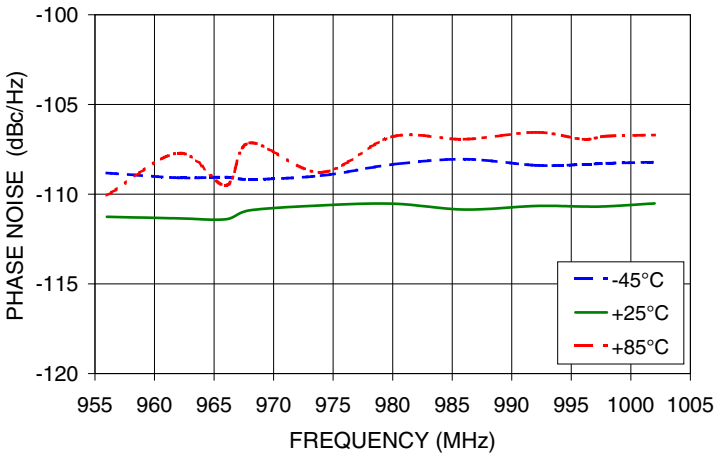

PHASE NOISE @ 100 kHz offset

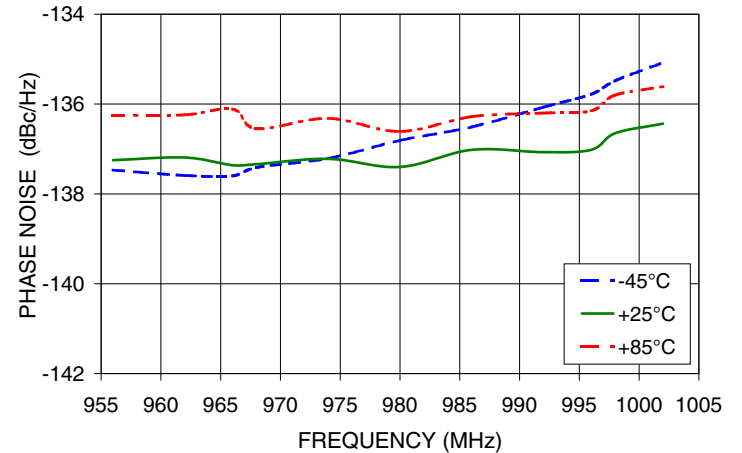

PHASE NOISE @ 1 MHz offset

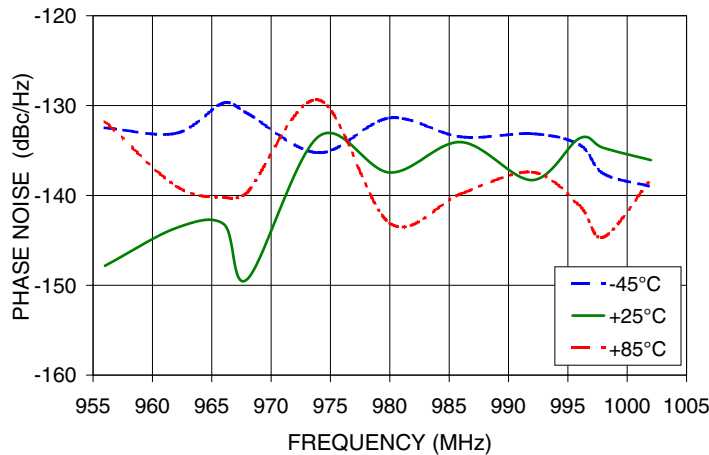

IF/RF MICROWAVE COMPONENTS • ISO 9001 ISO 14001 AS9100 CERTIFIED RoHS compliant
 P.O. Box 350166, Brooklyn, New York 11235-0003 (718) 934-4500 Fax (718) 332-4661



The Design Engineers Search Engine finds the model you need, Instantly • For detailed performance specs & shopping online see



Notes: 1. Performance and quality attributes and conditions not expressly stated in this specification sheet are intended to be excluded and do not form a part of this specification sheet. 2. Electrical specifications and performance data contained herein are based on Mini-Circuit's applicable established test performance criteria and measurement instructions. 3. The parts covered by this specification sheet are subject to Mini-Circuits standard limited warranty and terms and conditions (collectively, "Standard Terms"); Purchasers of this part are entitled to the rights and benefits contained therein. For a full statement of the Standard Terms and the exclusive rights and remedies thereunder, please visit Mini-Circuits' website at www.minicircuits.com/MCLStore/terms.jsp.

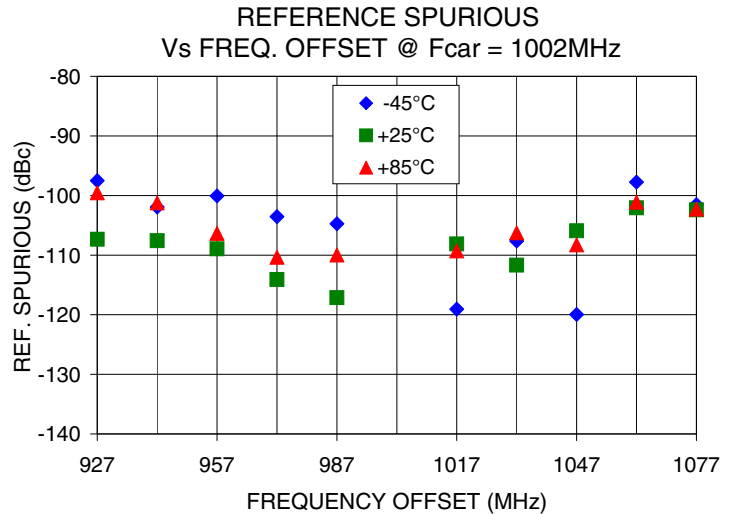
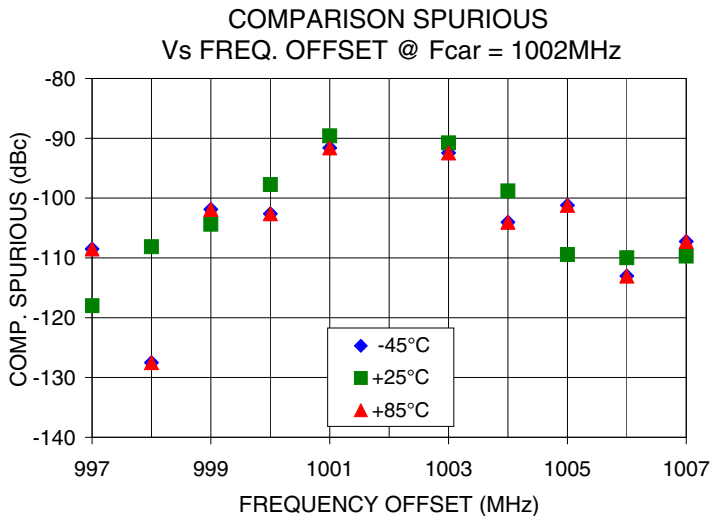
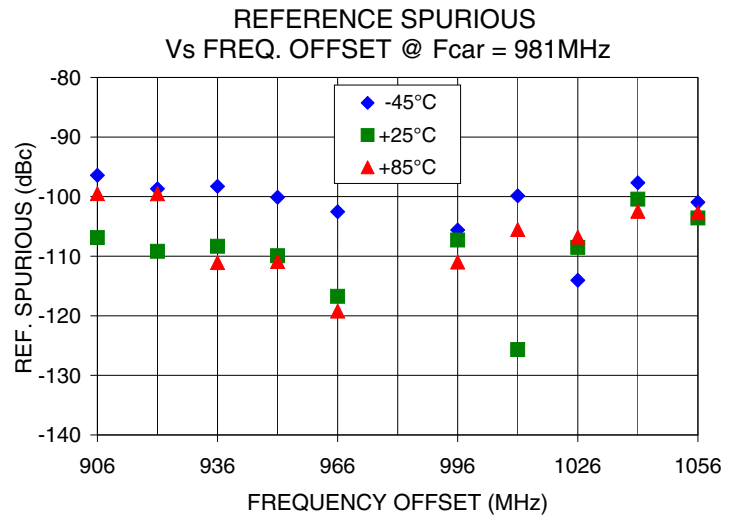
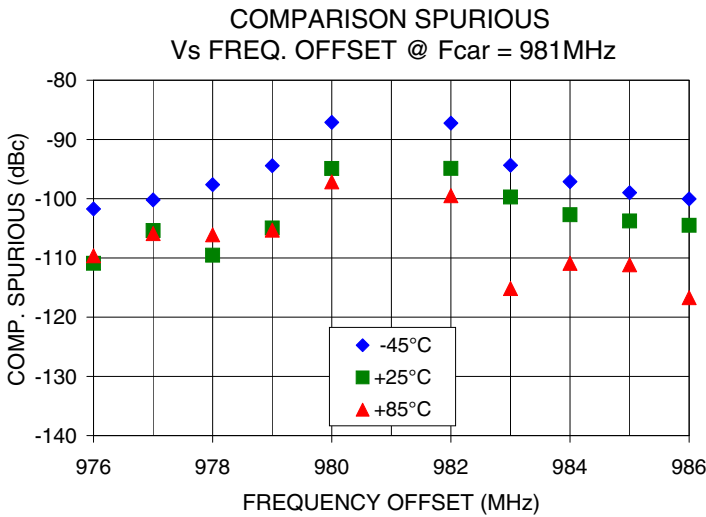
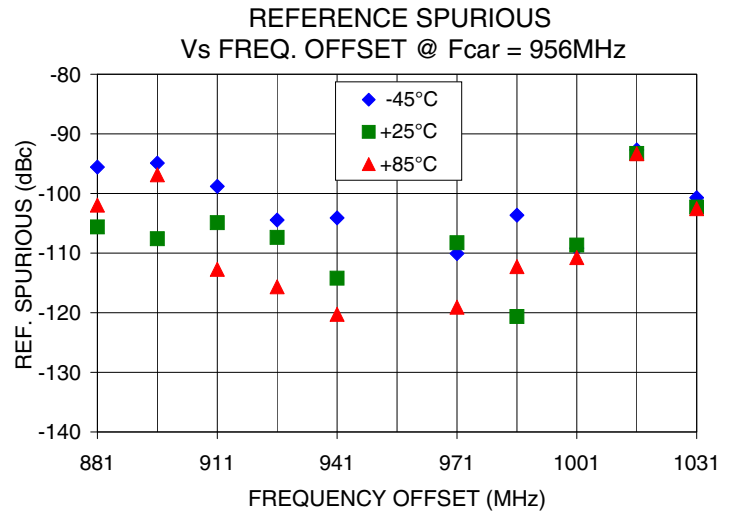
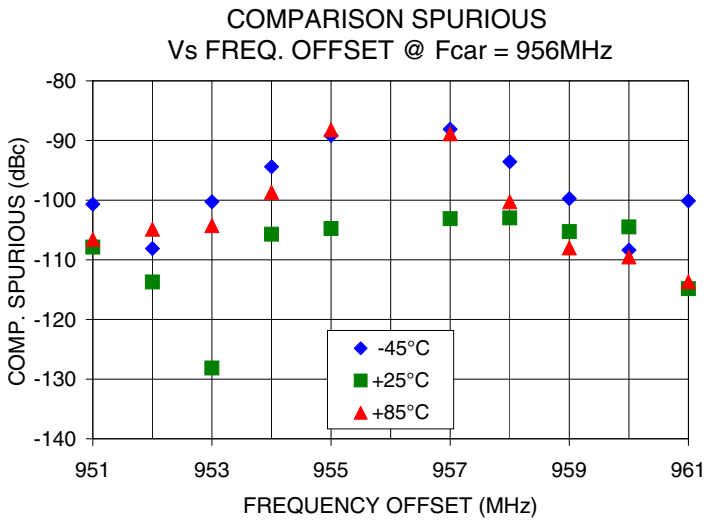

IF/RF MICROWAVE COMPONENTS • ISO 9001 ISO 14001 AS 9100 CERTIFIED RoHS compliant
P.O. Box 350166, Brooklyn, New York 11235-0003 (718) 934-4500 Fax (718) 332-4661



The Design Engineers Search Engine finds the model you need, Instantly • For detailed performance specs & shopping online see



Notes: 1. Performance and quality attributes and conditions not expressly stated in this specification sheet are intended to be excluded and do not form a part of this specification sheet. 2. Electrical specifications and performance data contained herein are based on Mini-Circuits' applicable established test performance criteria and measurement instructions. 3. The parts covered by this specification sheet are subject to Mini-Circuits' standard limited warranty and terms and conditions (collectively, "Standard Terms"); Purchasers of this part are entitled to the rights and benefits contained therein. For a full statement of the Standard Terms and the exclusive rights and remedies thereunder, please visit Mini-Circuits' website at www.minicircuits.com/MCLStore/terms.jsp.

Pin Configuration

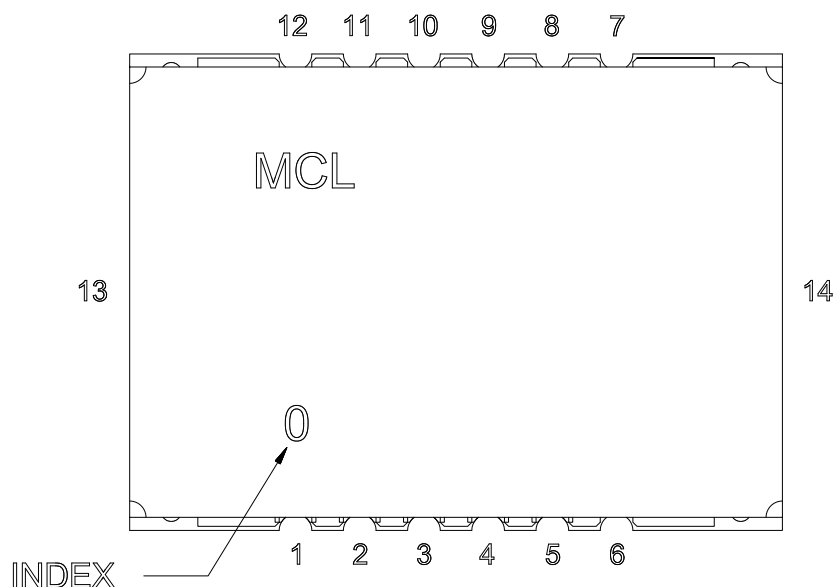

Pin Connection

Pin Number	Function
1	VCC PLL
2	GND
3	REF IN
4	GND
5	VCC VCO
6	GND
7	RF OUT
8	GND
9	LOCK DET
10	CLOCK
11	DATA
12	LE
13	GND
14	GND

Recommended Application Circuit

Note: REF IN and RF OUT ports are internally AC coupled.

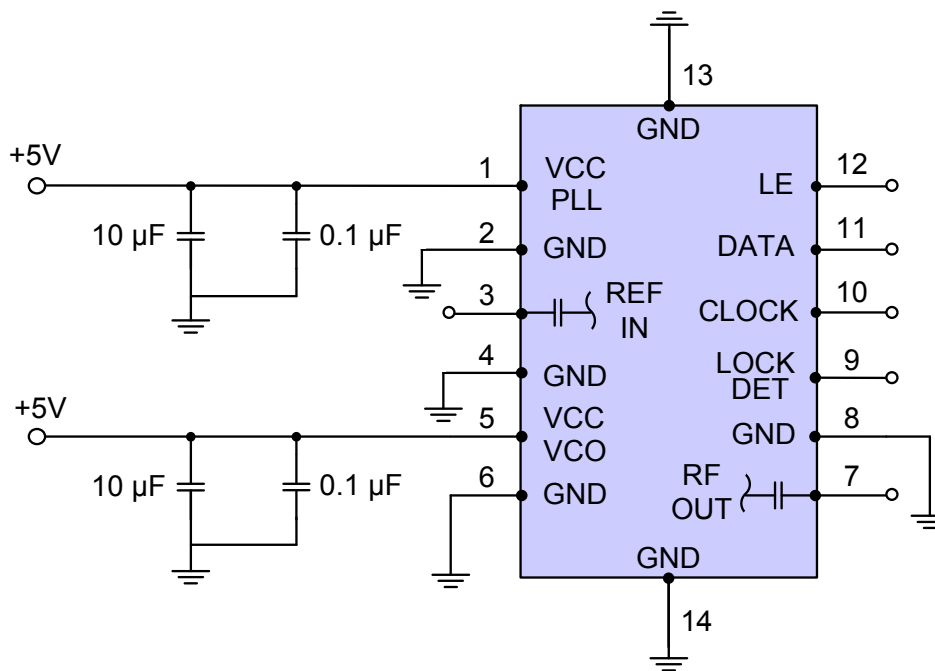

IF/RF MICROWAVE COMPONENTS • ISO 9001 ISO 14001 AS9100 CERTIFIED RoHS compliant
 P.O. Box 350166, Brooklyn, New York 11235-0003 (718) 934-4500 Fax (718) 332-4661



The Design Engineers Search Engine finds the model you need, Instantly • For detailed performance specs & shopping online see



Notes: 1. Performance and quality attributes and conditions not expressly stated in this specification sheet are intended to be excluded and do not form a part of this specification sheet. 2. Electrical specifications and performance data contained herein are based on Mini-Circuit's applicable established test performance criteria and measurement instructions. 3. The parts covered by this specification sheet are subject to Mini-Circuits standard limited warranty and terms and conditions (collectively, "Standard Terms"); Purchasers of this part are entitled to the rights and benefits contained therein. For a full statement of the Standard Terms and the exclusive rights and remedies thereunder, please visit Mini-Circuits' website at www.minicircuits.com/MCLStore/terms.jsp.

Device Marking

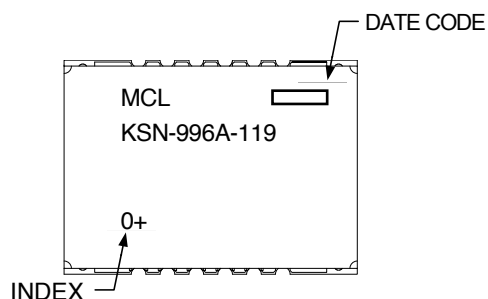

Additional Detailed Technical Information

Additional information is available on our web site. To access this information enter the model number on our web site home page.

Case Style: DK801

Tape & Reel: TR-F28

Suggested Layout for PCB Design: PL-249

Evaluation Board: TB-567+

Environment Ratings: ENV03T2



IF/RF MICROWAVE COMPONENTS • ISO 9001 ISO 14001 AS 9100 CERTIFIED RoHS compliant
P.O. Box 350166, Brooklyn, New York 11235-0003 (718) 934-4500 Fax (718) 332-4661



Patent Pending

The Design Engineers Search Engine finds the model you need, Instantly • For detailed performance specs & shopping online see



Notes: 1. Performance and quality attributes and conditions not expressly stated in this specification sheet are intended to be excluded and do not form a part of this specification sheet. 2. Electrical specifications and performance data contained herein are based on Mini-Circuit's applicable established test performance criteria and measurement instructions. 3. The parts covered by this specification sheet are subject to Mini-Circuits standard limited warranty and terms and conditions (collectively, "Standard Terms"); Purchasers of this part are entitled to the rights and benefits contained therein. For a full statement of the Standard Terms and the exclusive rights and remedies thereunder, please visit Mini-Circuits' website at www.minicircuits.com/MCLStore/terms.jsp.