

Frequency Synthesizer

KSN-900A-119+

50Ω 840 to 900 MHz

The Big Deal

- Low phase noise and spurious
- Robust design and construction
- Small size 0.80" x 0.58" x 0.15"



CASE STYLE: DK1042

Product Overview

The KSN-900A-119+ is a Frequency Synthesizer, designed to operate from 840 to 900 MHz for WCDMA base station application. The KSN-900A-119+ is packaged in a metal case (size of 0.80" x 0.58" x 0.15") to shield against unwanted signals and noise.

Key Features

Feature	Advantages
Low phase noise and spurious: <ul style="list-style-type: none">• Phase Noise: -90 dBc/Hz typ. @ 10 kHz offset• Comparison Spurious: -90 dBc typ.• Reference Spurious: -105 dBc typ.	Low phase noise and spurious improve system EVM (Error Vector Magnitude).
Robust design and construction	To enhance the robustness of KSN-900A-119+, each internal component is secured to the substrate with chip bonder, thereby eliminating the risk of tombstoning during subsequent solder reflow operations by the customer.
Small size, 0.80" x 0.58" x 0.15"	The small size enables the KSN-900A-119+ to be used in compact designs.



IF/RF MICROWAVE COMPONENTS • ISO 9001 ISO 14001 AS9100 CERTIFIED RoHS compliant
P.O. Box 350166, Brooklyn, New York 11235-0003 (718) 934-4500 Fax (718) 332-4661



The Design Engineers Search Engine finds the model you need, Instantly • For detailed performance specs & shopping online see minicircuits.com

Notes: 1. Performance and quality attributes and conditions not expressly stated in this specification sheet are intended to be excluded and do not form a part of this specification sheet. 2. Electrical specifications and performance data contained herein are based on Mini-Circuit's applicable established test performance criteria and measurement instructions. 3. The parts covered by this specification sheet are subject to Mini-Circuits standard limited warranty and terms and conditions (collectively, "Standard Terms"); Purchasers of this part are entitled to the rights and benefits contained therein. For a full statement of the Standard Terms and the exclusive rights and remedies thereunder, please visit Mini-Circuits' website at www.minicircuits.com/MCLStore/terms.jsp.

Frequency Synthesizer

KSN-900A-119+

50Ω 840 to 900 MHz

Features

- Integrated VCO + PLL
- Low phase noise and spurious
- Robust design and construction
- Low operating voltage (VCC VCO=+5V, VCC PLL=+5V)
- Small size 0.80" x 0.58" x 0.15"



CASE STYLE: DK1042
PRICE: \$29.95 ea. QTY (1-9)

+ RoHS compliant in accordance with EU Directive (2002/95/EC)

The +Suffix has been added in order to identify RoHS Compliance. See our web site for RoHS Compliance methodologies and qualifications.

Applications

- WCDMA base station

General Description

The KSN-900A-119+ is a Frequency Synthesizer, designed to operate from 840 to 900 MHz for WCDMA base station application. The KSN-900A-119+ is packaged in a metal case (size of 0.80" x 0.58" x 0.15") to shield against unwanted signals and noise. To enhance the robustness of KSN-900A-119+, each internal component is secured to the substrate with chip bonder, thereby eliminating the risk of tombstoning during subsequent solder reflow operations by the customer.

Simplified Schematic

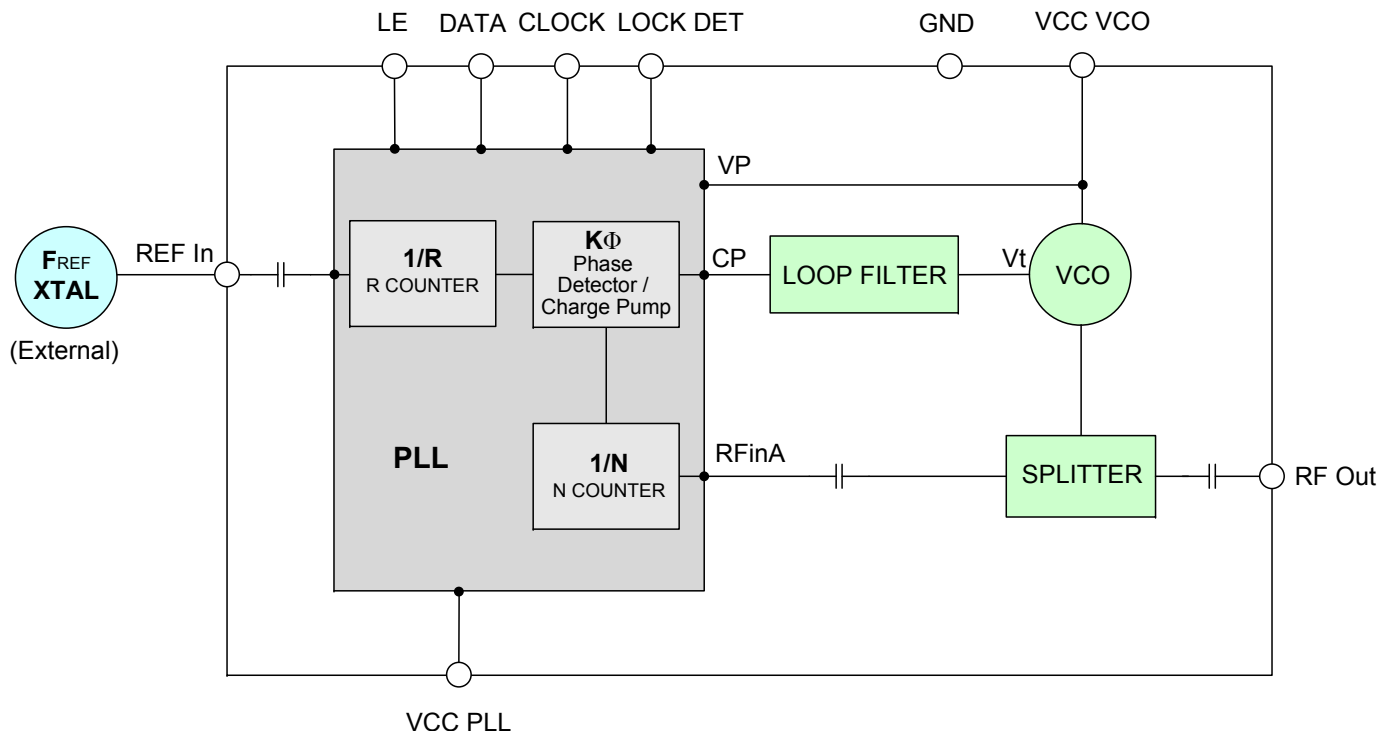

IF/RF MICROWAVE COMPONENTS • ISO 9001 ISO 14001 AS9100 CERTIFIED RoHS compliant
P.O. Box 350166, Brooklyn, New York 11235-0003 (718) 934-4500 Fax (718) 332-4661



The Design Engineers Search Engine finds the model you need, Instantly • For detailed performance specs & shopping online see minicircuits.com

Notes: 1. Performance and quality attributes and conditions not expressly stated in this specification sheet are intended to be excluded and do not form a part of this specification sheet. 2. Electrical specifications and performance data contained herein are based on Mini-Circuit's applicable established test performance criteria and measurement instructions. 3. The parts covered by this specification sheet are subject to Mini-Circuits standard limited warranty and terms and conditions (collectively, "Standard Terms"); Purchasers of this part are entitled to the rights and benefits contained therein. For a full statement of the Standard Terms and the exclusive rights and remedies thereunder, please visit Mini-Circuits' website at www.minicircuits.com/MCLStore/terms.jsp.

Electrical Specifications (over operating temperature -40°C to +85°C)

Parameters	Test Conditions	Min.	Typ.	Max.	Units	
Frequency Range	-	840	-	900	MHz	
Step Size	-	-	100	-	kHz	
Settling Time	Within ± 1 kHz	-	1.1	-	mSec	
Output Power	-	-1.0	+2.2	+4.5	dBm	
SSB Phase Noise	@ 100 Hz offset	-	-83	-	dBc/Hz	
	@ 1 kHz offset	-	-84	-77		
	@ 10 kHz offset	-	-90	-85		
	@ 100 kHz offset	-	-124	-117		
	@ 1 MHz offset	-	-148	-142		
Integrated SSB Phase Noise	@ 50Hz - 5MHz	-	-41	-	dBc	
Reference Spurious Suppression	Ref. Freq. 10 MHz	-	-105	-85	dBc	
Comparison Spurious Suppression	Step Size 100 kHz	-	-90	-70		
Non - Harmonic Spurious Suppression	-	-	-90	-		
Harmonic Suppression	-	-	-30	-20		
VCO Supply Voltage	5.00	+4.85	+5.00	+5.15	V	
PLL Supply Voltage	5.00	+4.85	+5.00	+5.15		
VCO Supply Current	-	-	16	23	mA	
PLL Supply Current	-	-	8	14		
Reference Input (External)	Frequency	10 (square wave)	-	10	-	MHz
	Amplitude	1.0	0.8	1.0	1.2	V _{P-P}
	Input impedance	-	-	100	-	KΩ
	Phase Noise @ 1 kHz offset	-	-	-145	-	dBc/Hz
RF Output port Impedance	-	-	50	-	Ω	
Input Logic Level	Input high voltage	-	4.10	-	-	V
	Input low voltage	-	-	-	0.95	V
Digital Lock Detect	Locked	-	4.35	-	5.50	V
	Unlocked	-	-	-	0.40	V
Frequency Synthesizer PLL	-	ADF4118				
PLL Programming	-	3-wire serial 4.9V CMOS				
Register Map @ 900 MHz	F_Register	-	(MSB) 00000000000010010010 (LSB)			
	N_Register	-	(MSB) 100001000110010100001 (LSB)			
	R_Register	-	(MSB) 100000000000110010000 (LSB)			

Absolute Maximum Ratings

Parameters	Ratings
VCO Supply Voltage	6V
PLL Supply Voltage	6V
VCO Supply Voltage to PLL Supply Voltage	N.A.
Reference Frequency Voltage	-0.3Vmin, +5.05Vmax
Data, Clock, LE Levels	-0.3Vmin, +5.05Vmax
Operating Temperature	-40°C to +85°C
Storage Temperature	-55°C to +100°C

Permanent damage may occur if any of these limits are exceeded



IF/RF MICROWAVE COMPONENTS • ISO 9001 ISO 14001 AS9100 CERTIFIED RoHS compliant
 P.O. Box 350166, Brooklyn, New York 11235-0003 (718) 934-4500 Fax (718) 332-4661

The Design Engineers Search Engine finds the model you need, Instantly • For detailed performance specs & shopping online see minicircuits.com

Notes: 1. Performance and quality attributes and conditions not expressly stated in this specification sheet are intended to be excluded and do not form a part of this specification sheet. 2. Electrical specifications and performance data contained herein are based on Mini-Circuit's applicable established test performance criteria and measurement instructions. 3. The parts covered by this specification sheet are subject to Mini-Circuits standard limited warranty and terms and conditions (collectively, "Standard Terms"); Purchasers of this part are entitled to the rights and benefits contained therein. For a full statement of the Standard Terms and the exclusive rights and remedies thereunder, please visit Mini-Circuits' website at www.minicircuits.com/MCLStore/terms.jsp.

Typical Performance Data

FREQUENCY (MHz)	POWER OUTPUT (dBm)			VCO CURRENT (mA)			PLL CURENT (mA)		
	-45°C	+25°C	+85°C	-45°C	+25°C	+85°C	-45°C	+25°C	+85°C
	840	2.36	2.40	2.31	15.28	16.19	16.83	6.71	7.86
846	2.14	2.27	2.24	15.29	16.22	16.87	6.72	7.86	9.04
854	1.94	2.14	2.17	15.33	16.27	16.94	6.75	7.88	9.07
862	1.82	2.08	2.15	15.39	16.34	17.01	6.73	7.87	9.06
870	1.79	2.07	2.18	15.46	16.41	17.09	6.75	7.89	9.08
878	1.83	2.11	2.26	15.53	16.49	17.14	6.75	7.88	9.07
886	1.91	2.19	2.38	15.60	16.55	17.18	6.76	7.90	9.09
894	1.99	2.32	2.49	15.64	16.57	17.18	6.75	7.89	9.08
900	2.06	2.37	2.51	15.65	16.54	17.17	6.75	7.89	9.08

FREQUENCY (MHz)	HARMONICS (dBc)					
	F2			F3		
	-45°C	+25°C	+85°C	-45°C	+25°C	+85°C
840	-26.19	-27.73	-29.60	-35.37	-37.88	-40.97
846	-27.34	-28.67	-30.41	-36.22	-38.94	-42.03
854	-28.23	-29.40	-31.01	-37.31	-39.75	-42.79
862	-29.04	-30.04	-31.51	-38.37	-41.22	-44.34
870	-29.91	-30.80	-32.23	-40.36	-42.37	-45.77
878	-30.51	-31.37	-32.78	-41.12	-43.71	-47.57
886	-31.26	-32.08	-33.32	-42.94	-46.22	-51.20
894	-31.92	-32.52	-33.61	-45.21	-49.38	-52.96
900	-32.18	-32.72	-33.87	-48.73	-52.55	-53.24



IF/RF MICROWAVE COMPONENTS • ISO 9001 ISO 14001 AS9100 CERTIFIED RoHS compliant
 P.O. Box 350166, Brooklyn, New York 11235-0003 (718) 934-4500 Fax (718) 332-4661



The Design Engineers Search Engine finds the model you need, Instantly • For detailed performance specs & shopping online see



Notes: 1. Performance and quality attributes and conditions not expressly stated in this specification sheet are intended to be excluded and do not form a part of this specification sheet. 2. Electrical specifications and performance data contained herein are based on Mini-Circuit's applicable established test performance criteria and measurement instructions. 3. The parts covered by this specification sheet are subject to Mini-Circuits standard limited warranty and terms and conditions (collectively, "Standard Terms"); Purchasers of this part are entitled to the rights and benefits contained therein. For a full statement of the Standard Terms and the exclusive rights and remedies thereunder, please visit Mini-Circuits' website at www.minicircuits.com/MCLStore/terms.jsp.

FREQUENCY (MHz)	PHASE NOISE (dBc/Hz) @ OFFSETS				
	+25°C				
	100Hz	1kHz	10kHz	100kHz	1MHz
840	-85.10	-82.82	-90.99	-124.63	-149.30
846	-85.08	-83.81	-90.98	-123.74	-150.54
854	-83.76	-83.42	-90.94	-125.28	-149.08
862	-84.30	-82.44	-90.72	-124.14	-150.54
870	-82.86	-83.20	-89.92	-124.46	-149.52
878	-83.39	-82.14	-90.47	-124.40	-150.04
886	-84.42	-83.75	-91.20	-123.54	-147.94
894	-83.18	-82.07	-91.16	-122.54	-146.92
900	-83.44	-83.46	-90.94	-123.51	-147.21

FREQUENCY (MHz)	PHASE NOISE (dBc/Hz) @ OFFSETS				
	-45°C				
	100Hz	1kHz	10kHz	100kHz	1MHz
840	-81.77	-82.79	-90.40	-124.95	-150.35
846	-84.11	-83.34	-90.47	-125.40	-151.33
854	-83.42	-82.16	-90.28	-125.60	-152.10
862	-83.16	-82.11	-90.84	-125.99	-152.95
870	-82.85	-84.28	-89.32	-126.28	-152.96
878	-84.06	-81.60	-90.46	-125.14	-152.74
886	-83.48	-82.80	-91.04	-125.28	-151.96
894	-82.84	-82.76	-90.79	-124.98	-151.17
900	-82.22	-81.69	-91.35	-125.28	-150.42

FREQUENCY (MHz)	PHASE NOISE (dBc/Hz) @ OFFSETS				
	+85°C				
	100Hz	1kHz	10kHz	100kHz	1MHz
840	-81.27	-83.17	-90.63	-123.85	-149.03
846	-83.87	-82.65	-91.32	-123.94	-148.44
854	-86.23	-80.88	-90.42	-123.01	-148.45
862	-82.27	-82.78	-88.91	-122.64	-148.19
870	-85.14	-82.16	-89.41	-123.42	-147.58
878	-83.06	-81.00	-90.37	-123.17	-147.23
886	-82.18	-82.98	-90.72	-120.62	-146.23
894	-82.24	-80.19	-90.72	-122.37	-145.42
900	-81.88	-80.27	-90.24	-122.18	-144.88



IF/RF MICROWAVE COMPONENTS • ISO 9001 ISO 14001 AS9100 CERTIFIED RoHS compliant
 P.O. Box 350166, Brooklyn, New York 11235-0003 (718) 934-4500 Fax (718) 332-4661



The Design Engineers Search Engine finds the model you need, Instantly • For detailed performance specs & shopping online see



Notes: 1. Performance and quality attributes and conditions not expressly stated in this specification sheet are intended to be excluded and do not form a part of this specification sheet. 2. Electrical specifications and performance data contained herein are based on Mini-Circuit's applicable established test performance criteria and measurement instructions. 3. The parts covered by this specification sheet are subject to Mini-Circuits standard limited warranty and terms and conditions (collectively, "Standard Terms"); Purchasers of this part are entitled to the rights and benefits contained therein. For a full statement of the Standard Terms and the exclusive rights and remedies thereunder, please visit Mini-Circuits' website at www.minicircuits.com/MCLStore/terms.jsp.

COMPARISON SPURIOUS ORDER	COMPARISON SPURIOUS @Fcarrier 840MHz+(n*Fcomparison) (dBc) note 1			COMPARISON SPURIOUS @Fcarrier 870MHz+(n*Fcomparison) (dBc) note 1			COMPARISON SPURIOUS @Fcarrier 900MHz+(n*Fcomparison) (dBc) note 1			
	n	-45°C	+25°C	+85°C	-45°C	+25°C	+85°C	-45°C	+25°C	+85°C
	-5	-102.65	-104.64	-112.57	-108.04	-103.89	-104.36	-111.18	-110.02	-100.99
-4	-102.27	-103.18	-110.00	-106.00	-100.28	-102.01	-108.00	-108.01	-98.51	
-3	-100.18	-102.02	-109.87	-102.25	-95.48	-98.40	-104.11	-106.18	-95.34	
-2	-94.20	-98.54	-110.10	-98.30	-91.10	-95.22	-95.92	-102.35	-91.54	
-1	-86.09	-91.12	-95.65	-83.17	-84.56	-87.12	-79.60	-96.19	-81.84	
0 note 2	-	-	-	-	-	-	-	-	-	
+1	-85.22	-90.71	-96.43	-83.12	-85.46	-87.28	-79.93	-97.65	-81.67	
+2	-93.38	-98.58	-110.02	-98.24	-91.07	-94.52	-95.96	-103.91	-90.85	
+3	-99.63	-103.31	-110.67	-104.23	-95.91	-97.15	-103.07	-106.82	-95.88	
+4	-101.49	-103.08	-114.12	-105.69	-98.93	-100.83	-107.94	-108.10	-99.45	
+5	-101.22	-104.82	-111.93	-111.35	-101.75	-103.55	-109.16	-113.28	-100.63	

Note 1: Comparison frequency 100 kHz

Note 2: All spurs are referenced to carrier signal (n=0).

REFERENCE SPURIOUS ORDER	REFERENCE SPURIOUS @Fcarrier 840MHz+(n*Freference) (dBc) note 3			REFERENCE SPURIOUS @Fcarrier 870MHz+(n*Freference) (dBc) note 3			REFERENCE SPURIOUS @Fcarrier 900MHz+(n*Freference) (dBc) note 3			
	n	-45°C	+25°C	+85°C	-45°C	+25°C	+85°C	-45°C	+25°C	+85°C
	-5	-116.06	-113.65	-112.37	-120.32	-124.84	-122.25	-109.41	-114.24	-117.40
-4	-116.25	-125.85	-119.60	-122.43	-115.81	-120.67	-126.35	-131.05	-122.97	
-3	-109.21	-112.97	-114.76	-110.59	-115.49	-114.17	-108.07	-109.75	-110.58	
-2	-111.62	-125.72	-120.56	-110.87	-113.71	-119.07	-127.77	-129.05	-118.23	
-1	-103.41	-107.04	-113.94	-115.02	-114.78	-113.28	-101.95	-108.49	-110.26	
0 note 4	-	-	-	-	-	-	-	-	-	
+1	-99.95	-102.55	-104.63	-101.45	-104.50	-105.79	-100.01	-101.67	-103.16	
+2	-124.19	-128.32	-122.38	-110.76	-111.70	-110.30	-119.09	-123.02	-121.34	
+3	-106.79	-108.52	-109.92	-116.14	-116.57	-118.16	-117.39	-115.00	-115.71	
+4	-122.71	-128.26	-118.34	-114.14	-115.48	-113.75	-120.77	-123.38	-122.61	
+5	-110.50	-111.94	-111.45	-125.92	-120.91	-120.44	-115.79	-115.04	-115.60	

Note 3: Reference frequency 10 MHz

Note 4: All spurs are referenced to carrier signal (n=0).



IF/RF MICROWAVE COMPONENTS • ISO 9001 ISO 14001 AS9100 CERTIFIED RoHS compliant
 P.O. Box 350166, Brooklyn, New York 11235-0003 (718) 934-4500 Fax (718) 332-4661



The Design Engineers Search Engine finds the model you need, Instantly • For detailed performance specs & shopping online see



Notes: 1. Performance and quality attributes and conditions not expressly stated in this specification sheet are intended to be excluded and do not form a part of this specification sheet. 2. Electrical specifications and performance data contained herein are based on Mini-Circuit's applicable established test performance criteria and measurement instructions. 3. The parts covered by this specification sheet are subject to Mini-Circuits standard limited warranty and terms and conditions (collectively, "Standard Terms"); Purchasers of this part are entitled to the rights and benefits contained therein. For a full statement of the Standard Terms and the exclusive rights and remedies thereunder, please visit Mini-Circuits' website at www.minicircuits.com/MCLStore/terms.jsp.

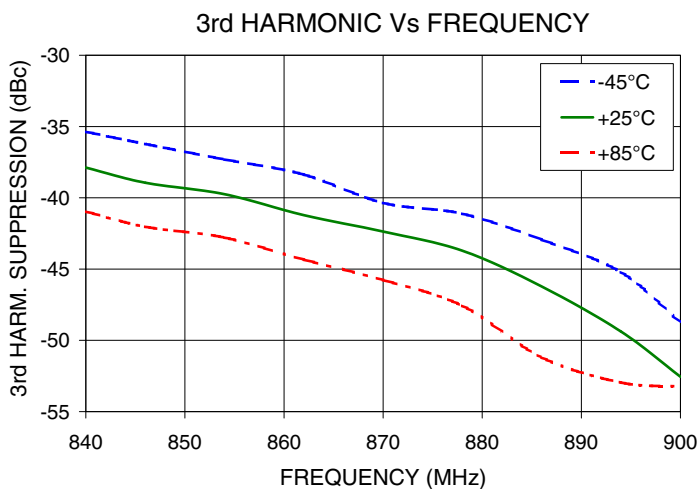
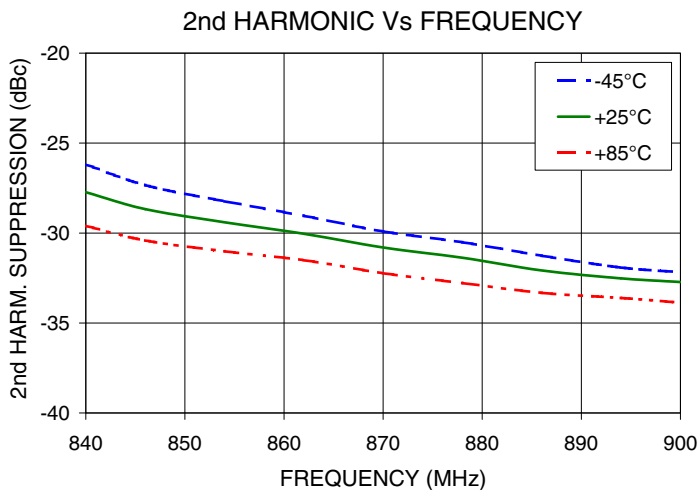
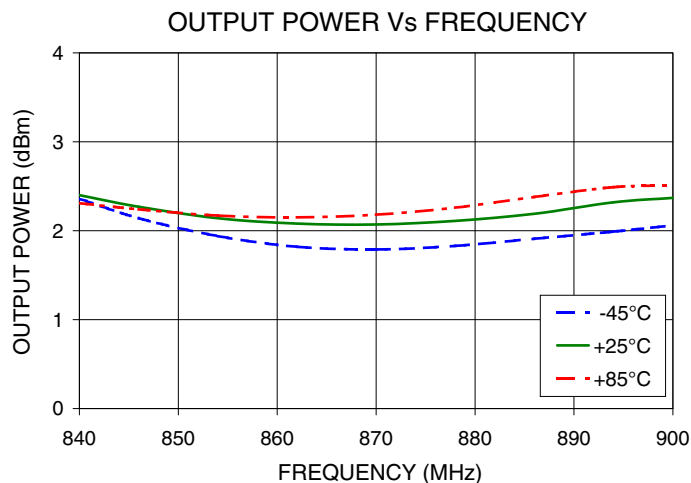

IF/RF MICROWAVE COMPONENTS • ISO 9001 ISO 14001 AS9100 CERTIFIED RoHS compliant
 P.O. Box 350166, Brooklyn, New York 11235-0003 (718) 934-4500 Fax (718) 332-4661



The Design Engineers Search Engine finds the model you need, Instantly • For detailed performance specs & shopping online see



Notes: 1. Performance and quality attributes and conditions not expressly stated in this specification sheet are intended to be excluded and do not form a part of this specification sheet. 2. Electrical specifications and performance data contained herein are based on Mini-Circuit's applicable established test performance criteria and measurement instructions. 3. The parts covered by this specification sheet are subject to Mini-Circuits standard limited warranty and terms and conditions (collectively, "Standard Terms"); Purchasers of this part are entitled to the rights and benefits contained therein. For a full statement of the Standard Terms and the exclusive rights and remedies thereunder, please visit Mini-Circuits' website at www.minicircuits.com/MCLStore/terms.jsp.

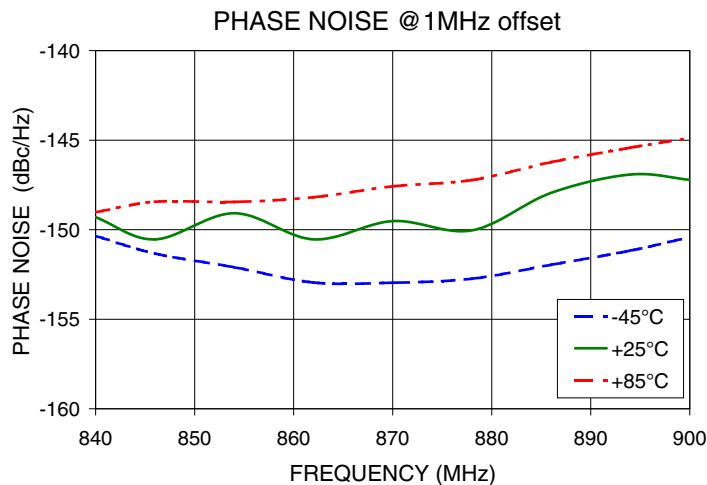
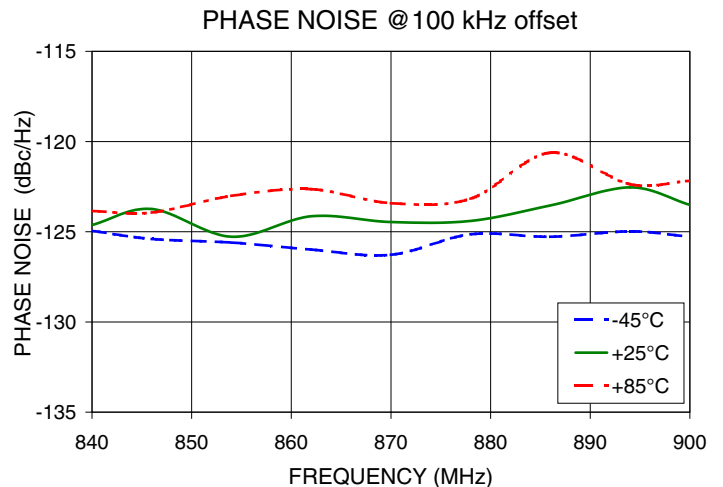
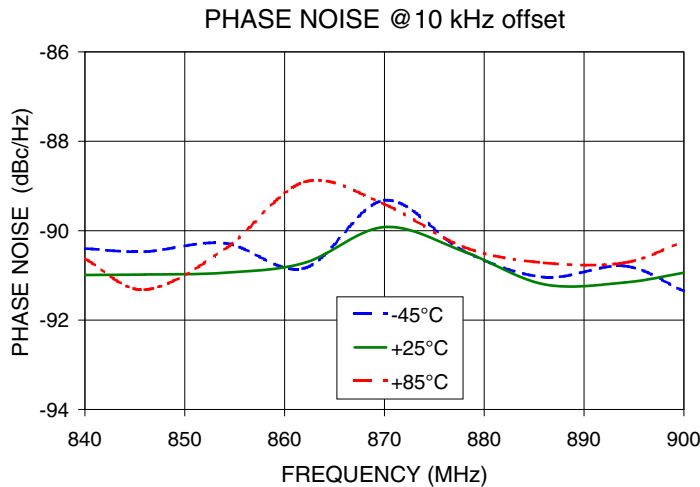
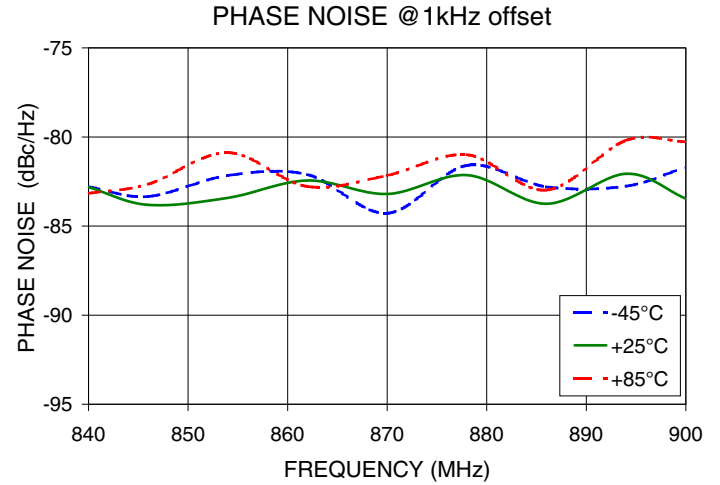
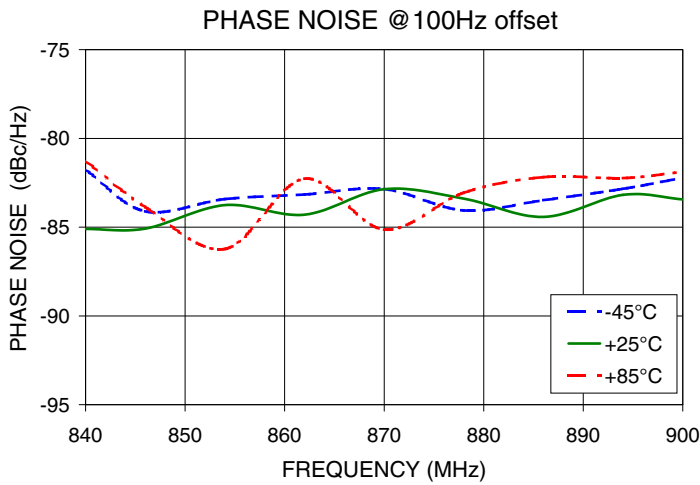

IF/RF MICROWAVE COMPONENTS • ISO 9001 ISO 14001 AS9100 CERTIFIED RoHS compliant
 P.O. Box 350166, Brooklyn, New York 11235-0003 (718) 934-4500 Fax (718) 332-4661



The Design Engineers Search Engine finds the model you need, Instantly • For detailed performance specs & shopping online see



Notes: 1. Performance and quality attributes and conditions not expressly stated in this specification sheet are intended to be excluded and do not form a part of this specification sheet. 2. Electrical specifications and performance data contained herein are based on Mini-Circuit's applicable established test performance criteria and measurement instructions. 3. The parts covered by this specification sheet are subject to Mini-Circuits standard limited warranty and terms and conditions (collectively, "Standard Terms"); Purchasers of this part are entitled to the rights and benefits contained therein. For a full statement of the Standard Terms and the exclusive rights and remedies thereunder, please visit Mini-Circuits' website at www.minicircuits.com/MCLStore/terms.jsp.

COMPARISON SPURIOUS
Vs FREQ. OFFSET @ Fcar = 840MHz

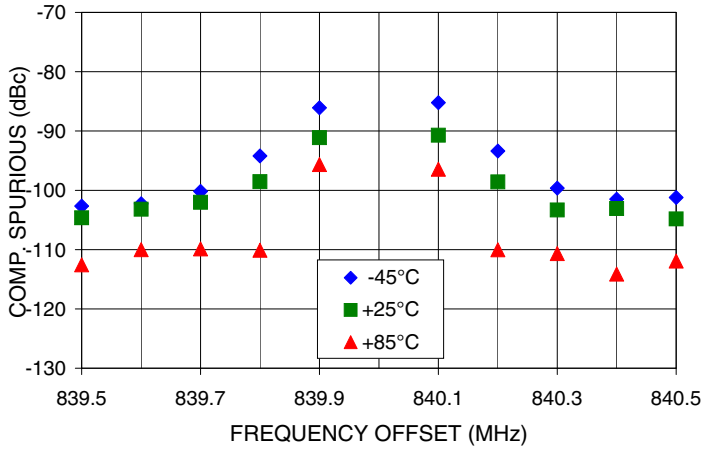

REFERENCE SPURIOUS
Vs FREQ. OFFSET @ Fcar = 840MHz

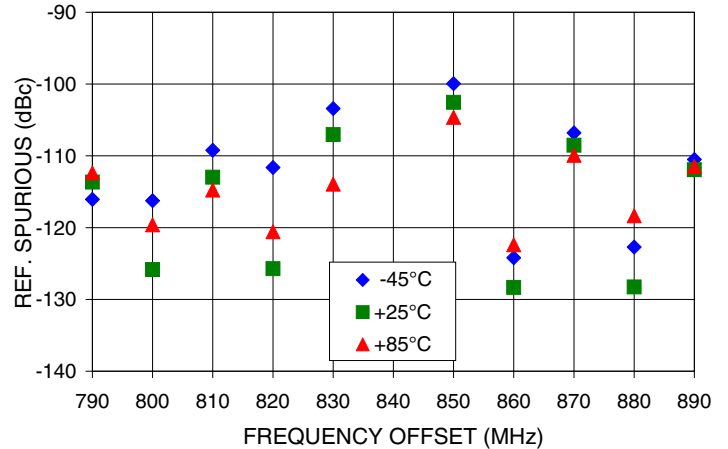

COMPARISON SPURIOUS
Vs FREQ. OFFSET @ Fcar = 870MHz

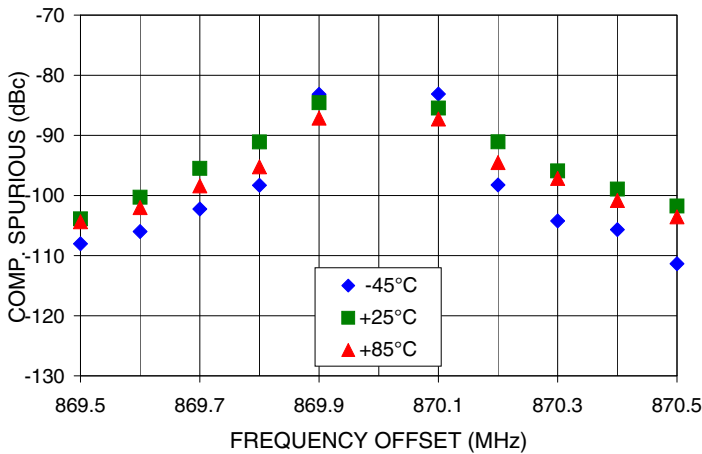

REFERENCE SPURIOUS
Vs FREQ. OFFSET @ Fcar = 870MHz

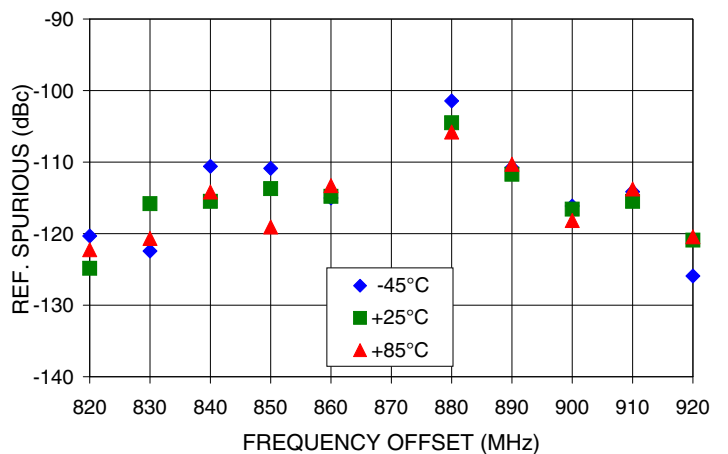

COMPARISON SPURIOUS
Vs FREQ. OFFSET @ Fcar = 900MHz

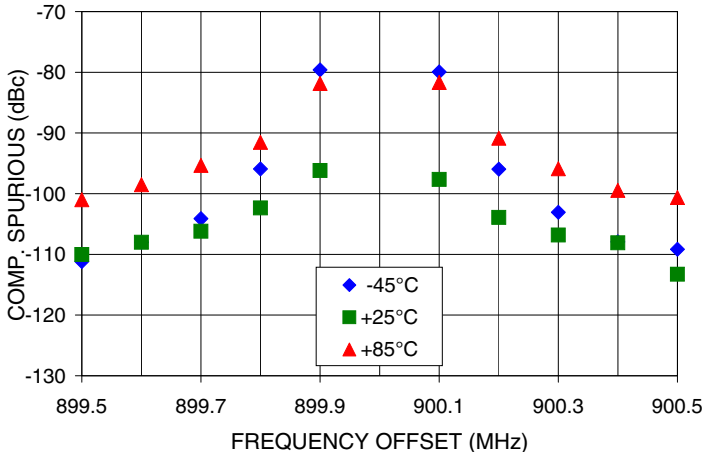

REFERENCE SPURIOUS
Vs FREQ. OFFSET @ Fcar = 900MHz

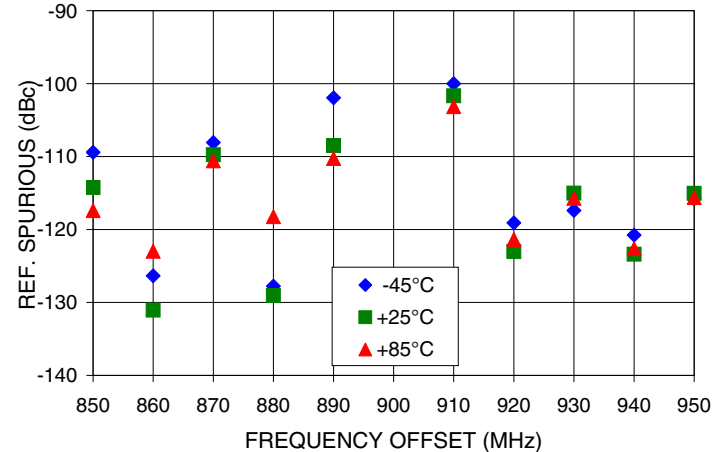

IF/RF MICROWAVE COMPONENTS • ISO 9001 ISO 14001 AS9100 CERTIFIED RoHS compliant
P.O. Box 350166, Brooklyn, New York 11235-0003 (718) 934-4500 Fax (718) 332-4661



The Design Engineers Search Engine finds the model you need, Instantly • For detailed performance specs & shopping online see



Notes: 1. Performance and quality attributes and conditions not expressly stated in this specification sheet are intended to be excluded and do not form a part of this specification sheet. 2. Electrical specifications and performance data contained herein are based on Mini-Circuit's applicable established test performance criteria and measurement instructions. 3. The parts covered by this specification sheet are subject to Mini-Circuits standard limited warranty and terms and conditions (collectively, "Standard Terms"); Purchasers of this part are entitled to the rights and benefits contained therein. For a full statement of the Standard Terms and the exclusive rights and remedies thereunder, please visit Mini-Circuits' website at www.minicircuits.com/MCLStore/terms.jsp.

Pin Configuration

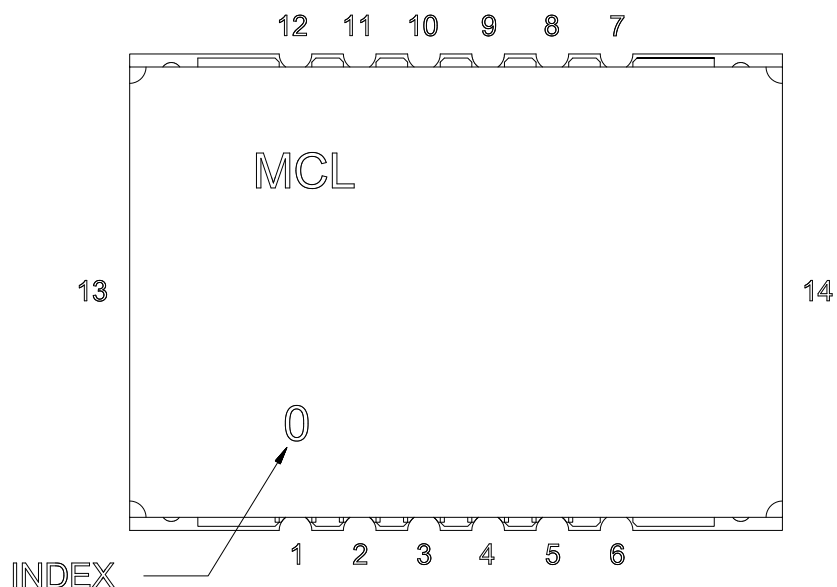

Pin Connection

Pin Number	Function
1	VCC PLL
2	GND
3	REF IN
4	GND
5	VCC VCO
6	GND
7	RF OUT
8	GND
9	LOCK DET
10	CLOCK
11	DATA
12	LE
13	GND
14	GND

Recommended Application Circuit

Note: REF IN and RF OUT ports are internally AC coupled.

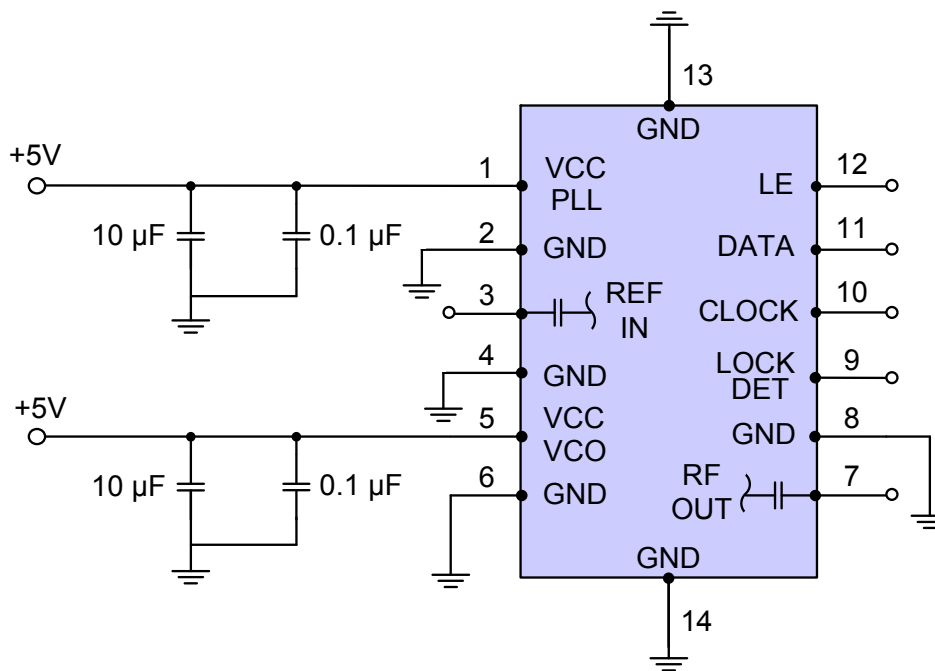

IF/RF MICROWAVE COMPONENTS • ISO 9001 ISO 14001 AS9100 CERTIFIED RoHS compliant
 P.O. Box 350166, Brooklyn, New York 11235-0003 (718) 934-4500 Fax (718) 332-4661



The Design Engineers Search Engine finds the model you need, Instantly • For detailed performance specs & shopping online see



Notes: 1. Performance and quality attributes and conditions not expressly stated in this specification sheet are intended to be excluded and do not form a part of this specification sheet. 2. Electrical specifications and performance data contained herein are based on Mini-Circuit's applicable established test performance criteria and measurement instructions. 3. The parts covered by this specification sheet are subject to Mini-Circuits standard limited warranty and terms and conditions (collectively, "Standard Terms"); Purchasers of this part are entitled to the rights and benefits contained therein. For a full statement of the Standard Terms and the exclusive rights and remedies thereunder, please visit Mini-Circuits' website at www.minicircuits.com/MCLStore/terms.jsp.

Device Marking

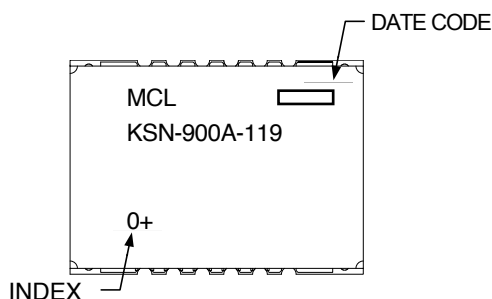

Additional Detailed Technical Information

Additional information is available on our web site. To access this information enter the model number on our web site home page.

Case Style: DK1042

Tape & Reel: TR-F28

Suggested Layout for PCB Design: PL-249

Evaluation Board: TB-567+

Environment Ratings: ENV03T2



IF/RF MICROWAVE COMPONENTS • ISO 9001 ISO 14001 AS9100 CERTIFIED RoHS compliant
P.O. Box 350166, Brooklyn, New York 11235-0003 (718) 934-4500 Fax (718) 332-4661



The Design Engineers Search Engine finds the model you need, Instantly • For detailed performance specs & shopping online see



Notes: 1. Performance and quality attributes and conditions not expressly stated in this specification sheet are intended to be excluded and do not form a part of this specification sheet. 2. Electrical specifications and performance data contained herein are based on Mini-Circuit's applicable established test performance criteria and measurement instructions. 3. The parts covered by this specification sheet are subject to Mini-Circuits standard limited warranty and terms and conditions (collectively, "Standard Terms"); Purchasers of this part are entitled to the rights and benefits contained therein. For a full statement of the Standard Terms and the exclusive rights and remedies thereunder, please visit Mini-Circuits' website at www.minicircuits.com/MCLStore/terms.jsp.