

Frequency Synthesizer

KSN-775A+

50Ω 740 to 775 MHz

The Big Deal

- Low phase noise and spurious
- Robust design and construction
- Small size 0.80" x 0.58" x 0.15"



CASE STYLE: DK1042

Product Overview

The KSN-775A+ is a Frequency Synthesizer, designed to operate from 740 to 775 MHz for W-CDMA application. The KSN-775A+ is packaged in a metal case (size of 0.80" x 0.58" x 0.15") to shield against unwanted signals and noise.

Key Features

Feature	Advantages
Low phase noise and spurious: <ul style="list-style-type: none">• Phase Noise: -105 dBc/Hz typ. @ 10 kHz offset• Comparison Spurious: -92 dBc typ.• Reference Spurious: -95 dBc typ.	Low phase noise and spurious improve system EVM (Error Vector Magnitude).
Robust design and construction	To enhance the robustness of KSN-775A+, each internal component is secured to the substrate with chip bonder, thereby eliminating the risk of tombstoning during subsequent solder reflow operations by the customer.
Small size, 0.80" x 0.58" x 0.15"	The small size enables the KSN-775A+ to be used in compact designs.



IF/RF MICROWAVE COMPONENTS • ISO 9001 ISO 14001 AS9100 CERTIFIED RoHS compliant
P.O. Box 350166, Brooklyn, New York 11235-0003 (718) 934-4500 Fax (718) 332-4661



The Design Engineers Search Engine finds the model you need, Instantly • For detailed performance specs & shopping online see



Notes: 1. Performance and quality attributes and conditions not expressly stated in this specification sheet are intended to be excluded and do not form a part of this specification sheet. 2. Electrical specifications and performance data contained herein are based on Mini-Circuit's applicable established test performance criteria and measurement instructions. 3. The parts covered by this specification sheet are subject to Mini-Circuits standard limited warranty and terms and conditions (collectively, "Standard Terms"); Purchasers of this part are entitled to the rights and benefits contained therein. For a full statement of the Standard Terms and the exclusive rights and remedies thereunder, please visit Mini-Circuits' website at www.minicircuits.com/MCLStore/terms.jsp.

50Ω 740 to 775 MHz

Features

- Integrated VCO + PLL
- Low phase noise and spurious
- Robust design and construction
- Low operating voltage (VCC VCO=+5V, VCC PLL=+3.3V)
- Small size 0.80" x 0.58" x 0.15"

Applications

- W-CDMA

General Description

The KSN-775A+ is a Frequency Synthesizer, designed to operate from 740 to 775 MHz for W-CDMA application. The KSN-775A+ is packaged in a metal case (size of 0.80" x 0.58" x 0.15") to shield against unwanted signals and noise. To enhance the robustness of KSN-775A+, each internal component is secured to the substrate with chip bonder, thereby eliminating the risk of tombstoning during subsequent solder reflow operations by the customer.



CASE STYLE: DK1042
PRICE: \$29.95 ea. QTY (1-9)

+ RoHS compliant in accordance with EU Directive (2002/95/EC)

The +Suffix has been added in order to identify RoHS Compliance. See our web site for RoHS Compliance methodologies and qualifications.

Simplified Schematic

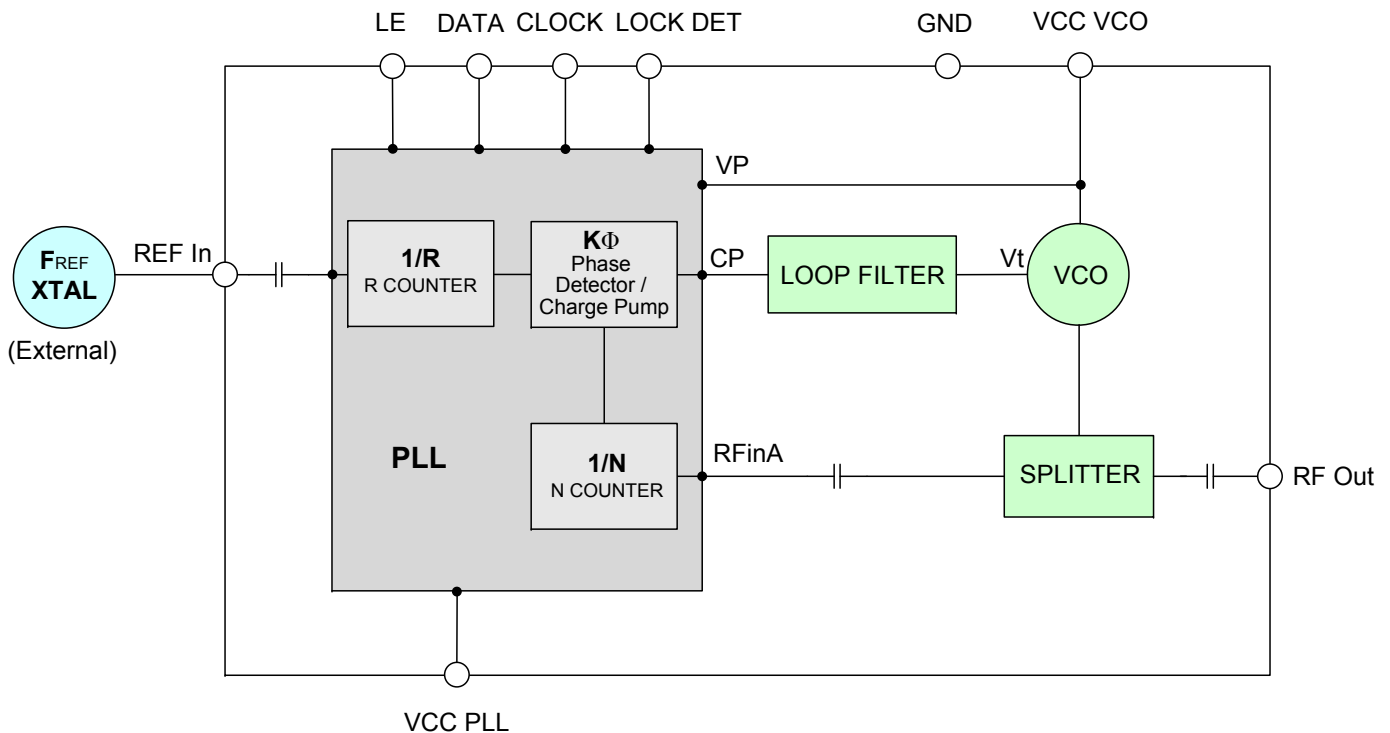

IF/RF MICROWAVE COMPONENTS • ISO 9001 ISO 14001 AS9100 CERTIFIED RoHS compliant
P.O. Box 350166, Brooklyn, New York 11235-0003 (718) 934-4500 Fax (718) 332-4661



The Design Engineers Search Engine finds the model you need, Instantly • For detailed performance specs & shopping online see



Notes: 1. Performance and quality attributes and conditions not expressly stated in this specification sheet are intended to be excluded and do not form a part of this specification sheet. 2. Electrical specifications and performance data contained herein are based on Mini-Circuit's applicable established test performance criteria and measurement instructions. 3. The parts covered by this specification sheet are subject to Mini-Circuits standard limited warranty and terms and conditions (collectively, "Standard Terms"); Purchasers of this part are entitled to the rights and benefits contained therein. For a full statement of the Standard Terms and the exclusive rights and remedies thereunder, please visit Mini-Circuits' website at www.minicircuits.com/MCLStore/terms.jsp.

Electrical Specifications (over operating temperature -40°C to +85°C)

Parameters	Test Conditions	Min.	Typ.	Max.	Units
Frequency Range	-	740	-	775	MHz
Step Size	-	-	200	-	kHz
Settling Time	Within ± 500 Hz	-	12	-	mSec
Output Power	-	0	+3.3	+6	dBm
SSB Phase Noise	@ 100 Hz offset	-	-84	-	dBc/Hz
	@ 1 kHz offset	-	-85	-80	
	@ 10 kHz offset	-	-105	-100	
	@ 100 kHz offset	-	-134	-129	
	@ 1 MHz offset	-	-155	-150	
Reference Spurious Suppression	Ref. Freq. 52 MHz	-	-95	-80	dBc
Comparison Spurious Suppression	Step Size 200 kHz	-	-92	-70	
Non - Harmonic Spurious Suppression	-	-	-90	-	
Harmonic Suppression	-	-	-33	-27	
VCO Supply Voltage	5.00	+4.75	5.00	+5.25	
PLL Supply Voltage	3.30	3.15	3.30	3.45	mA
VCO Supply Current	-	-	30	36	
PLL Supply Current	-	-	7	14	
Reference Input (External)	Frequency	52 (sine wave)	-	52	MHz
	Amplitude	1	-	1	V _{P-P}
	Input impedance	-	-	100	KΩ
	Phase Noise @ 1 kHz offset	-	-	-135	dBc/Hz
RF Output port Impedance	-	-	50	-	Ω
Input Logic Level	Input high voltage	-	2.75	-	V
	Input low voltage	-	-	0.60	V
Digital Lock Detect	Locked	-	2.60	-	V
	Unlocked	-	-	0.40	V
Frequency Synthesizer PLL	-	ADF4118			
PLL Programming	-	3-wire serial 3.3V CMOS			
Register Map @ 775 MHz	F_Register	-	(MSB) 10010010 (LSB)		
	N_Register	-	(MSB) 10000001110010001101 (LSB)		
	R_Register	-	(MSB) 100000000010000010000 (LSB)		

Absolute Maximum Ratings

Parameters	Ratings
VCO Supply Voltage	5.8V
PLL Supply Voltage	5.8V
VCO Supply Voltage to PLL Supply Voltage	-0.3V to +5.5V
Reference Frequency Voltage	-0.3Vmin, +3.3Vmax
Data, Clock, LE Levels	-0.3Vmin, +3.3Vmax
Operating Temperature	-40°C to +85°C
Storage Temperature	-55°C to +100°C

Permanent damage may occur if any of these limits are exceeded



IF/RF MICROWAVE COMPONENTS • ISO 9001 ISO 14001 AS9100 CERTIFIED RoHS compliant
 P.O. Box 350166, Brooklyn, New York 11235-0003 (718) 934-4500 Fax (718) 332-4661

The Design Engineers Search Engine finds the model you need, Instantly • For detailed performance specs & shopping online see minicircuits.com

Notes: 1. Performance and quality attributes and conditions not expressly stated in this specification sheet are intended to be excluded and do not form a part of this specification sheet. 2. Electrical specifications and performance data contained herein are based on Mini-Circuit's applicable established test performance criteria and measurement instructions. 3. The parts covered by this specification sheet are subject to Mini-Circuits standard limited warranty and terms and conditions (collectively, "Standard Terms"); Purchasers of this part are entitled to the rights and benefits contained therein. For a full statement of the Standard Terms and the exclusive rights and remedies thereunder, please visit Mini-Circuits' website at www.minicircuits.com/MCLStore/terms.jsp.

Typical Performance Data

FREQUENCY (MHz)	POWER OUTPUT (dBm)			VCO CURRENT (mA)			PLL CURENT (mA)		
	-45°C	+25°C	+85°C	-45°C	+25°C	+85°C	-45°C	+25°C	+85°C
	740.0	3.30	3.48	3.39	28.01	29.43	30.24	5.31	6.75
743.8	3.28	3.46	3.37	28.04	29.45	30.27	5.30	6.75	7.87
750.2	3.25	3.43	3.35	28.06	29.47	30.31	5.30	6.76	7.88
756.6	3.20	3.38	3.31	28.09	29.50	30.33	5.30	6.76	7.89
763.0	3.16	3.34	3.27	28.10	29.51	30.36	5.30	6.76	7.90
769.4	3.13	3.30	3.24	28.09	29.52	30.38	5.31	6.76	7.90
775.0	3.10	3.27	3.21	28.08	29.52	30.37	5.31	6.76	7.90

FREQUENCY (MHz)	HARMONICS (dBc)					
	F2			F3		
	-45°C	+25°C	+85°C	-45°C	+25°C	+85°C
740.0	-30.91	-32.62	-35.16	-51.07	-54.69	-59.17
743.8	-30.93	-32.58	-34.99	-52.21	-56.03	-60.81
750.2	-31.56	-33.24	-35.55	-51.78	-55.48	-61.15
756.6	-31.66	-33.41	-35.75	-52.78	-56.95	-62.07
763.0	-31.30	-33.06	-35.33	-53.12	-57.55	-61.75
769.4	-31.67	-33.36	-35.55	-54.62	-59.28	-64.42
775.0	-31.89	-33.52	-35.63	-54.89	-59.54	-64.15

FREQUENCY (MHz)	PHASE NOISE (dBc/Hz) @ OFFSETS				
	+25°C				
	100Hz	1kHz	10kHz	100kHz	1MHz
740.0	-87.87	-84.44	-105.60	-133.73	-155.65
743.8	-86.05	-85.07	-105.64	-133.90	-154.41
750.2	-85.42	-84.48	-105.43	-134.27	-154.67
756.6	-86.54	-85.09	-104.77	-134.31	-154.82
763.0	-87.06	-87.17	-104.90	-134.58	-156.81
769.4	-86.28	-86.32	-104.95	-134.58	-155.81
775.0	-85.15	-85.62	-105.75	-134.44	-156.31

FREQUENCY (MHz)	PHASE NOISE (dBc/Hz) @ OFFSETS				
	-45°C				
	100Hz	1kHz	10kHz	100kHz	1MHz
740.0	-83.51	-85.76	-104.88	-134.10	-153.55
743.8	-86.04	-86.78	-105.47	-134.29	-155.00
750.2	-85.36	-84.32	-105.12	-134.56	-154.48
756.6	-83.74	-86.00	-105.06	-134.91	-156.98
763.0	-85.00	-84.20	-104.85	-135.32	-157.32
769.4	-86.44	-83.05	-105.66	-135.18	-156.25
775.0	-86.99	-85.39	-105.59	-135.23	-157.51

FREQUENCY (MHz)	PHASE NOISE (dBc/Hz) @ OFFSETS				
	+85°C				
	100Hz	1kHz	10kHz	100kHz	1MHz
740.0	-85.07	-84.41	-104.67	-132.72	-153.67
743.8	-86.08	-85.95	-104.91	-132.76	-154.70
750.2	-86.50	-86.03	-104.58	-132.88	-153.11
756.6	-88.06	-87.51	-103.91	-132.98	-155.29
763.0	-87.75	-84.82	-104.43	-133.01	-155.41
769.4	-85.52	-85.97	-104.59	-133.21	-155.58
775.0	-86.01	-83.61	-104.42	-133.24	-155.54



IF/RF MICROWAVE COMPONENTS • ISO 9001 ISO 14001 AS9100 CERTIFIED RoHS compliant
 P.O. Box 350166, Brooklyn, New York 11235-0003 (718) 934-4500 Fax (718) 332-4661



The Design Engineers Search Engine finds the model you need, Instantly • For detailed performance specs & shopping online see



Notes: 1. Performance and quality attributes and conditions not expressly stated in this specification sheet are intended to be excluded and do not form a part of this specification sheet. 2. Electrical specifications and performance data contained herein are based on Mini-Circuit's applicable established test performance criteria and measurement instructions. 3. The parts covered by this specification sheet are subject to Mini-Circuits standard limited warranty and terms and conditions (collectively, "Standard Terms"); Purchasers of this part are entitled to the rights and benefits contained therein. For a full statement of the Standard Terms and the exclusive rights and remedies thereunder, please visit Mini-Circuits' website at www.minicircuits.com/MCLStore/terms.jsp.

COMPARISON SPURIOUS ORDER	COMPARISON SPURIOUS @Fcarrier 740MHz+(n*Fcomparison) (dBc) note 1			COMPARISON SPURIOUS @Fcarrier 757.6MHz+(n*Fcomparison) (dBc) note 1			COMPARISON SPURIOUS @Fcarrier 775MHz+(n*Fcomparison) (dBc) note 1		
	n	-45°C	+25°C	+85°C	-45°C	+25°C	+85°C	-45°C	+25°C
-5	-111.45	-112.28	-111.31	-110.99	-111.84	-109.18	-117.17	-113.84	-117.16
-4	-113.33	-111.56	-105.43	-109.48	-107.51	-108.99	-117.26	-114.64	-111.92
-3	-101.10	-101.93	-98.98	-101.15	-99.99	-100.45	-100.86	-101.02	-113.35
-2	-108.12	-96.49	-93.10	-97.26	-98.58	-96.07	-109.22	-106.47	-106.36
-1	-95.76	-87.46	-86.82	-94.30	-92.62	-90.30	-96.80	-98.76	-96.67
0 ^{note 2}	-	-	-	-	-	-	-	-	-
+1	-97.36	-88.21	-86.90	-91.74	-93.26	-90.79	-94.63	-94.50	-93.79
+2	-109.30	-95.87	-93.95	-97.85	-96.28	-95.55	-108.47	-110.09	-107.19
+3	-100.48	-102.29	-98.14	-102.00	-102.15	-101.21	-100.91	-101.09	-110.46
+4	-112.08	-109.05	-105.75	-108.68	-109.61	-108.24	-115.64	-118.66	-114.23
+5	-110.16	-111.16	-114.21	-111.89	-112.71	-109.18	-115.90	-117.35	-114.78

Note 1: Comparison frequency 200 kHz

Note 2: All spurs are referenced to carrier signal (n=0).

REFERENCE SPURIOUS ORDER	REFERENCE SPURIOUS @Fcarrier 740MHz+(n*Freference) (dBc) note 3			REFERENCE SPURIOUS @Fcarrier 757.6MHz+(n*Freference) (dBc) note 3			REFERENCE SPURIOUS @Fcarrier 775MHz+(n*Freference) (dBc) note 3		
	n	-45°C	+25°C	+85°C	-45°C	+25°C	+85°C	-45°C	+25°C
-5	-117.30	-125.13	-114.32	-119.54	-117.71	-114.95	-115.35	-115.28	-111.90
-4	-97.06	-97.81	-99.51	-96.92	-97.07	-97.93	-95.21	-95.57	-96.39
-3	-100.81	-101.45	-102.96	-98.19	-98.65	-100.14	-94.99	-95.48	-96.81
-2	-91.47	-92.76	-94.04	-104.28	-106.22	-106.37	-107.39	-109.95	-111.51
-1	-107.10	-108.28	-109.93	-107.19	-108.49	-110.29	-106.95	-108.52	-109.32
0 ^{note 4}	-	-	-	-	-	-	-	-	-
+1	-106.78	-106.32	-107.18	-106.21	-106.07	-106.53	-106.71	-106.08	-106.02
+2	-108.49	-108.33	-108.34	-104.62	-106.36	-107.89	-102.96	-104.81	-105.80
+3	-106.05	-107.18	-106.95	-105.48	-106.67	-106.69	-103.79	-104.13	-104.25
+4	-103.66	-103.81	-105.59	-103.76	-104.50	-105.68	-103.96	-103.75	-105.33
+5	-119.45	-120.56	-119.04	-118.41	-128.90	-123.50	-128.17	-128.96	-124.91

Note 3: Reference frequency 52 MHz

Note 4: All spurs are referenced to carrier signal (n=0).



IF/RF MICROWAVE COMPONENTS • ISO 9001 ISO 14001 AS9100 CERTIFIED RoHS compliant
P.O. Box 350166, Brooklyn, New York 11235-0003 (718) 934-4500 Fax (718) 332-4661



The Design Engineers Search Engine finds the model you need, Instantly • For detailed performance specs & shopping online see



Notes: 1. Performance and quality attributes and conditions not expressly stated in this specification sheet are intended to be excluded and do not form a part of this specification sheet. 2. Electrical specifications and performance data contained herein are based on Mini-Circuit's applicable established test performance criteria and measurement instructions. 3. The parts covered by this specification sheet are subject to Mini-Circuits standard limited warranty and terms and conditions (collectively, "Standard Terms"); Purchasers of this part are entitled to the rights and benefits contained therein. For a full statement of the Standard Terms and the exclusive rights and remedies thereunder, please visit Mini-Circuits' website at www.minicircuits.com/MCLStore/terms.jsp.

Typical Performance Curves

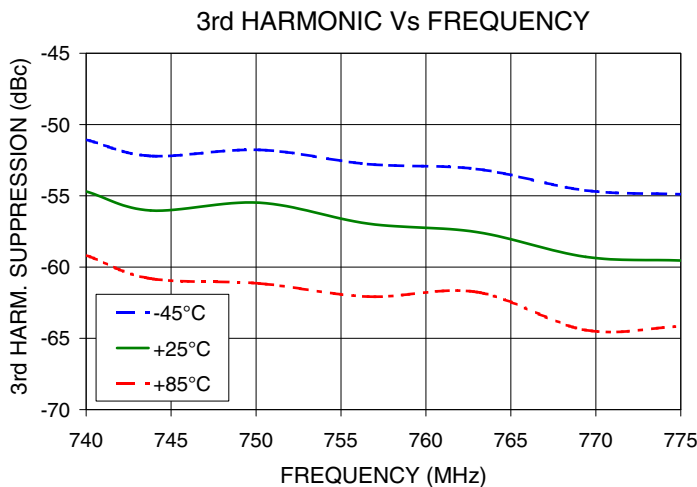
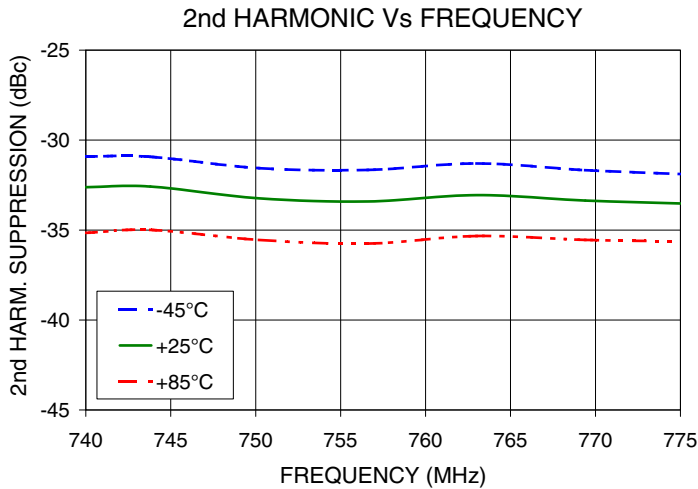
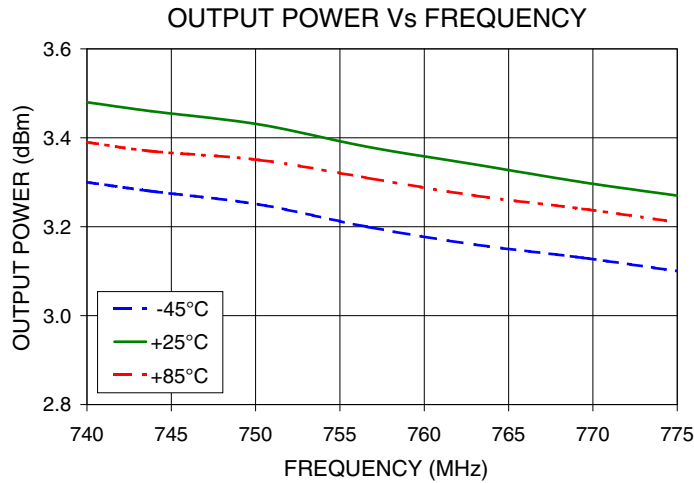

IF/RF MICROWAVE COMPONENTS • ISO 9001 ISO 14001 AS9100 CERTIFIED RoHS compliant
 P.O. Box 350166, Brooklyn, New York 11235-0003 (718) 934-4500 Fax (718) 332-4661



The Design Engineers Search Engine finds the model you need, Instantly • For detailed performance specs & shopping online see



Notes: 1. Performance and quality attributes and conditions not expressly stated in this specification sheet are intended to be excluded and do not form a part of this specification sheet. 2. Electrical specifications and performance data contained herein are based on Mini-Circuit's applicable established test performance criteria and measurement instructions. 3. The parts covered by this specification sheet are subject to Mini-Circuits standard limited warranty and terms and conditions (collectively, "Standard Terms"); Purchasers of this part are entitled to the rights and benefits contained therein. For a full statement of the Standard Terms and the exclusive rights and remedies thereunder, please visit Mini-Circuits' website at www.minicircuits.com/MCLStore/terms.jsp.

PHASE NOISE @ 100Hz offset

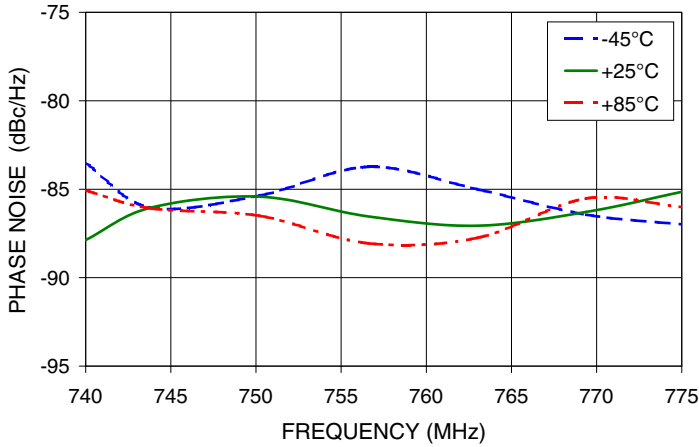

PHASE NOISE @ 1kHz offset

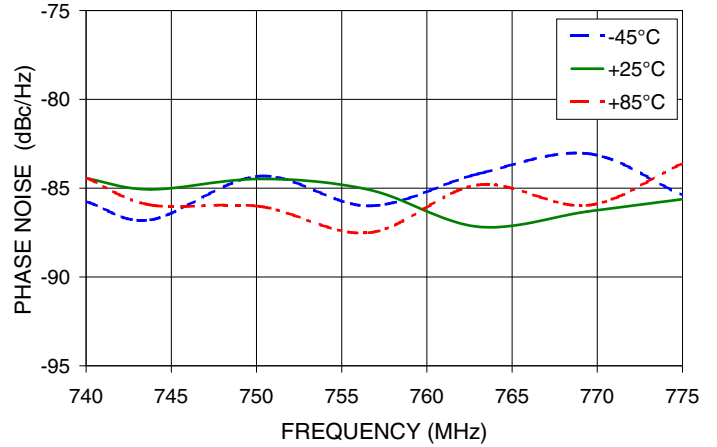

PHASE NOISE @ 10kHz offset

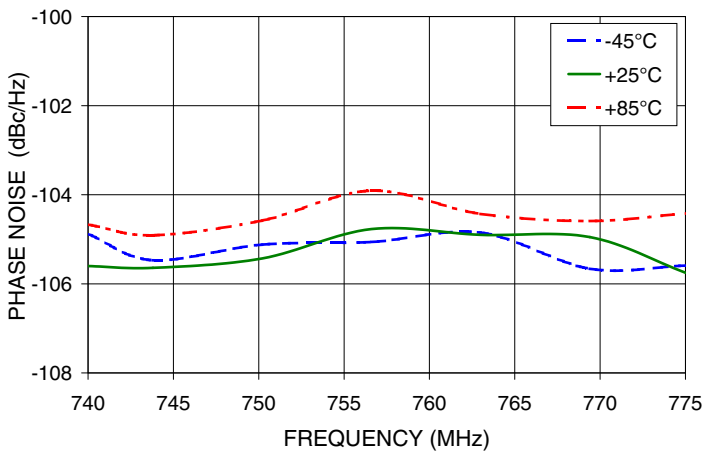

PHASE NOISE @ 100kHz offset

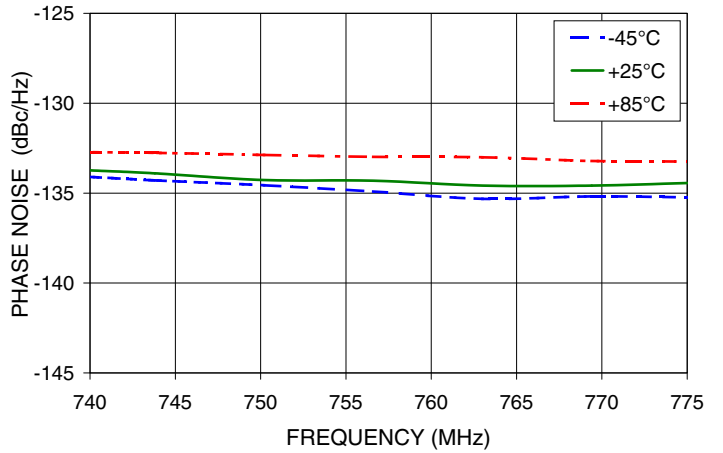

PHASE NOISE @ 1MHz offset

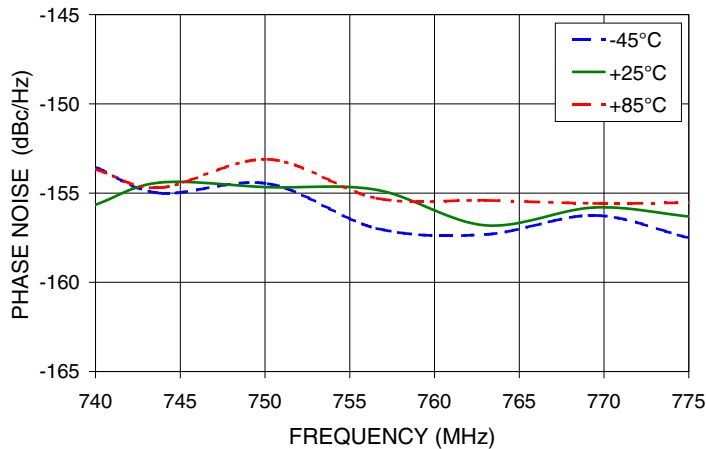

IF/RF MICROWAVE COMPONENTS • ISO 9001 ISO 14001 AS9100 CERTIFIED RoHS compliant
 P.O. Box 350166, Brooklyn, New York 11235-0003 (718) 934-4500 Fax (718) 332-4661



The Design Engineers Search Engine finds the model you need, Instantly • For detailed performance specs & shopping online see



Notes: 1. Performance and quality attributes and conditions not expressly stated in this specification sheet are intended to be excluded and do not form a part of this specification sheet. 2. Electrical specifications and performance data contained herein are based on Mini-Circuit's applicable established test performance criteria and measurement instructions. 3. The parts covered by this specification sheet are subject to Mini-Circuits standard limited warranty and terms and conditions (collectively, "Standard Terms"); Purchasers of this part are entitled to the rights and benefits contained therein. For a full statement of the Standard Terms and the exclusive rights and remedies thereunder, please visit Mini-Circuits' website at www.minicircuits.com/MCLStore/terms.jsp.

COMPARISON SPURIOUS
Vs FREQ. OFFSET @ Fcar = 740MHz

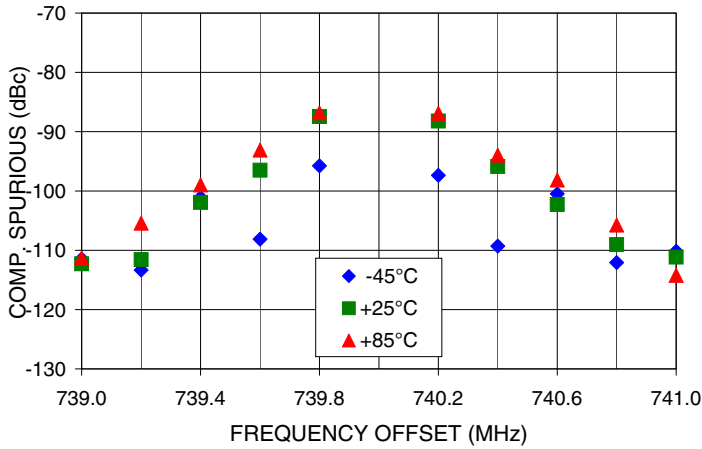

REFERENCE SPURIOUS
Vs FREQ. OFFSET @ Fcar = 740MHz

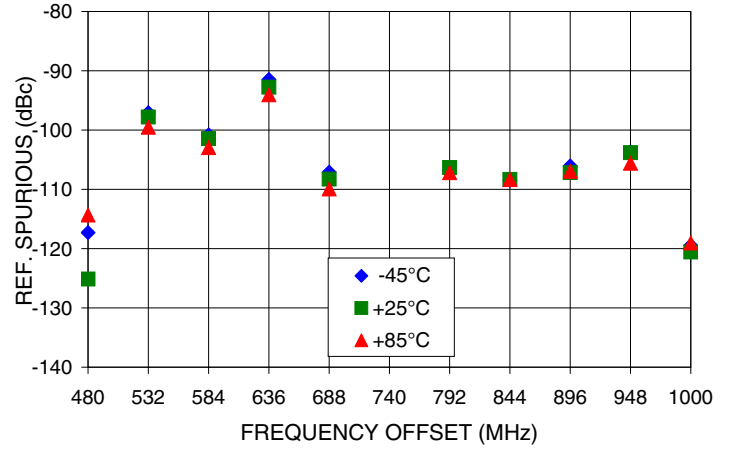

COMPARISON SPURIOUS
Vs FREQ. OFFSET @ Fcar = 757.6MHz

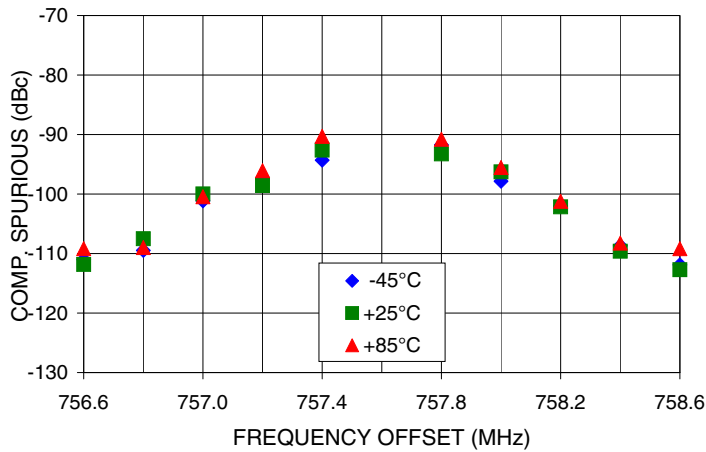

REFERENCE SPURIOUS
Vs FREQ. OFFSET @ Fcar = 757.6MHz

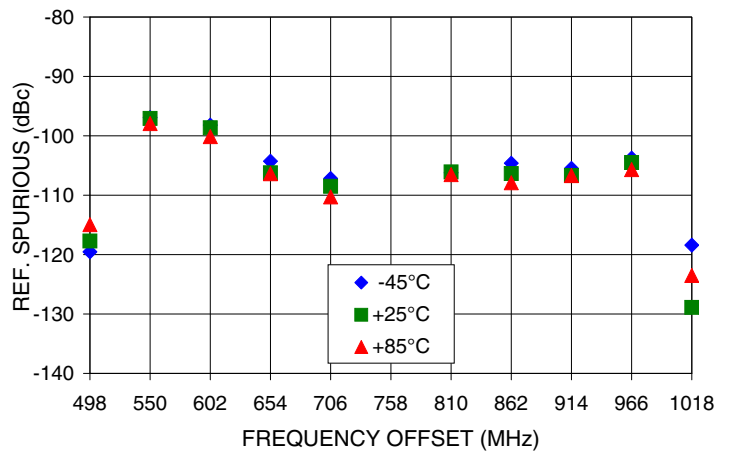

COMPARISON SPURIOUS
Vs FREQ. OFFSET @ Fcar = 775MHz

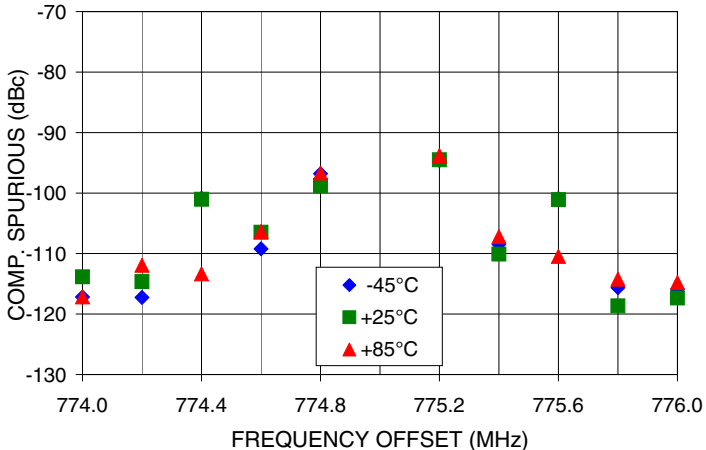

REFERENCE SPURIOUS
Vs FREQ. OFFSET @ Fcar = 775MHz

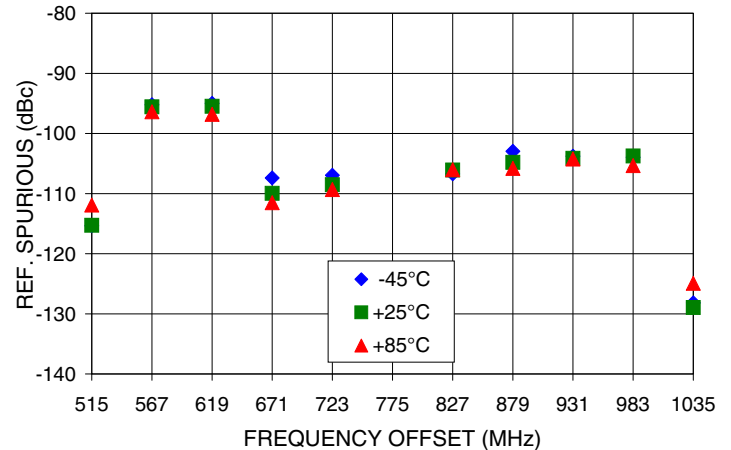

IF/RF MICROWAVE COMPONENTS • ISO 9001 ISO 14001 AS9100 CERTIFIED RoHS compliant
P.O. Box 350166, Brooklyn, New York 11235-0003 (718) 934-4500 Fax (718) 332-4661



The Design Engineers Search Engine finds the model you need, Instantly • For detailed performance specs & shopping online see



Notes: 1. Performance and quality attributes and conditions not expressly stated in this specification sheet are intended to be excluded and do not form a part of this specification sheet. 2. Electrical specifications and performance data contained herein are based on Mini-Circuit's applicable established test performance criteria and measurement instructions. 3. The parts covered by this specification sheet are subject to Mini-Circuits standard limited warranty and terms and conditions (collectively, "Standard Terms"); Purchasers of this part are entitled to the rights and benefits contained therein. For a full statement of the Standard Terms and the exclusive rights and remedies thereunder, please visit Mini-Circuits' website at www.minicircuits.com/MCLStore/terms.jsp.

Pin Configuration

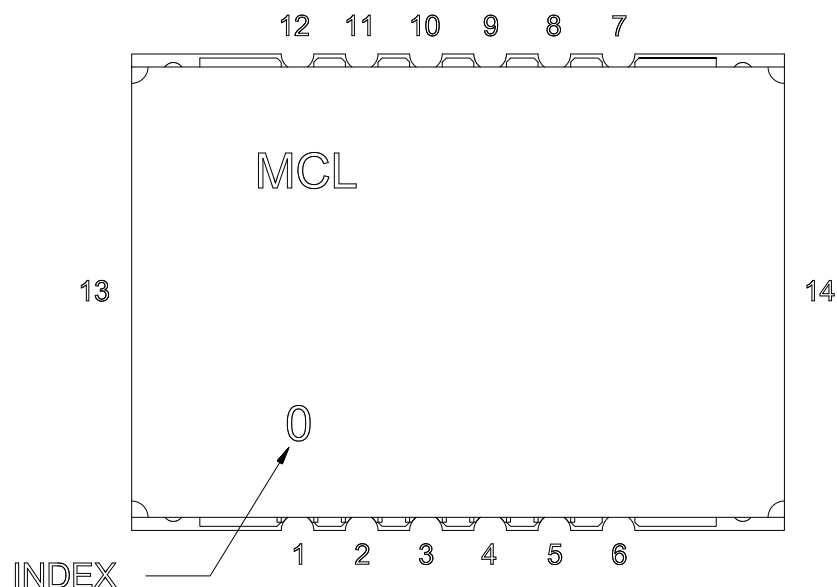

Pin Connection

Pin Number	Function
1	VCC PLL
2	GND
3	REF IN
4	GND
5	VCC VCO
6	GND
7	RF OUT
8	GND
9	LOCK DET
10	CLOCK
11	DATA
12	LE
13	GND
14	GND

Recommended Application Circuit

Note: REF IN and RF OUT ports are internally AC coupled.

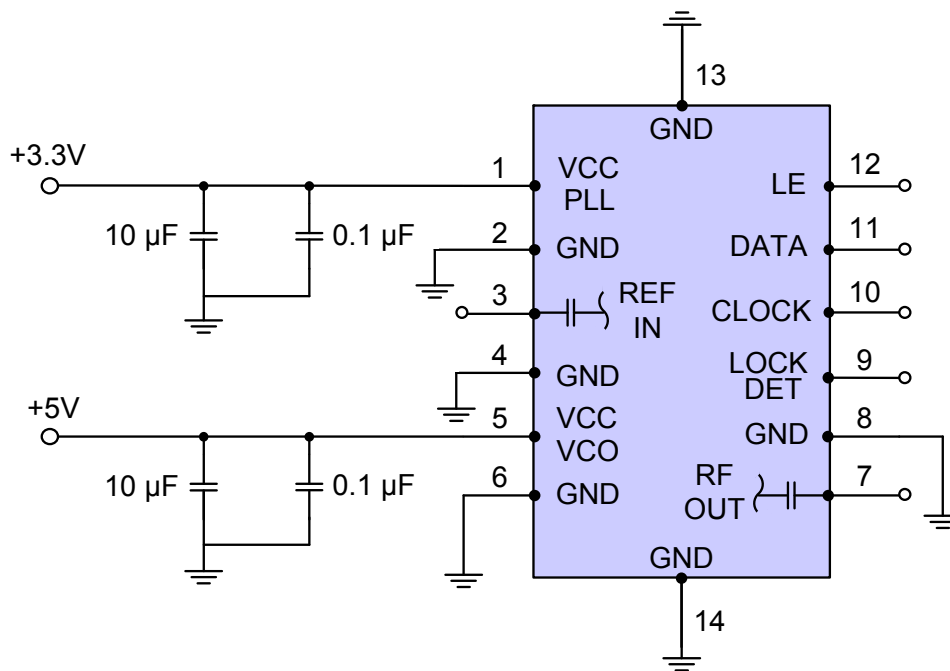

IF/RF MICROWAVE COMPONENTS • ISO 9001 ISO 14001 AS9100 CERTIFIED RoHS compliant
 P.O. Box 350166, Brooklyn, New York 11235-0003 (718) 934-4500 Fax (718) 332-4661



The Design Engineers Search Engine finds the model you need, Instantly • For detailed performance specs & shopping online see



Notes: 1. Performance and quality attributes and conditions not expressly stated in this specification sheet are intended to be excluded and do not form a part of this specification sheet. 2. Electrical specifications and performance data contained herein are based on Mini-Circuit's applicable established test performance criteria and measurement instructions. 3. The parts covered by this specification sheet are subject to Mini-Circuits standard limited warranty and terms and conditions (collectively, "Standard Terms"); Purchasers of this part are entitled to the rights and benefits contained therein. For a full statement of the Standard Terms and the exclusive rights and remedies thereunder, please visit Mini-Circuits' website at www.minicircuits.com/MCLStore/terms.jsp.

Device Marking

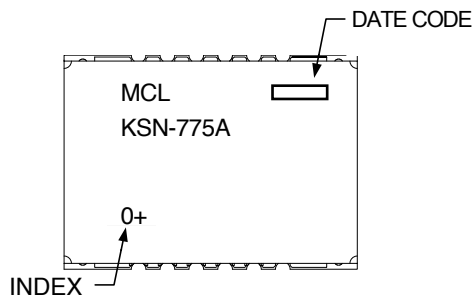
**Additional Detailed Technical Information**

Additional information is available on our web site. To access this information enter the model number on our web site home page.

Case Style: DK1042

Tape & Reel: TR-F28

Suggested Layout for PCB Design: PL-249

Evaluation Board: TB-567-1+

Environment Ratings: ENV03T2



IF/RF MICROWAVE COMPONENTS • ISO 9001 ISO 14001 AS9100 CERTIFIED RoHS compliant
P.O. Box 350166, Brooklyn, New York 11235-0003 (718) 934-4500 Fax (718) 332-4661



The Design Engineers Search Engine finds the model you need, Instantly • For detailed performance specs & shopping online see



Notes: 1. Performance and quality attributes and conditions not expressly stated in this specification sheet are intended to be excluded and do not form a part of this specification sheet. 2. Electrical specifications and performance data contained herein are based on Mini-Circuit's applicable established test performance criteria and measurement instructions. 3. The parts covered by this specification sheet are subject to Mini-Circuits standard limited warranty and terms and conditions (collectively, "Standard Terms"); Purchasers of this part are entitled to the rights and benefits contained therein. For a full statement of the Standard Terms and the exclusive rights and remedies thereunder, please visit Mini-Circuits' website at www.minicircuits.com/MCLStore/terms.jsp.