

Frequency Synthesizer

KSN-2300A-119+

50Ω 2100 to 2300 MHz

The Big Deal

- Low phase noise and spurious
- Robust design and construction
- Small size 0.80" x 0.58" x 0.15"



CASE STYLE: DK1042

Product Overview

The KSN-2300A-119+ is a Frequency Synthesizer, designed to operate from 2100 to 2300 MHz for TD-SCDMA application. The KSN-2300A-119+ is packaged in a metal case (size of 0.80" x 0.58" x 0.15") to shield against unwanted signals and noise.

Key Features

Feature	Advantages
Low phase noise and spurious: <ul style="list-style-type: none">• Phase Noise: -97 dBc/Hz typ. @ 10 kHz offset• Comparison Spurious: -98 dBc typ.• Reference Spurious: -104 dBc typ.	Low phase noise and spurious improve system EVM (Error Vector Magnitude).
Robust design and construction	To enhance the robustness of KSN-2300A-119+, each internal component is secured to the substrate with chip bonder, thereby eliminating the risk of tombstoning during subsequent solder reflow operations by the customer.
Small size, 0.80" x 0.58" x 0.15"	The small size enables the KSN-2300A-119+ to be used in compact designs.



IF/RF MICROWAVE COMPONENTS • ISO 9001 ISO 14001 AS9100 CERTIFIED RoHS compliant
P.O. Box 350166, Brooklyn, New York 11235-0003 (718) 934-4500 Fax (718) 332-4661



The Design Engineers Search Engine finds the model you need, Instantly • For detailed performance specs & shopping online see



Notes: 1. Performance and quality attributes and conditions not expressly stated in this specification sheet are intended to be excluded and do not form a part of this specification sheet. 2. Electrical specifications and performance data contained herein are based on Mini-Circuit's applicable established test performance criteria and measurement instructions. 3. The parts covered by this specification sheet are subject to Mini-Circuits standard limited warranty and terms and conditions (collectively, "Standard Terms"); Purchasers of this part are entitled to the rights and benefits contained therein. For a full statement of the Standard Terms and the exclusive rights and remedies thereunder, please visit Mini-Circuits' website at www.minicircuits.com/MCLStore/terms.jsp.

50Ω 2100 to 2300 MHz

Features

- Integrated VCO + PLL
- Low phase noise and spurious
- Robust design and construction
- Low operating voltage (VCC VCO=+5V, VCC PLL=+5V)
- Small size 0.80" x 0.58" x 0.15"

Applications

- TD-SCDMA

General Description

The KSN-2300A-119+ is a Frequency Synthesizer, designed to operate from 2100 to 2300 MHz for TD-SCDMA application. The KSN-2300A-119+ is packaged in a metal case (size of 0.80" x 0.58" x 0.15") to shield against unwanted signals and noise. To enhance the robustness of KSN-2300A-119+, each internal component is secured to the substrate with chip bonder, thereby eliminating the risk of tombstoning during subsequent solder reflow operations by the customer.



CASE STYLE: DK1042
PRICE: \$29.95 ea. QTY (1-9)

+ RoHS compliant in accordance with EU Directive (2002/95/EC)

The +Suffix has been added in order to identify RoHS Compliance. See our web site for RoHS Compliance methodologies and qualifications.

Simplified Schematic

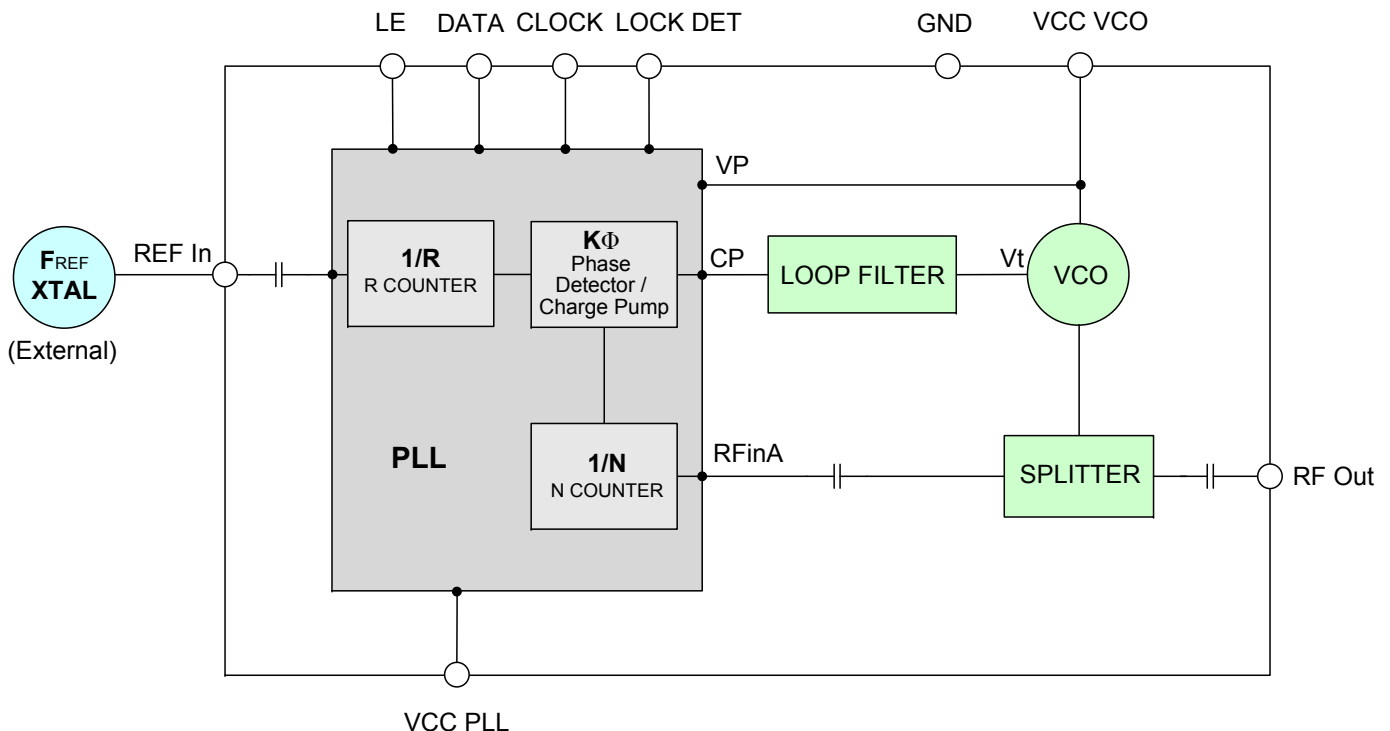

IF/RF MICROWAVE COMPONENTS • ISO 9001 ISO 14001 AS9100 CERTIFIED RoHS compliant
P.O. Box 350166, Brooklyn, New York 11235-0003 (718) 934-4500 Fax (718) 332-4661



The Design Engineers Search Engine finds the model you need, Instantly • For detailed performance specs & shopping online see



Notes: 1. Performance and quality attributes and conditions not expressly stated in this specification sheet are intended to be excluded and do not form a part of this specification sheet. 2. Electrical specifications and performance data contained herein are based on Mini-Circuit's applicable established test performance criteria and measurement instructions. 3. The parts covered by this specification sheet are subject to Mini-Circuits standard limited warranty and terms and conditions (collectively, "Standard Terms"); Purchasers of this part are entitled to the rights and benefits contained therein. For a full statement of the Standard Terms and the exclusive rights and remedies thereunder, please visit Mini-Circuits' website at www.minicircuits.com/MCLStore/terms.jsp.

Electrical Specifications (over operating temperature -40°C to +85°C)

Parameters	Test Conditions	Min.	Typ.	Max.	Units
Frequency Range	-	2100	-	2300	MHz
Step Size	-	-	200	-	kHz
Settling Time	Within ± 1 kHz	-	5	-	mSec
Output Power	-	+2.0	+4.5	+7.0	dBm
SSB Phase Noise	@ 100 Hz offset	-	-80	-	dBc/Hz
	@ 1 kHz offset	-	-81	-75	
	@ 10 kHz offset	-	-97	-93	
	@ 100 kHz offset	-	-126	-121	
	@ 1 MHz offset	-	-146	-141	
Integrated SSB Phase Noise	@ 1 kHz to 5 MHz	-	-43	-40	dBc
Reference Spurious Suppression	Ref. Freq. 76.8 MHz	-	-104	-72	dBc
Comparison Spurious Suppression	Step Size 200 kHz	-	-98	-75	
Non - Harmonic Spurious Suppression	-	-	-90	-	
Harmonic Suppression	-	-	-46	-30	
VCO Supply Voltage	5.00	4.75	5.00	5.25	V
PLL Supply Voltage	5.00	4.75	5.00	5.25	
VCO Supply Current	-	-	44	51	mA
PLL Supply Current	-	-	19	26	
Reference Input (External)	Frequency	76.8 (square wave)	-	76.8	MHz
	Amplitude	1	-	1	V _{P-P}
	Input impedance	-	-	100	KΩ
	Phase Noise @ 1 kHz offset	-	-	-145	dBc/Hz
RF Output port Impedance	-	-	50	-	Ω
Input Logic Level	Input high voltage	-	2.85	-	V
	Input low voltage	-	-	0.60	V
Digital Lock Detect	Locked	-	2.80	3.55	V
	Unlocked	-	-	0.40	V
Frequency Synthesizer PLL	-	ADF4106			
PLL Programming	-	3-wire serial 3.3V CMOS			
Register Map @ 2300 MHz	F_Register	-	(MSB) 101111100000010010011 (LSB)		
	N_Register	-	(MSB) 101100111000110001 (LSB)		
	R_Register	-	(MSB) 10000000011000000000 (LSB)		

Absolute Maximum Ratings

Parameters	Ratings
VCO Supply Voltage	5.8V
PLL Supply Voltage	5.3V
VCO Supply Voltage to PLL Supply Voltage	-0.3V to +5.8V
Reference Frequency Voltage	-0.3Vmin, +3.5Vmax
Data, Clock, LE Levels	-0.3Vmin, +3.5Vmax
Operating Temperature	-40°C to +85°C
Storage Temperature	-55°C to +100°C

Permanent damage may occur if any of these limits are exceeded



IF/RF MICROWAVE COMPONENTS • ISO 9001 ISO 14001 AS9100 CERTIFIED RoHS compliant

P.O. Box 350166, Brooklyn, New York 11235-0003 (718) 934-4500 Fax (718) 332-4661



The Design Engineers Search Engine finds the model you need, Instantly • For detailed performance specs & shopping online see



Notes: 1. Performance and quality attributes and conditions not expressly stated in this specification sheet are intended to be excluded and do not form a part of this specification sheet. 2. Electrical specifications and performance data contained herein are based on Mini-Circuit's applicable established test performance criteria and measurement instructions. 3. The parts covered by this specification sheet are subject to Mini-Circuits standard limited warranty and terms and conditions (collectively, "Standard Terms"); Purchasers of this part are entitled to the rights and benefits contained therein. For a full statement of the Standard Terms and the exclusive rights and remedies thereunder, please visit Mini-Circuits' website at www.minicircuits.com/MCLStore/terms.jsp.

Typical Performance Data

FREQUENCY (MHz)	POWER OUTPUT (dBm)			VCO CURRENT (mA)			PLL CURENT (mA)		
	-45°C	+25°C	+85°C	-45°C	+25°C	+85°C	-45°C	+25°C	+85°C
	2100.0	4.64	4.66	4.49	41.57	43.30	44.57	18.56	19.20
2120.0	4.56	4.58	4.40	41.71	43.45	44.70	18.57	19.21	20.68
2140.0	4.52	4.51	4.32	41.87	43.59	44.82	18.57	19.22	20.68
2160.0	4.53	4.52	4.30	42.03	43.74	44.94	18.58	19.23	20.69
2180.0	4.59	4.56	4.36	42.19	43.88	45.08	18.59	19.24	20.70
2200.0	4.57	4.55	4.35	42.35	44.03	45.21	18.59	19.25	20.71
2220.0	4.58	4.53	4.34	42.52	44.19	45.35	18.60	19.26	20.72
2240.0	4.60	4.54	4.35	42.70	44.36	45.50	18.61	19.27	20.73
2260.0	4.64	4.57	4.37	42.89	44.53	45.65	18.61	19.27	20.74
2280.0	4.69	4.63	4.42	43.08	44.71	45.81	18.62	19.28	20.75
2300.0	4.68	4.62	4.42	43.28	44.89	45.97	18.63	19.29	20.76

FREQUENCY (MHz)	HARMONICS (dBc)					
	F2			F3		
	-45°C	+25°C	+85°C	-45°C	+25°C	+85°C
2100.00	-43.68	-40.67	-33.29	-34.40	-38.60	-33.29
2120.00	-48.50	-44.90	-34.46	-35.73	-39.51	-34.46
2140.00	-50.88	-41.08	-34.26	-37.02	-43.03	-34.26
2160.00	-48.45	-41.69	-33.79	-38.11	-44.07	-33.79
2180.00	-52.10	-43.73	-35.13	-40.78	-43.65	-35.13
2200.00	-44.97	-40.83	-34.07	-38.46	-44.13	-34.07
2220.00	-39.69	-48.26	-36.49	-37.11	-41.50	-36.49
2240.00	-39.76	-45.30	-36.69	-38.50	-43.51	-36.69
2260.00	-42.44	-41.95	-34.75	-41.06	-45.57	-34.75
2280.00	-38.80	-44.22	-36.55	-39.85	-44.84	-36.55
2300.00	-38.82	-42.15	-38.35	-40.00	-45.08	-38.35



IF/RF MICROWAVE COMPONENTS • ISO 9001 ISO 14001 AS9100 CERTIFIED RoHS compliant
 P.O. Box 350166, Brooklyn, New York 11235-0003 (718) 934-4500 Fax (718) 332-4661



The Design Engineers Search Engine finds the model you need, Instantly • For detailed performance specs & shopping online see



Notes: 1. Performance and quality attributes and conditions not expressly stated in this specification sheet are intended to be excluded and do not form a part of this specification sheet. 2. Electrical specifications and performance data contained herein are based on Mini-Circuit's applicable established test performance criteria and measurement instructions. 3. The parts covered by this specification sheet are subject to Mini-Circuits standard limited warranty and terms and conditions (collectively, "Standard Terms"); Purchasers of this part are entitled to the rights and benefits contained therein. For a full statement of the Standard Terms and the exclusive rights and remedies thereunder, please visit Mini-Circuits' website at www.minicircuits.com/MCLStore/terms.jsp.

FREQUENCY (MHz)	PHASE NOISE (dBc/Hz) @ OFFSETS				
	+25°C				
	100Hz	1kHz	10kHz	100kHz	1MHz
2100.0	-79.68	-82.86	-97.72	-125.71	-146.18
2120.0	-79.94	-82.19	-97.80	-125.98	-146.53
2140.0	-80.16	-81.76	-97.84	-126.16	-146.95
2160.0	-80.12	-82.01	-97.80	-126.34	-147.42
2180.0	-79.98	-82.64	-97.69	-126.52	-147.72
2200.0	-80.13	-83.19	-97.49	-126.70	-147.57
2220.0	-80.15	-83.03	-97.61	-126.78	-146.79
2240.0	-80.09	-82.04	-97.80	-126.86	-147.57
2260.0	-80.02	-81.06	-98.03	-126.90	-148.43
2280.0	-79.92	-80.55	-98.33	-126.87	-148.36
2300.0	-79.47	-79.36	-98.94	-126.60	-147.72

FREQUENCY (MHz)	PHASE NOISE (dBc/Hz) @ OFFSETS				
	-45°C				
	100Hz	1kHz	10kHz	100kHz	1MHz
2100.0	-78.25	-82.87	-97.53	-126.13	-147.47
2120.0	-78.60	-82.72	-97.66	-126.38	-147.71
2140.0	-78.40	-82.07	-97.79	-126.59	-148.24
2160.0	-78.00	-81.57	-97.94	-126.78	-148.59
2180.0	-77.98	-81.42	-98.04	-126.92	-148.11
2200.0	-78.03	-81.61	-97.90	-127.10	-148.38
2220.0	-78.00	-83.05	-97.45	-127.23	-148.84
2240.0	-78.07	-83.36	-97.31	-127.31	-149.08
2260.0	-78.26	-82.34	-97.60	-127.35	-149.10
2280.0	-78.36	-81.98	-97.97	-127.35	-149.29
2300.0	-78.46	-81.62	-98.66	-126.87	-149.48

FREQUENCY (MHz)	PHASE NOISE (dBc/Hz) @ OFFSETS				
	+85°C				
	100Hz	1kHz	10kHz	100kHz	1MHz
2100.0	-80.45	-81.29	-96.63	-123.76	-143.64
2120.0	-80.14	-82.69	-96.61	-124.52	-145.37
2140.0	-80.10	-82.37	-96.50	-125.02	-144.89
2160.0	-80.20	-82.61	-96.92	-125.24	-146.36
2180.0	-79.78	-81.91	-96.90	-125.37	-146.18
2200.0	-79.83	-81.55	-96.76	-125.45	-146.62
2220.0	-79.70	-81.24	-96.77	-125.54	-146.50
2240.0	-79.86	-81.22	-96.86	-125.61	-146.57
2260.0	-80.16	-81.13	-97.05	-125.64	-146.92
2280.0	-79.82	-80.07	-97.40	-125.62	-146.99
2300.0	-79.54	-79.11	-97.79	-125.39	-146.64



IF/RF MICROWAVE COMPONENTS • ISO 9001 ISO 14001 AS9100 CERTIFIED RoHS compliant

P.O. Box 350166, Brooklyn, New York 11235-0003 (718) 934-4500 Fax (718) 332-4661



The Design Engineers Search Engine finds the model you need, Instantly • For detailed performance specs & shopping online see



Notes: 1. Performance and quality attributes and conditions not expressly stated in this specification sheet are intended to be excluded and do not form a part of this specification sheet. 2. Electrical specifications and performance data contained herein are based on Mini-Circuit's applicable established test performance criteria and measurement instructions. 3. The parts covered by this specification sheet are subject to Mini-Circuits standard limited warranty and terms and conditions (collectively, "Standard Terms"); Purchasers of this part are entitled to the rights and benefits contained therein. For a full statement of the Standard Terms and the exclusive rights and remedies thereunder, please visit Mini-Circuits' website at www.minicircuits.com/MCLStore/terms.jsp.

COMPARISON SPURIOUS ORDER	COMPARISON SPURIOUS @Fcarrier 2100MHz+(n*Fcomparison) (dBc) note 1			COMPARISON SPURIOUS @Fcarrier 2200MHz+(n*Fcomparison) (dBc) note 1			COMPARISON SPURIOUS @Fcarrier 2300MHz+(n*Fcomparison) (dBc) note 1		
	n			n			n		
	-45°C	+25°C	+85°C	-45°C	+25°C	+85°C	-45°C	+25°C	+85°C
-5	-114.53	-110.96	-121.70	-121.31	-111.99	-115.27	-119.58	-114.12	-120.81
-4	-119.79	-109.34	-116.78	-116.94	-111.60	-116.19	-114.94	-112.30	-118.45
-3	-112.71	-108.57	-117.33	-116.74	-109.37	-114.20	-109.45	-112.17	-115.94
-2	-107.12	-103.78	-111.91	-111.00	-104.61	-111.90	-109.93	-110.20	-108.32
-1	-93.31	-98.60	-98.32	-96.00	-98.78	-99.10	-93.66	-100.05	-99.99
0 note 2	-	-	-	-	-	-	-	-	-
+1	-97.46	-98.24	-99.71	-93.97	-98.04	-99.98	-94.79	-100.75	-97.82
+2	-107.99	-102.82	-111.11	-110.06	-105.10	-112.24	-110.58	-108.84	-112.59
+3	-111.50	-106.84	-115.40	-114.44	-105.64	-113.66	-111.99	-112.18	-113.32
+4	-117.23	-107.86	-117.88	-116.25	-109.09	-110.29	-111.52	-112.37	-118.26
+5	-119.03	-111.03	-118.08	-120.81	-112.63	-114.14	-115.29	-115.72	-123.05

Note 1: Comparison frequency 200 kHz
 Note 2: All spurs are referenced to carrier signal (n=0).

REFERENCE SPURIOUS ORDER	REFERENCE SPURIOUS @Fcarrier 2100MHz+(n*Freference) (dBc) note 3			REFERENCE SPURIOUS @Fcarrier 2200MHz+(n*Freference) (dBc) note 3			REFERENCE SPURIOUS @Fcarrier 2300MHz+(n*Freference) (dBc) note 3		
	n			n			n		
	-45°C	+25°C	+85°C	-45°C	+25°C	+85°C	-45°C	+25°C	+85°C
-5	-110.65	-113.60	-116.68	-118.23	-125.04	-128.43	-113.09	-118.44	-121.69
-4	-103.64	-109.54	-110.40	-101.34	-105.47	-108.04	-95.75	-98.31	-100.93
-3	-107.50	-112.18	-117.05	-102.26	-105.73	-109.71	-83.37	-89.57	-95.77
-2	-82.56	-87.69	-91.46	-100.44	-104.09	-107.10	-102.94	-106.26	-109.12
-1	-113.44	-116.31	-109.34	-103.23	-107.24	-108.75	-111.85	-104.02	-99.48
0 note 4	-	-	-	-	-	-	-	-	-
+1	-91.19	-92.18	-91.48	-98.60	-100.93	-105.65	-93.73	-95.18	-95.69
+2	-82.76	-88.27	-91.94	-97.50	-101.49	-103.04	-103.35	-107.35	-110.20
+3	-105.46	-109.11	-111.99	-97.99	-102.40	-106.01	-83.02	-89.73	-96.06
+4	-100.07	-103.90	-106.76	-98.11	-101.54	-104.32	-94.35	-97.55	-100.27
+5	-108.09	-114.58	-121.14	-118.03	-120.83	-123.64	-110.91	-117.90	-121.05

Note 3: Reference frequency 76.8 MHz
 Note 4: All spurs are referenced to carrier signal (n=0).



IF/RF MICROWAVE COMPONENTS • ISO 9001 ISO 14001 AS9100 CERTIFIED RoHS compliant
 P.O. Box 350166, Brooklyn, New York 11235-0003 (718) 934-4500 Fax (718) 332-4661



The Design Engineers Search Engine finds the model you need, Instantly • For detailed performance specs & shopping online see



Notes: 1. Performance and quality attributes and conditions not expressly stated in this specification sheet are intended to be excluded and do not form a part of this specification sheet. 2. Electrical specifications and performance data contained herein are based on Mini-Circuit's applicable established test performance criteria and measurement instructions. 3. The parts covered by this specification sheet are subject to Mini-Circuits standard limited warranty and terms and conditions (collectively, "Standard Terms"); Purchasers of this part are entitled to the rights and benefits contained therein. For a full statement of the Standard Terms and the exclusive rights and remedies thereunder, please visit Mini-Circuits' website at www.minicircuits.com/MCLStore/terms.jsp.

Typical Performance Curves

OUTPUT POWER Vs FREQUENCY

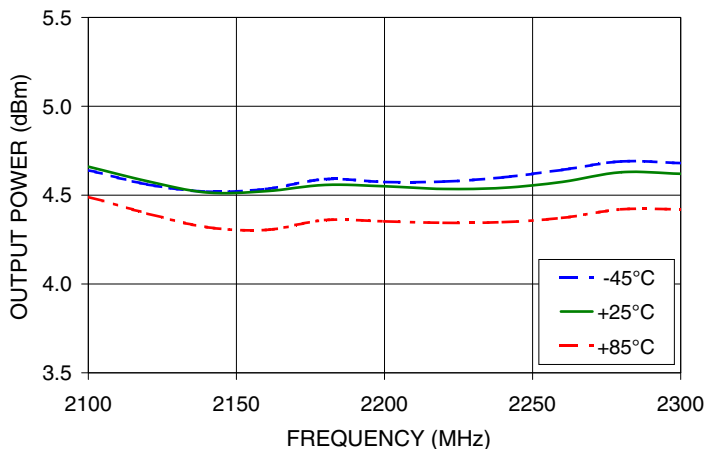

2nd HARMONIC Vs FREQUENCY

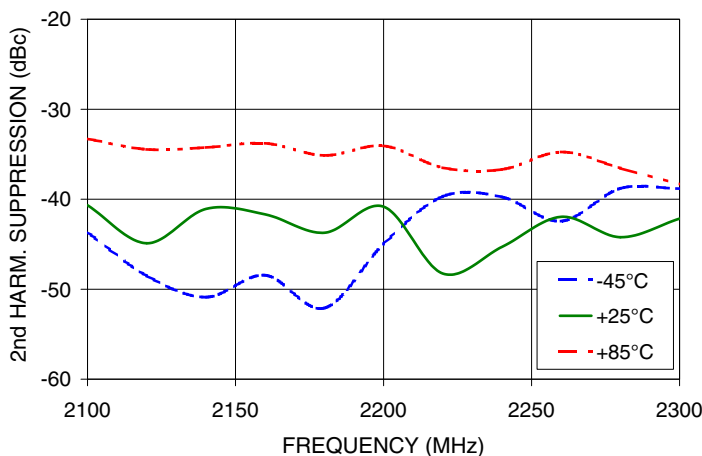

3rd HARMONIC Vs FREQUENCY

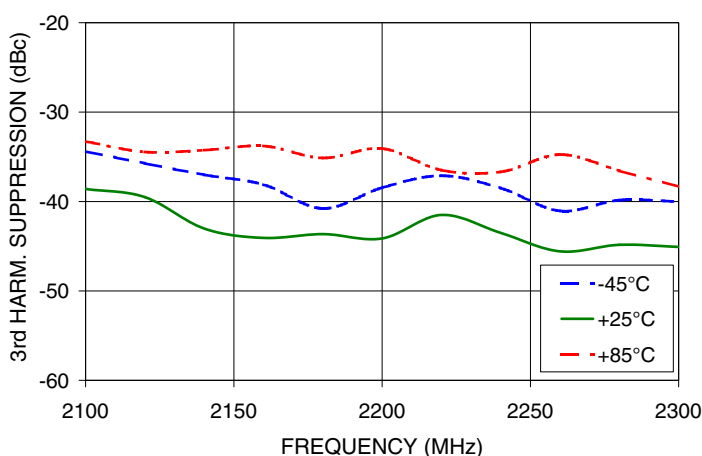

IF/RF MICROWAVE COMPONENTS • ISO 9001 ISO 14001 AS9100 CERTIFIED RoHS compliant
 P.O. Box 350166, Brooklyn, New York 11235-0003 (718) 934-4500 Fax (718) 332-4661



The Design Engineers Search Engine finds the model you need, Instantly • For detailed performance specs & shopping online see



Notes: 1. Performance and quality attributes and conditions not expressly stated in this specification sheet are intended to be excluded and do not form a part of this specification sheet. 2. Electrical specifications and performance data contained herein are based on Mini-Circuit's applicable established test performance criteria and measurement instructions. 3. The parts covered by this specification sheet are subject to Mini-Circuits standard limited warranty and terms and conditions (collectively, "Standard Terms"); Purchasers of this part are entitled to the rights and benefits contained therein. For a full statement of the Standard Terms and the exclusive rights and remedies thereunder, please visit Mini-Circuits' website at www.minicircuits.com/MCLStore/terms.jsp.

PHASE NOISE @100Hz offset

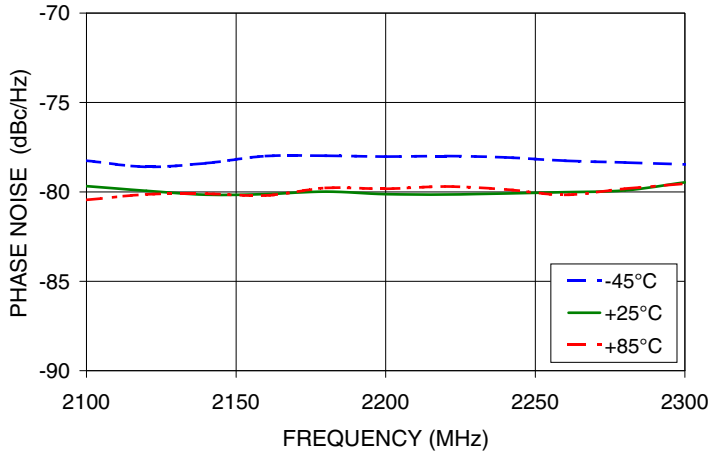

PHASE NOISE @1kHz offset

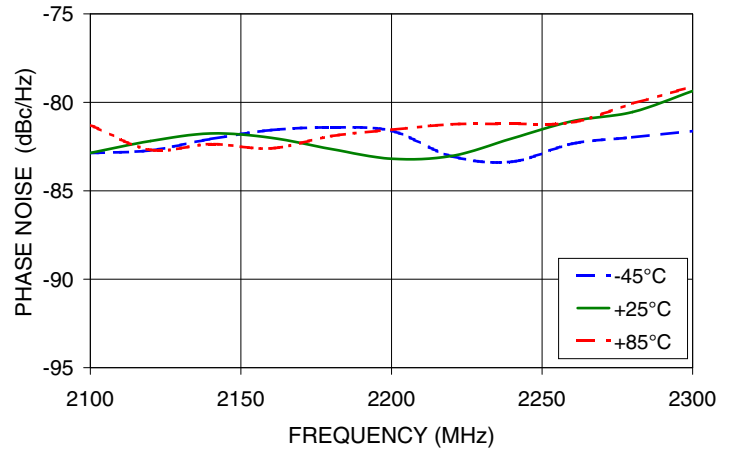

PHASE NOISE @10kHz offset

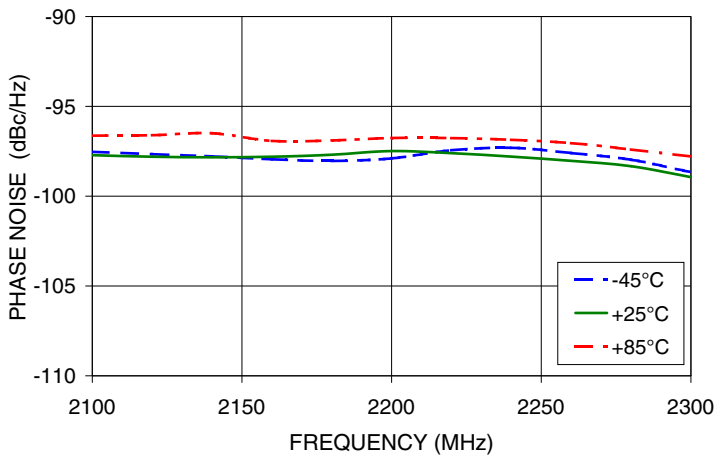

PHASE NOISE @100kHz offset

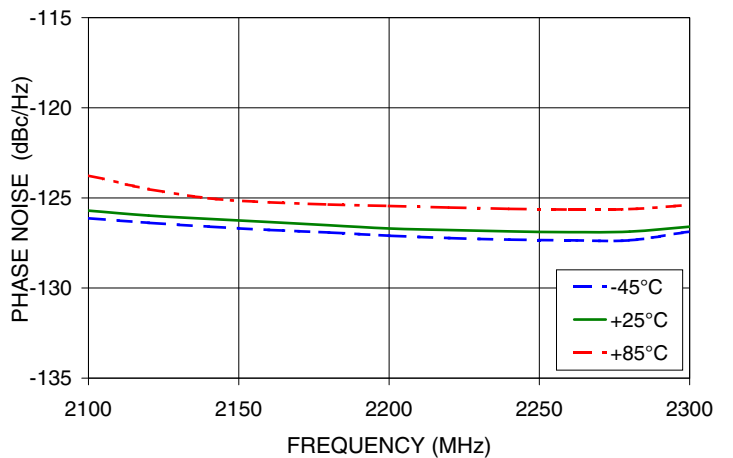

PHASE NOISE @1MHz offset

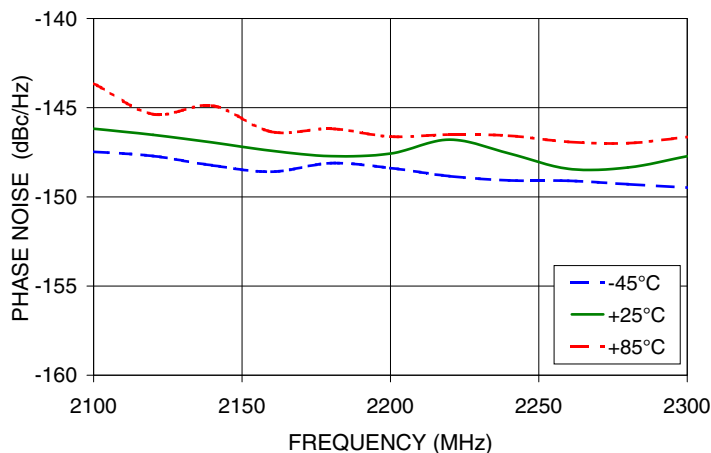

IF/RF MICROWAVE COMPONENTS • ISO 9001 ISO 14001 AS9100 CERTIFIED RoHS compliant
 P.O. Box 350166, Brooklyn, New York 11235-0003 (718) 934-4500 Fax (718) 332-4661



The Design Engineers Search Engine finds the model you need, Instantly • For detailed performance specs & shopping online see



Notes: 1. Performance and quality attributes and conditions not expressly stated in this specification sheet are intended to be excluded and do not form a part of this specification sheet. 2. Electrical specifications and performance data contained herein are based on Mini-Circuit's applicable established test performance criteria and measurement instructions. 3. The parts covered by this specification sheet are subject to Mini-Circuits standard limited warranty and terms and conditions (collectively, "Standard Terms"); Purchasers of this part are entitled to the rights and benefits contained therein. For a full statement of the Standard Terms and the exclusive rights and remedies thereunder, please visit Mini-Circuits' website at www.minicircuits.com/MCLStore/terms.jsp.

COMPARISON SPURIOUS
Vs FREQ. OFFSET @ Fcar = 2100MHz

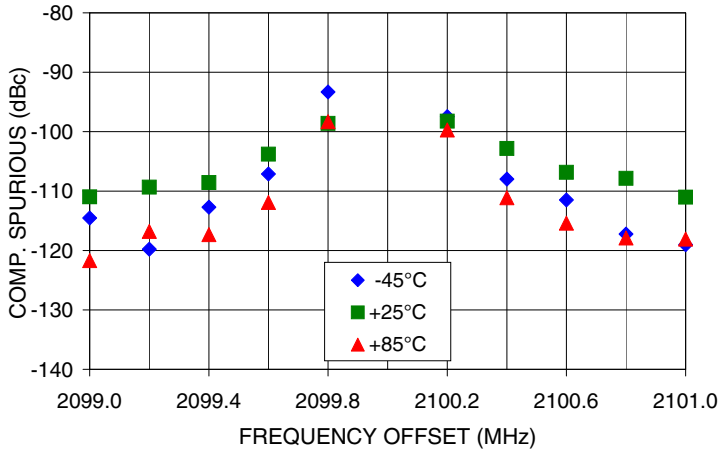

REFERENCE SPURIOUS
Vs FREQ. OFFSET @ Fcar = 2100MHz

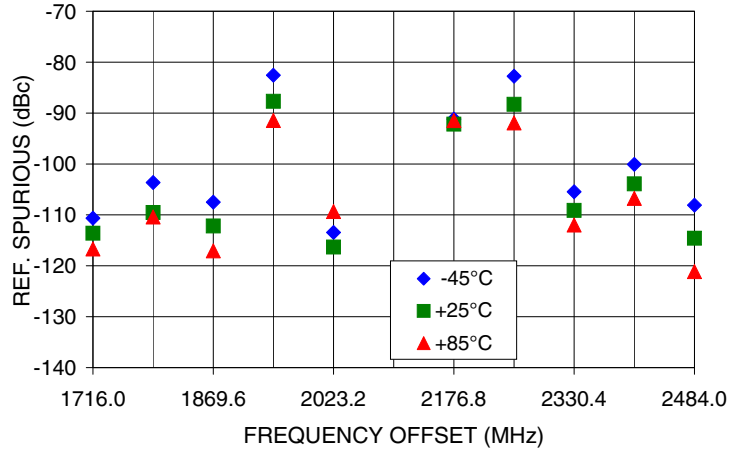

COMPARISON SPURIOUS
Vs FREQ. OFFSET @ Fcar = 2200MHz

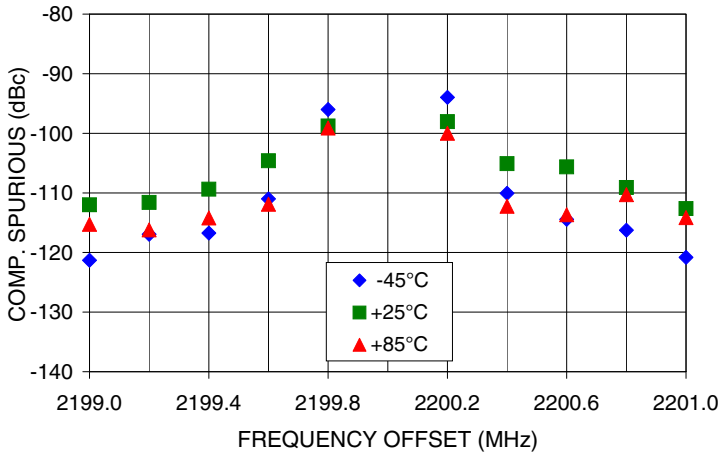

REFERENCE SPURIOUS
Vs FREQ. OFFSET @ Fcar = 2200MHz

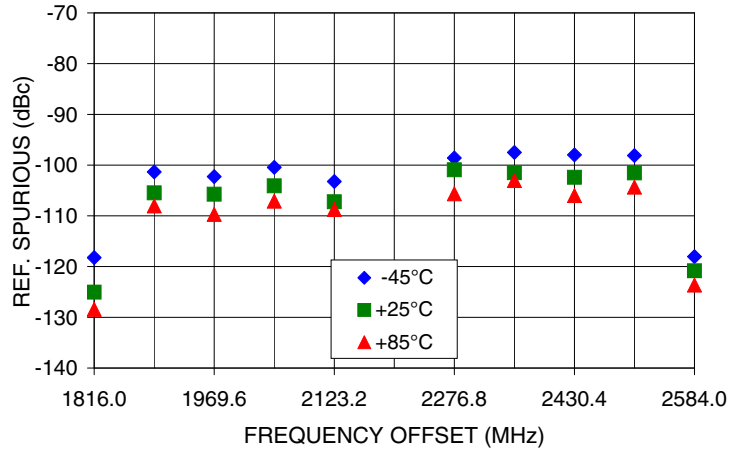

COMPARISON SPURIOUS
Vs FREQ. OFFSET @ Fcar = 2300MHz

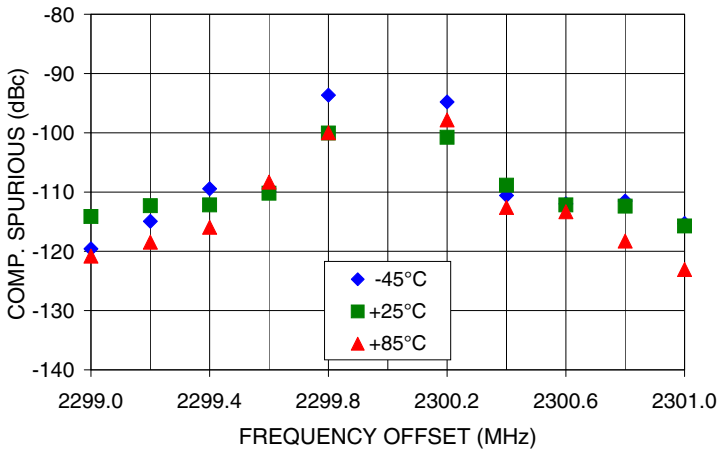

REFERENCE SPURIOUS
Vs FREQ. OFFSET @ Fcar = 2300MHz

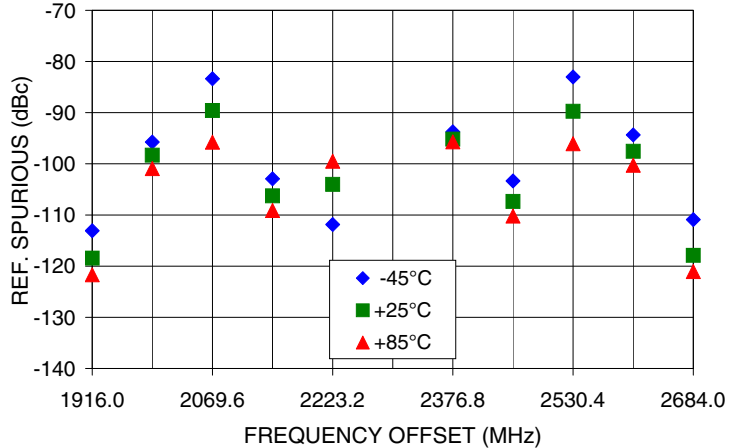

IF/RF MICROWAVE COMPONENTS • ISO 9001 ISO 14001 AS 9100 CERTIFIED RoHS compliant
P.O. Box 350166, Brooklyn, New York 11235-0003 (718) 934-4500 Fax (718) 332-4661



The Design Engineers Search Engine finds the model you need, Instantly • For detailed performance specs & shopping online see



Notes: 1. Performance and quality attributes and conditions not expressly stated in this specification sheet are intended to be excluded and do not form a part of this specification sheet. 2. Electrical specifications and performance data contained herein are based on Mini-Circuit's applicable established test performance criteria and measurement instructions. 3. The parts covered by this specification sheet are subject to Mini-Circuits standard limited warranty and terms and conditions (collectively, "Standard Terms"); Purchasers of this part are entitled to the rights and benefits contained therein. For a full statement of the Standard Terms and the exclusive rights and remedies thereunder, please visit Mini-Circuits' website at www.minicircuits.com/MCLStore/terms.jsp.

Pin Configuration

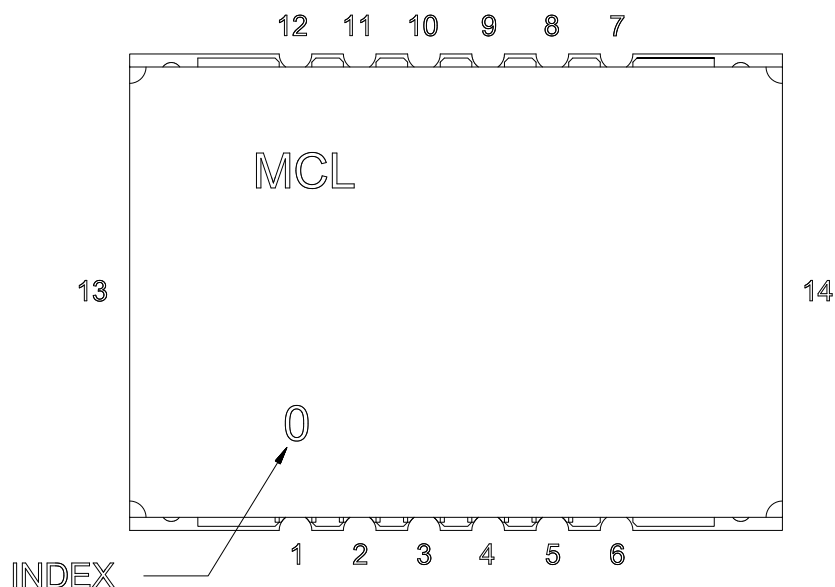

Pin Connection

Pin Number	Function
1	VCC PLL
2	GND
3	REF IN
4	GND
5	VCC VCO
6	GND
7	RF OUT
8	GND
9	LOCK DET
10	CLOCK
11	DATA
12	LE
13	GND
14	GND

Recommended Application Circuit

Note: REF IN and RF OUT ports are internally AC coupled.

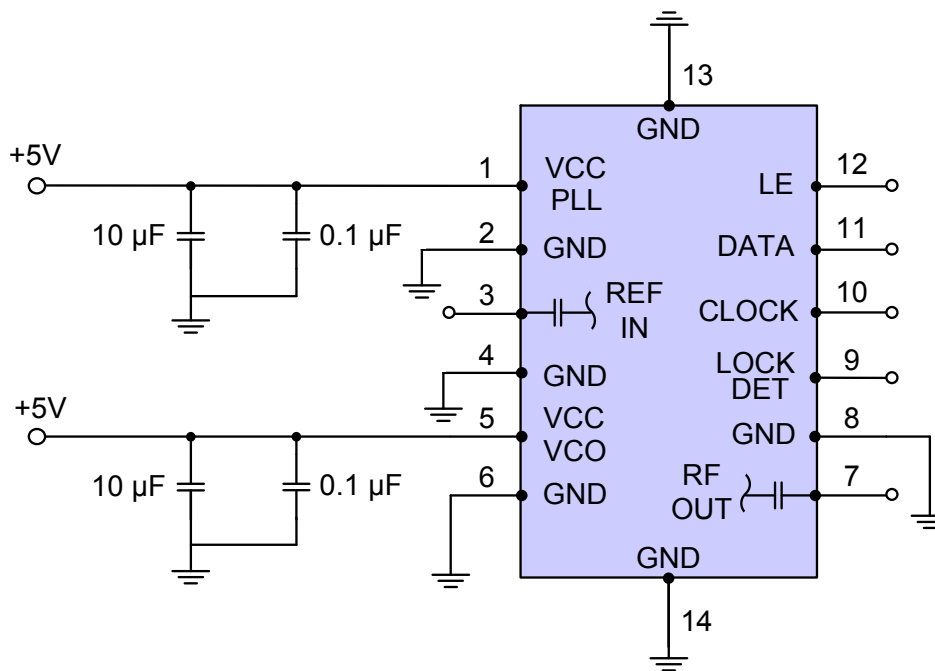

IF/RF MICROWAVE COMPONENTS • ISO 9001 ISO 14001 AS9100 CERTIFIED RoHS compliant
 P.O. Box 350166, Brooklyn, New York 11235-0003 (718) 934-4500 Fax (718) 332-4661



The Design Engineers Search Engine finds the model you need, Instantly • For detailed performance specs & shopping online see



Notes: 1. Performance and quality attributes and conditions not expressly stated in this specification sheet are intended to be excluded and do not form a part of this specification sheet. 2. Electrical specifications and performance data contained herein are based on Mini-Circuit's applicable established test performance criteria and measurement instructions. 3. The parts covered by this specification sheet are subject to Mini-Circuits standard limited warranty and terms and conditions (collectively, "Standard Terms"); Purchasers of this part are entitled to the rights and benefits contained therein. For a full statement of the Standard Terms and the exclusive rights and remedies thereunder, please visit Mini-Circuits' website at www.minicircuits.com/MCLStore/terms.jsp.

Device Marking

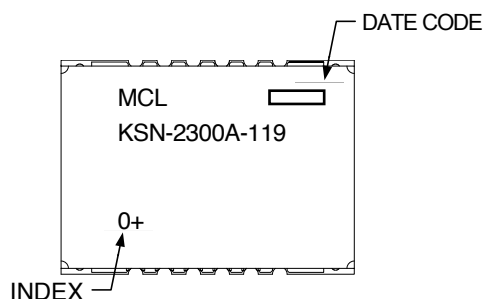
**Additional Detailed Technical Information**

Additional information is available on our web site. To access this information enter the model number on our web site home page.

Case Style: DK1042

Tape & Reel: TR-F28

Suggested Layout for PCB Design: PL-249

Evaluation Board: TB-567+

Environment Ratings: ENV03T2



IF/RF MICROWAVE COMPONENTS • ISO 9001 ISO 14001 AS 9100 CERTIFIED RoHS compliant

P.O. Box 350166, Brooklyn, New York 11235-0003 (718) 934-4500 Fax (718) 332-4661



Patent Pending

The Design Engineers Search Engine finds the model you need, Instantly • For detailed performance specs & shopping online see



Notes: 1. Performance and quality attributes and conditions not expressly stated in this specification sheet are intended to be excluded and do not form a part of this specification sheet. 2. Electrical specifications and performance data contained herein are based on Mini-Circuit's applicable established test performance criteria and measurement instructions. 3. The parts covered by this specification sheet are subject to Mini-Circuits standard limited warranty and terms and conditions (collectively, "Standard Terms"); Purchasers of this part are entitled to the rights and benefits contained therein. For a full statement of the Standard Terms and the exclusive rights and remedies thereunder, please visit Mini-Circuits' website at www.minicircuits.com/MCLStore/terms.jsp.