

Frequency Synthesizer

KSN-2280A-119+

50Ω 2151.76 to 2271.76 MHz

The Big Deal

- Fractional N synthesizer
- Low phase noise and spurious
- Robust design and construction
- Small size 0.80" x 0.58" x 0.15"



CASE STYLE: DK1042

Product Overview

The KSN-2280A-119+ is a Frequency Synthesizer, designed to operate from 2151.76 to 2271.76 MHz for TD-SCDMA application. The KSN-2280A-119+ is packaged in a metal case (size of 0.80" x 0.58" x 0.15") to shield against unwanted signals and noise.

Key Features

Feature	Advantages
Low phase noise and spurious: <ul style="list-style-type: none">• Phase Noise: -97 dBc/Hz typ. @ 10 kHz offset• Step Size Spurious: -78 dBc typ.• Comparison Spurious: -100 dBc typ.• Reference Spurious: -100 dBc typ.	Low phase noise and spurious improve system EVM (Error Vector Magnitude).
Robust design and construction	To enhance the robustness of KSN-2280A-119+, each internal component is secured to the substrate with chip bonder, thereby eliminating the risk of tombstoning during subsequent solder reflow operations by the customer.
Small size, 0.80" x 0.58" x 0.15"	The small size enables the KSN-2280A-119+ to be used in compact designs.



IF/RF MICROWAVE COMPONENTS • ISO 9001 ISO 14001 AS9100 CERTIFIED RoHS compliant
P.O. Box 350166, Brooklyn, New York 11235-0003 (718) 934-4500 Fax (718) 332-4661



The Design Engineers Search Engine finds the model you need, Instantly • For detailed performance specs & shopping online see minicircuits.com

Notes: 1. Performance and quality attributes and conditions not expressly stated in this specification sheet are intended to be excluded and do not form a part of this specification sheet. 2. Electrical specifications and performance data contained herein are based on Mini-Circuit's applicable established test performance criteria and measurement instructions. 3. The parts covered by this specification sheet are subject to Mini-Circuits standard limited warranty and terms and conditions (collectively, "Standard Terms"); Purchasers of this part are entitled to the rights and benefits contained therein. For a full statement of the Standard Terms and the exclusive rights and remedies thereunder, please visit Mini-Circuits' website at www.minicircuits.com/MCLStore/terms.jsp.

Frequency Synthesizer

KSN-2280A-119+

50Ω 2151.76 to 2271.76 MHz

Features

- Fractional N synthesizer
- Integrated VCO + PLL
- Low phase noise and spurious
- Robust design and construction
- Low operating voltage (VCC VCO=+5V, VCC PLL=+5V)
- Small size 0.80" x 0.58" x 0.15"

Applications

- TD-SCDMA

General Description

The KSN-2280A-119+ is a Frequency Synthesizer, designed to operate from 2151.76 to 2271.76 MHz for TD-SCDMA application. The KSN-2280A-119+ is packaged in a metal case (size of 0.80" x 0.58" x 0.15) to shield against unwanted signals and noise. To enhance the robustness of KSN-2280A-119+, each internal component is secured to the substrate with chip bonder, thereby eliminating the risk of tombstoning during subsequent solder reflow operations by the customer.



CASE STYLE: DK1042
PRICE: \$29.95 ea. QTY (1-9)

+ RoHS compliant in accordance with EU Directive (2002/95/EC)

The +Suffix has been added in order to identify RoHS Compliance. See our web site for RoHS Compliance methodologies and qualifications.

Simplified Schematic

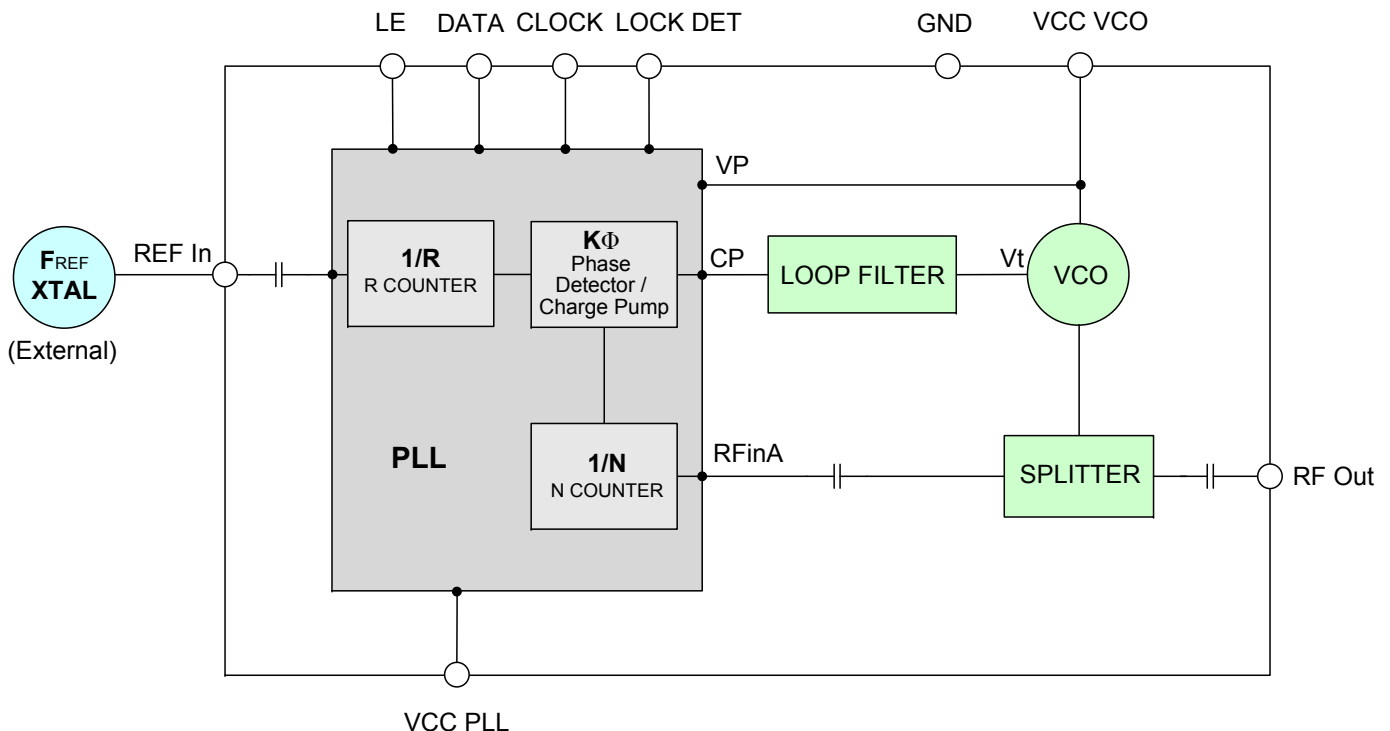

IF/RF MICROWAVE COMPONENTS • ISO 9001 ISO 14001 AS9100 CERTIFIED RoHS compliant
P.O. Box 350166, Brooklyn, New York 11235-0003 (718) 934-4500 Fax (718) 332-4661



The Design Engineers Search Engine finds the model you need, Instantly • For detailed performance specs & shopping online see



Notes: 1. Performance and quality attributes and conditions not expressly stated in this specification sheet are intended to be excluded and do not form a part of this specification sheet. 2. Electrical specifications and performance data contained herein are based on Mini-Circuit's applicable established test performance criteria and measurement instructions. 3. The parts covered by this specification sheet are subject to Mini-Circuits standard limited warranty and terms and conditions (collectively, "Standard Terms"); Purchasers of this part are entitled to the rights and benefits contained therein. For a full statement of the Standard Terms and the exclusive rights and remedies thereunder, please visit Mini-Circuits' website at www.minicircuits.com/MCLStore/terms.jsp.

Electrical Specifications (over operating temperature -40°C to +85°C)

Parameters	Test Conditions	Min.	Typ.	Max.	Units
Frequency Range	-	2151.76	-	2271.76	MHz
Step Size	-	-	20	-	kHz
Comparison Frequency	-	-	15.36	-	MHz
Settling Time	Within ± 1 kHz	-	25	-	mSec
Output Power	-	+2	+5	+7	dBm
SSB Phase Noise	@ 100 Hz offset	-	-75	-	dBc/Hz
	@ 1 kHz offset	-	-82	-75	
	@ 10 kHz offset	-	-97	-89	
	@ 100 kHz offset	-	-127	-122	
	@ 1 MHz offset	-	-148	-142	
Integrated SSB Phase Noise	@ 1 kHz to 5MHz	-	-46	-44	dBc
Step Size Spurious Suppression	Step Size 20 kHz	-	-78	-60	dBc
0.5 Step Size Spurious Suppression	0.5 Step Size 10 kHz	-	-68	-57	
Reference Spurious Suppression	Ref. Freq. 30.72 MHz	-	-100	-75	
Comparison Spurious Suppression	Comp. Freq. 15.36 MHz	-	-100	-77	
Non - Harmonic Spurious Suppression	-	-	-90	-	
Harmonic Suppression	-	-	-36	-22	
VCO Supply Voltage	5.00	4.75	5.00	5.25	V
PLL Supply Voltage	5.00	4.75	5.00	5.25	
VCO Supply Current	-	-	45	51	mA
PLL Supply Current	-	-	39	46	
Reference Input (External)	Frequency	30.72 (square wave)	-	30.72	MHz
	Amplitude	1	-	1	V _{P-P}
	Input impedance	-	-	100	KΩ
	Phase Noise @ 1 kHz offset	-	-	-130	dBc/Hz
RF Output port Impedance	-	-	50	-	Ω
Input Logic Level	Input high voltage	-	2.7	-	V
	Input low voltage	-	-	0.6	V
Digital Lock Detect	Locked	-	2.6	3.4	V
	Unlocked	-	-	0.4	V
Frequency Synthesizer PLL	-	ADF4153			
PLL Programming	-	3-wire serial 3V CMOS			
Register Map @ 2271.76MHz	R0_Register	-	(MSB) 001001001100101011010000 (LSB)		
	R1_Register	-	(MSB) 000101001000110000000001 (LSB)		
	R2_Register	-	(MSB) 0000000111100010 (LSB)		
	R3_Register	-	(MSB) 000000000011 (LSB)		

Absolute Maximum Ratings

Parameters	Ratings
VCO Supply Voltage	5.8V
PLL Supply Voltage	5.8V
VCO Supply Voltage to PLL Supply Voltage	-0.3V to +5.8V
Reference Frequency Voltage	-0.3Vmin, +3.3Vmax
Data, Clock, LE Levels	-0.3Vmin, +3.3Vmax
Operating Temperature	-40°C to +85°C
Storage Temperature	-55°C to +100°C

Permanent damage may occur if any of these limits are exceeded



IF/RF MICROWAVE COMPONENTS • ISO 9001 ISO 14001 AS9100 CERTIFIED RoHS compliant
 P.O. Box 350166, Brooklyn, New York 11235-0003 (718) 934-4500 Fax (718) 332-4661

The Design Engineers Search Engine finds the model you need, Instantly • For detailed performance specs & shopping online see minicircuits.com

Notes: 1. Performance and quality attributes and conditions not expressly stated in this specification sheet are intended to be excluded and do not form a part of this specification sheet. 2. Electrical specifications and performance data contained herein are based on Mini-Circuit's applicable established test performance criteria and measurement instructions. 3. The parts covered by this specification sheet are subject to Mini-Circuits standard limited warranty and terms and conditions (collectively, "Standard Terms"); Purchasers of this part are entitled to the rights and benefits contained therein. For a full statement of the Standard Terms and the exclusive rights and remedies thereunder, please visit Mini-Circuits' website at www.minicircuits.com/MCLStore/terms.jsp.

Typical Performance Data

FREQUENCY (MHz)	POWER OUTPUT (dBm)			VCO CURRENT (mA)			PLL CURENT (mA)		
	-45°C	+25°C	+85°C	-45°C	+25°C	+85°C	-45°C	+25°C	+85°C
	2151.76	4.99	5.11	4.97	42.55	44.53	45.62	37.35	38.65
2169.00	5.08	5.17	5.02	42.59	44.58	45.66	37.44	38.76	40.23
2192.00	5.18	5.26	5.11	42.67	44.65	45.72	37.43	38.75	40.22
2215.00	5.18	5.25	5.12	42.77	44.73	45.79	37.45	38.77	40.25
2238.00	5.01	5.08	4.92	42.84	44.80	45.86	37.48	38.82	40.30
2261.00	5.02	5.06	4.84	42.90	44.86	45.92	37.46	38.79	40.27
2271.76	5.08	5.11	4.89	42.93	44.89	45.95	37.40	38.75	40.22

FREQUENCY (MHz)	HARMONICS (dBc)					
	F2			F3		
	-45°C	+25°C	+85°C	-45°C	+25°C	+85°C
2151.76	-35.05	-42.43	-38.35	-33.21	-35.43	-38.00
2169.00	-32.06	-40.48	-38.69	-33.97	-36.87	-39.59
2192.00	-31.73	-38.34	-40.39	-33.92	-36.09	-38.34
2215.00	-31.82	-40.76	-38.28	-33.03	-37.32	-40.88
2238.00	-28.76	-34.28	-41.34	-33.20	-36.51	-38.99
2261.00	-32.48	-37.85	-37.96	-37.07	-39.98	-42.13
2271.76	-32.27	-38.08	-36.81	-39.59	-43.57	-45.22

FREQUENCY (MHz)	PHASE NOISE (dBc/Hz) @OFFSETS				
	+25°C				
	100Hz	1kHz	10kHz	100kHz	1MHz
2151.76	-77.31	-83.26	-96.72	-126.59	-146.74
2169.00	-77.39	-83.14	-98.44	-126.69	-147.26
2192.00	-76.14	-83.15	-98.02	-127.00	-147.69
2215.00	-76.22	-84.18	-97.27	-127.25	-147.59
2238.00	-73.89	-82.66	-97.29	-127.52	-147.86
2261.00	-76.24	-82.94	-97.01	-127.55	-148.00
2271.76	-74.47	-82.08	-96.65	-127.54	-148.05

FREQUENCY (MHz)	PHASE NOISE (dBc/Hz) @OFFSETS				
	-45°C				
	100Hz	1kHz	10kHz	100kHz	1MHz
2151.76	-74.14	-84.72	-95.37	-127.11	-147.55
2169.00	-77.14	-83.22	-95.99	-127.50	-147.89
2192.00	-76.43	-82.71	-95.50	-127.83	-148.29
2215.00	-75.10	-85.97	-94.68	-128.11	-148.60
2238.00	-76.71	-84.42	-94.72	-128.33	-149.14
2261.00	-75.62	-83.02	-94.19	-128.16	-149.28
2271.76	-76.53	-84.48	-93.43	-128.04	-149.06

FREQUENCY (MHz)	PHASE NOISE (dBc/Hz) @OFFSETS				
	+85°C				
	100Hz	1kHz	10kHz	100kHz	1MHz
2151.76	-80.21	-83.54	-95.90	-125.37	-145.77
2169.00	-79.37	-83.58	-97.85	-125.69	-146.17
2192.00	-78.66	-83.84	-97.65	-126.02	-146.28
2215.00	-80.24	-85.06	-96.56	-126.27	-146.68
2238.00	-78.26	-82.99	-96.36	-126.40	-146.99
2261.00	-81.55	-83.32	-96.00	-126.47	-146.96
2271.76	-77.84	-83.50	-95.50	-126.48	-147.04



IF/RF MICROWAVE COMPONENTS • ISO 9001 ISO 14001 AS9100 CERTIFIED RoHS compliant
 P.O. Box 350166, Brooklyn, New York 11235-0003 (718) 934-4500 Fax (718) 332-4661



The Design Engineers Search Engine finds the model you need, Instantly • For detailed performance specs & shopping online see



Notes: 1. Performance and quality attributes and conditions not expressly stated in this specification sheet are intended to be excluded and do not form a part of this specification sheet. 2. Electrical specifications and performance data contained herein are based on Mini-Circuit's applicable established test performance criteria and measurement instructions. 3. The parts covered by this specification sheet are subject to Mini-Circuits standard limited warranty and terms and conditions (collectively, "Standard Terms"); Purchasers of this part are entitled to the rights and benefits contained therein. For a full statement of the Standard Terms and the exclusive rights and remedies thereunder, please visit Mini-Circuits' website at www.minicircuits.com/MCLStore/terms.jsp.

COMPARISON SPURIOUS ORDER	COMPARISON SPURIOUS @Fcarrier 2151.76MHz+(n*Fcomparison) (dBc) note 1			COMPARISON SPURIOUS @Fcarrier 2211.76MHz+(n*Fcomparison) (dBc) note 1			COMPARISON SPURIOUS @Fcarrier 2271.76MHz+(n*Fcomparison) (dBc) note 1			
	n	-45°C	+25°C	+85°C	-45°C	+25°C	+85°C	-45°C	+25°C	+85°C
	-5	-100.66	-99.94	-109.31	-116.98	-112.22	-107.86	-106.68	-101.27	-111.65
-4	-102.88	-99.01	-100.48	-103.21	-103.07	-100.54	-99.38	-102.41	-100.67	
-3	-112.02	-109.80	-105.30	-109.08	-113.42	-104.96	-103.42	-108.05	-105.77	
-2	-103.57	-104.06	-101.37	-100.22	-102.80	-100.98	-99.16	-104.79	-99.04	
-1	-102.32	-99.24	-98.58	-98.79	-99.90	-101.25	-98.57	-99.28	-97.88	
0 note 2	-	-	-	-	-	-	-	-	-	
+1	-97.32	-95.15	-102.19	-101.55	-101.18	-101.43	-101.62	-103.65	-98.09	
+2	-93.27	-92.60	-94.48	-95.38	-95.12	-95.01	-95.55	-97.82	-93.66	
+3	-102.14	-105.67	-102.38	-104.73	-99.44	-105.79	-106.97	-106.32	-104.36	
+4	-105.66	-107.73	-103.84	-103.59	-102.00	-102.93	-108.80	-110.30	-101.24	
+5	-116.25	-108.10	-112.91	-115.19	-109.00	-113.28	-117.72	-106.22	-108.16	

Note 1: Comparison frequency 15.36 MHz
 Note 2: All spurs are referenced to carrier signal (n=0).

REFERENCE SPURIOUS ORDER	REFERENCE SPURIOUS @Fcarrier 2151.76MHz+(n*Freference) (dBc) note 3			REFERENCE SPURIOUS @Fcarrier 2211.76MHz+(n*Freference) (dBc) note 3			REFERENCE SPURIOUS @Fcarrier 2271.76MHz+(n*Freference) (dBc) note 3			
	n	-45°C	+25°C	+85°C	-45°C	+25°C	+85°C	-45°C	+25°C	+85°C
	-5	-93.32	-96.98	-95.61	-94.96	-97.55	-103.09	-94.17	-94.71	-100.26
-4	-94.69	-95.61	-100.04	-95.54	-98.08	-97.05	-93.87	-96.36	-94.93	
-3	-107.10	-101.35	-110.49	-107.00	-113.97	-129.19	-102.95	-99.32	-108.43	
-2	-103.02	-100.64	-99.79	-103.35	-102.92	-100.08	-99.46	-102.47	-100.81	
-1	-103.65	-106.85	-103.40	-100.14	-103.41	-99.57	-98.86	-104.49	-97.84	
0 note 4	-	-	-	-	-	-	-	-	-	
+1	-93.23	-93.71	-93.49	-95.31	-95.14	-94.06	-95.57	-97.73	-93.49	
+2	-106.23	-110.28	-104.29	-103.79	-102.08	-102.45	-108.62	-109.86	-101.58	
+3	-116.18	-114.92	-107.61	-113.14	-110.63	-116.31	-115.32	-106.51	-108.96	
+4	-98.33	-97.51	-107.70	-101.23	-106.38	-105.00	-100.52	-103.17	-101.12	
+5	-94.01	-101.07	-101.51	-100.30	-101.66	-112.54	-102.64	-105.39	-103.54	

Note 3: Reference frequency 30.72 MHz
 Note 4: All spurs are referenced to carrier signal (n=0).



IF/RF MICROWAVE COMPONENTS • ISO 9001 ISO 14001 AS9100 CERTIFIED RoHS compliant
 P.O. Box 350166, Brooklyn, New York 11235-0003 (718) 934-4500 Fax (718) 332-4661



The Design Engineers Search Engine finds the model you need, Instantly • For detailed performance specs & shopping online see



Notes: 1. Performance and quality attributes and conditions not expressly stated in this specification sheet are intended to be excluded and do not form a part of this specification sheet. 2. Electrical specifications and performance data contained herein are based on Mini-Circuit's applicable established test performance criteria and measurement instructions. 3. The parts covered by this specification sheet are subject to Mini-Circuits standard limited warranty and terms and conditions (collectively, "Standard Terms"); Purchasers of this part are entitled to the rights and benefits contained therein. For a full statement of the Standard Terms and the exclusive rights and remedies thereunder, please visit Mini-Circuits' website at www.minicircuits.com/MCLStore/terms.jsp.

STEP SIZE SPURIOUS ORDER n	0.5 STEP SIZE & STEP SIZE SPURIOUS @Fcarrier 2151.76MHz+(n*Fstep size) (dBc) note 5			0.5 STEP SIZE & STEP SIZE SPURIOUS @Fcarrier 2211.76MHz+(n*Fstep size) (dBc) note 5			0.5 STEP SIZE & STEP SIZE SPURIOUS @Fcarrier 2271.76MHz+(n*Fstep size) (dBc) note 5		
	-45°C	+25°C	+85°C	-45°C	+25°C	+85°C	-45°C	+25°C	+85°C
-5.0	-85.23	-86.64	-86.43	-88.52	-84.17	-83.66	-84.46	-87.90	-83.31
-4.5	-84.08	-85.53	-85.35	-85.42	-85.17	-84.98	-85.30	-83.89	-83.08
-4.0	-86.90	-85.31	-83.36	-69.94	-68.48	-67.62	-81.46	-84.51	-86.31
-3.5	-84.82	-84.34	-84.87	-82.08	-84.62	-82.76	-82.33	-82.61	-81.34
-3.0	-84.87	-86.36	-86.49	-83.75	-87.15	-83.80	-84.30	-88.81	-87.12
-2.5	-84.63	-85.66	-83.15	-84.50	-85.18	-86.72	-82.43	-85.82	-86.47
-2.0	-85.01	-85.26	-82.28	-85.70	-84.06	-87.02	-87.20	-80.64	-83.25
-1.5	-82.11	-82.08	-81.58	-77.89	-82.19	-80.66	-80.07	-83.86	-84.84
-1.0	-78.78	-79.85	-79.88	-77.35	-82.27	-79.40	-69.73	-72.51	-70.99
-0.5	-68.53	-68.23	-70.89	-68.41	-70.07	-69.53	-66.25	-65.61	-65.10
0 note 6	-	-	-	-	-	-	-	-	-
+0.5	-68.89	-70.73	-69.19	-67.52	-70.40	-68.89	-65.61	-66.18	-64.34
+1.0	-76.85	-81.89	-78.70	-78.46	-82.76	-81.27	-68.68	-71.10	-70.81
+1.5	-81.71	-84.61	-81.50	-76.71	-82.67	-82.37	-78.84	-81.06	-81.21
+2.0	-83.11	-87.05	-83.31	-87.82	-87.91	-81.63	-87.41	-85.11	-84.01
+2.5	-83.22	-87.52	-84.46	-84.76	-87.10	-86.89	-84.34	-86.21	-81.14
+3.0	-82.10	-82.96	-84.95	-85.38	-84.61	-84.26	-82.58	-87.83	-81.87
+3.5	-81.54	-86.04	-86.89	-81.93	-85.75	-86.57	-85.20	-85.22	-85.06
+4.0	-86.16	-84.03	-86.89	-69.93	-68.81	-67.62	-84.35	-87.22	-85.78
+4.5	-86.94	-82.92	-81.44	-85.55	-87.13	-86.43	-85.14	-84.57	-83.65
+5.0	-87.54	-83.80	-82.14	-85.61	-86.52	-82.01	-88.84	-86.32	-84.77

Note 5: Step size 20 kHz

Note 6: All spurs are referenced to carrier signal (n=0).



IF/RF MICROWAVE COMPONENTS • ISO 9001 ISO 14001 AS9100 CERTIFIED RoHS compliant
 P.O. Box 350166, Brooklyn, New York 11235-0003 (718) 934-4500 Fax (718) 332-4661



The Design Engineers Search Engine finds the model you need, Instantly • For detailed performance specs & shopping online see



Notes: 1. Performance and quality attributes and conditions not expressly stated in this specification sheet are intended to be excluded and do not form a part of this specification sheet. 2. Electrical specifications and performance data contained herein are based on Mini-Circuit's applicable established test performance criteria and measurement instructions. 3. The parts covered by this specification sheet are subject to Mini-Circuits standard limited warranty and terms and conditions (collectively, "Standard Terms"); Purchasers of this part are entitled to the rights and benefits contained therein. For a full statement of the Standard Terms and the exclusive rights and remedies thereunder, please visit Mini-Circuits' website at www.minicircuits.com/MCLStore/terms.jsp.

Typical Performance Curves

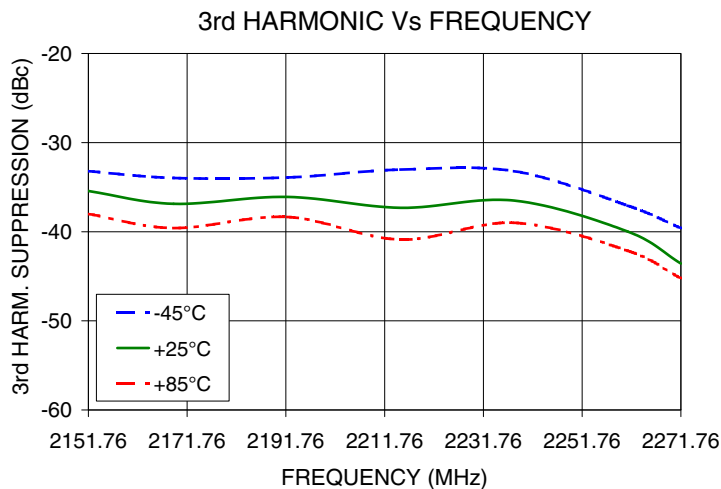
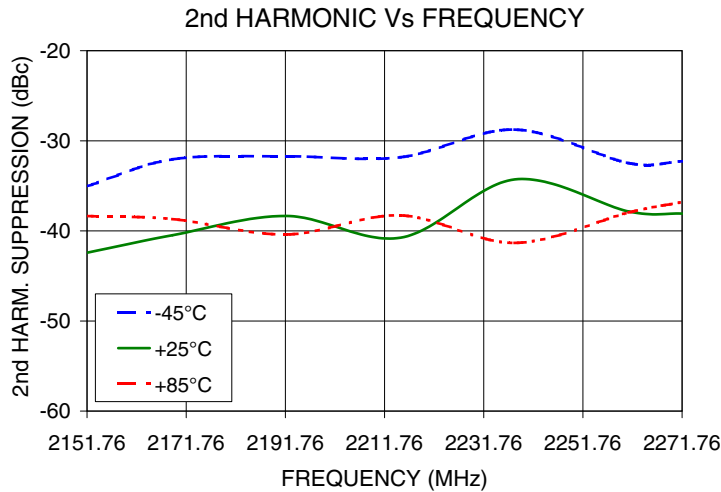
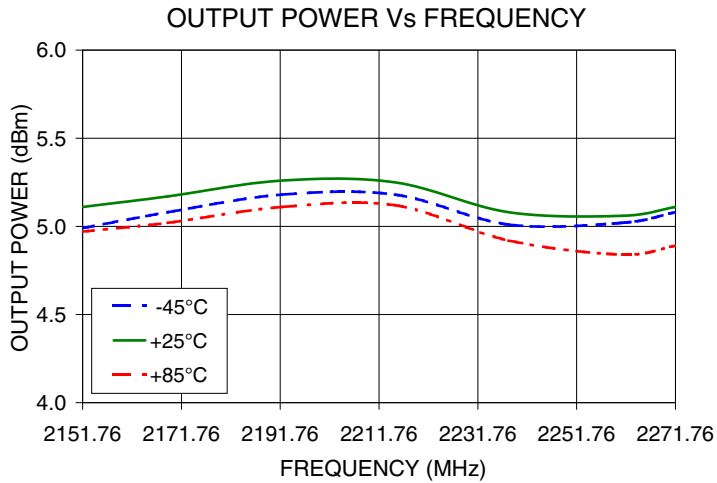

IF/RF MICROWAVE COMPONENTS • ISO 9001 ISO 14001 AS9100 CERTIFIED RoHS compliant
 P.O. Box 350166, Brooklyn, New York 11235-0003 (718) 934-4500 Fax (718) 332-4661



The Design Engineers Search Engine finds the model you need, Instantly • For detailed performance specs & shopping online see



Notes: 1. Performance and quality attributes and conditions not expressly stated in this specification sheet are intended to be excluded and do not form a part of this specification sheet. 2. Electrical specifications and performance data contained herein are based on Mini-Circuit's applicable established test performance criteria and measurement instructions. 3. The parts covered by this specification sheet are subject to Mini-Circuits standard limited warranty and terms and conditions (collectively, "Standard Terms"); Purchasers of this part are entitled to the rights and benefits contained therein. For a full statement of the Standard Terms and the exclusive rights and remedies thereunder, please visit Mini-Circuits' website at www.minicircuits.com/MCLStore/terms.jsp.

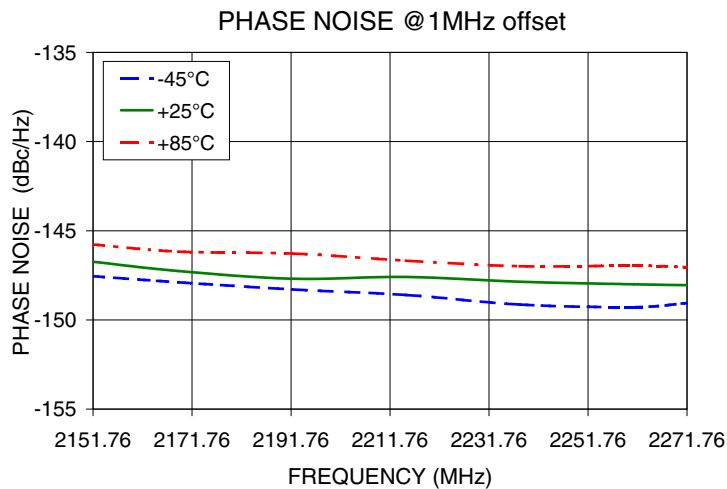
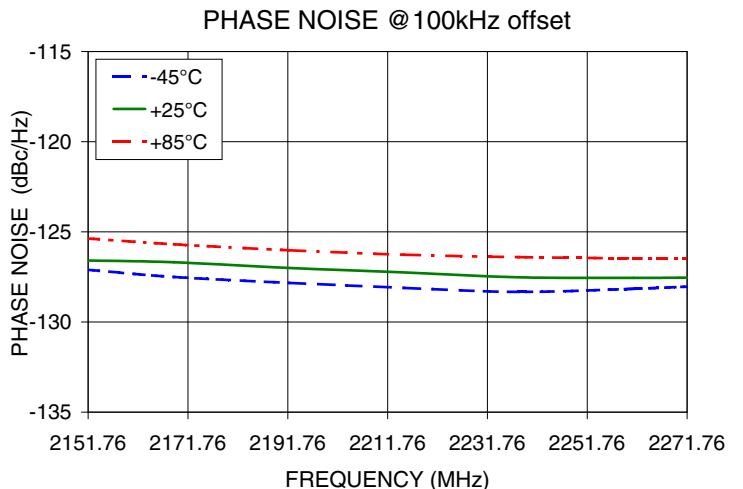
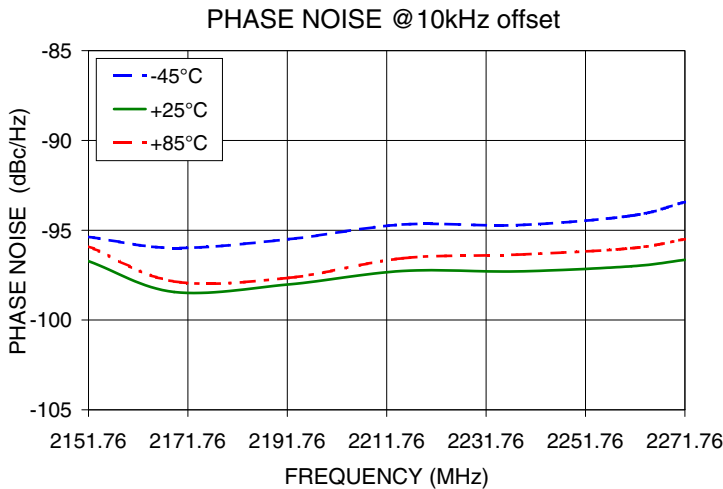
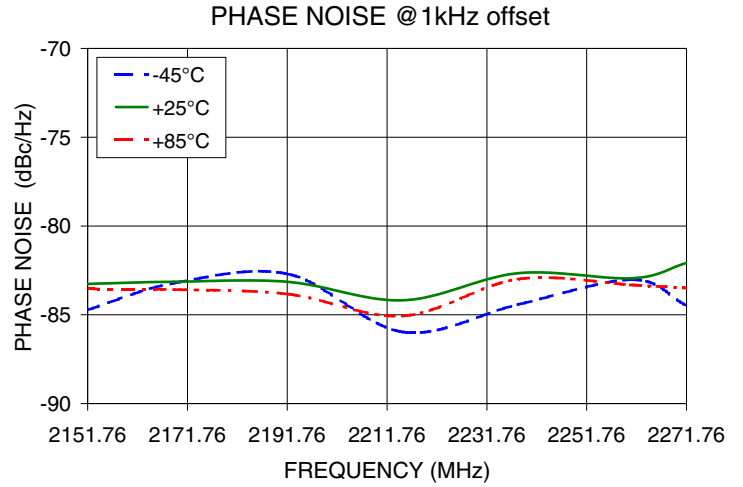
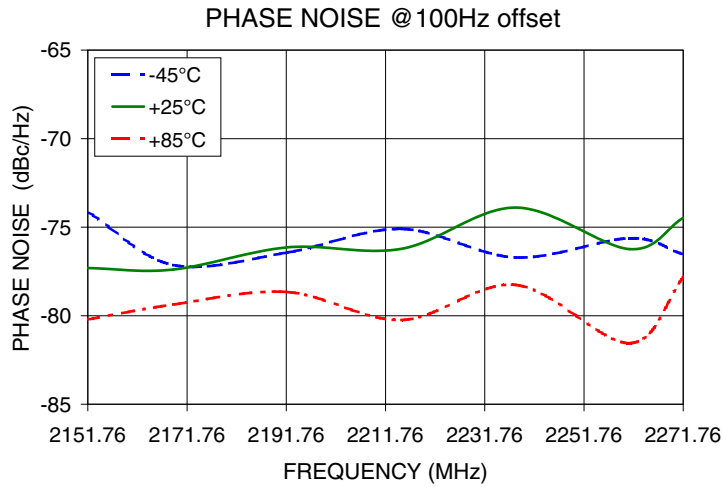

IF/RF MICROWAVE COMPONENTS • ISO 9001 ISO 14001 AS9100 CERTIFIED RoHS compliant
 P.O. Box 350166, Brooklyn, New York 11235-0003 (718) 934-4500 Fax (718) 332-4661



The Design Engineers Search Engine finds the model you need, Instantly • For detailed performance specs & shopping online see



Notes: 1. Performance and quality attributes and conditions not expressly stated in this specification sheet are intended to be excluded and do not form a part of this specification sheet. 2. Electrical specifications and performance data contained herein are based on Mini-Circuit's applicable established test performance criteria and measurement instructions. 3. The parts covered by this specification sheet are subject to Mini-Circuits standard limited warranty and terms and conditions (collectively, "Standard Terms"); Purchasers of this part are entitled to the rights and benefits contained therein. For a full statement of the Standard Terms and the exclusive rights and remedies thereunder, please visit Mini-Circuits' website at www.minicircuits.com/MCLStore/terms.jsp.

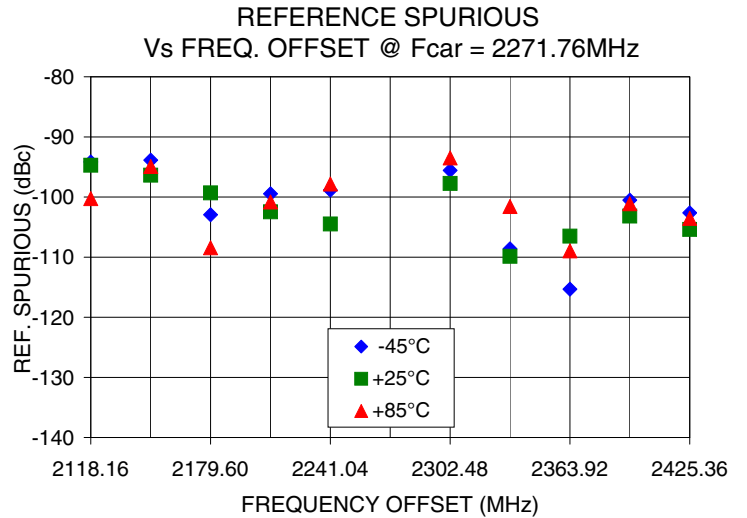
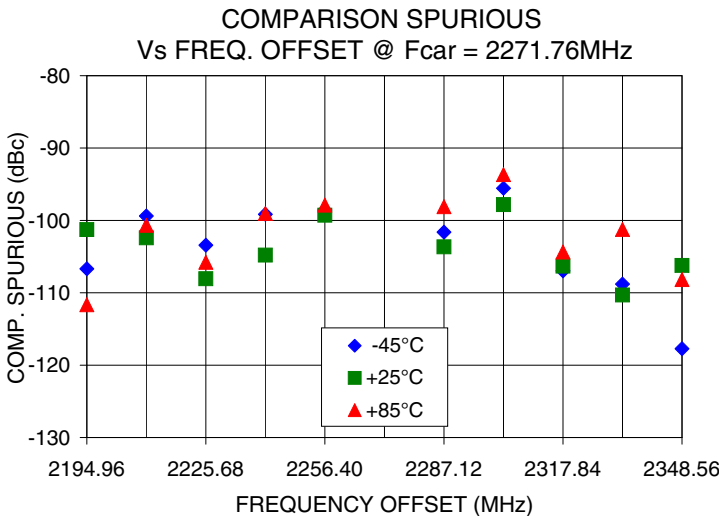
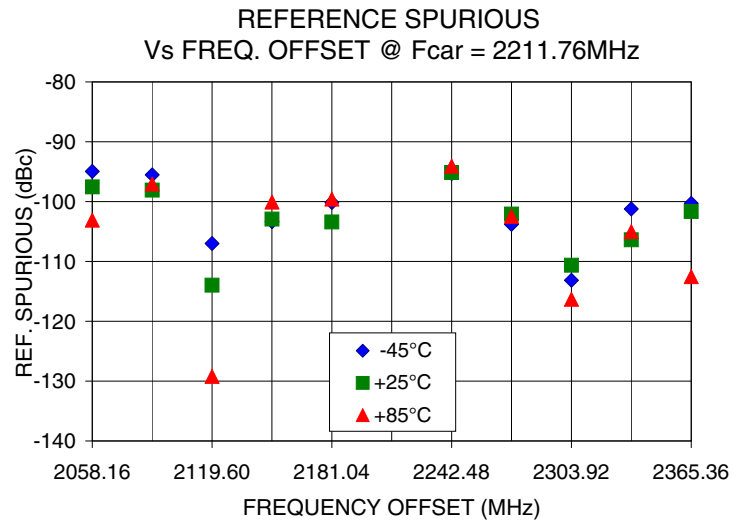
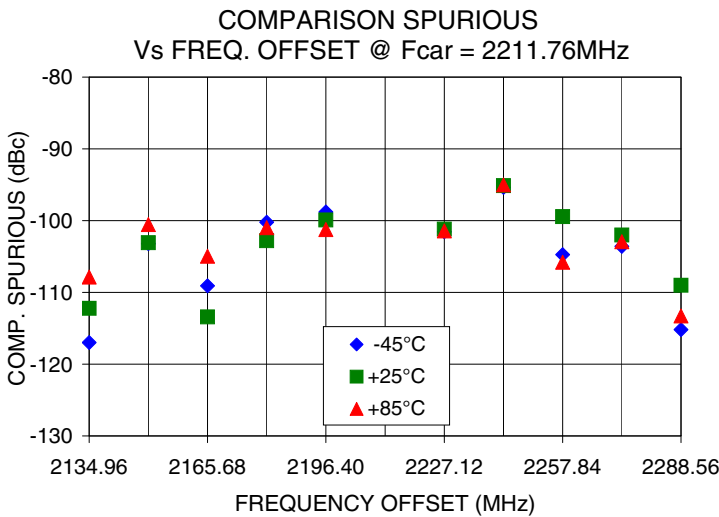
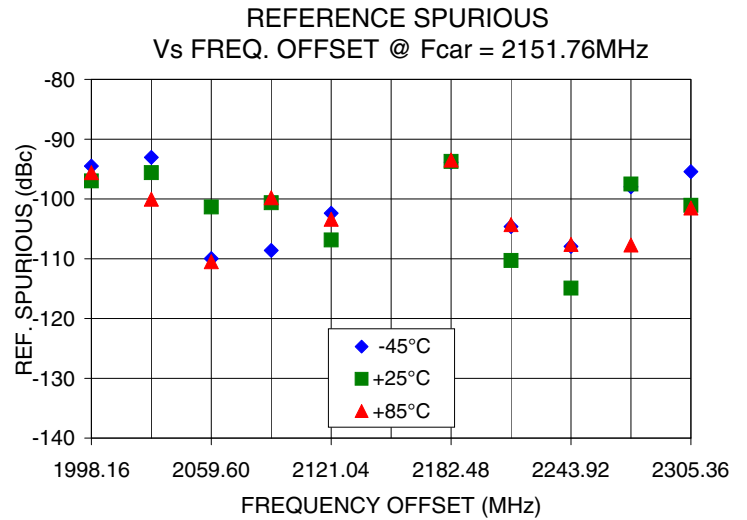
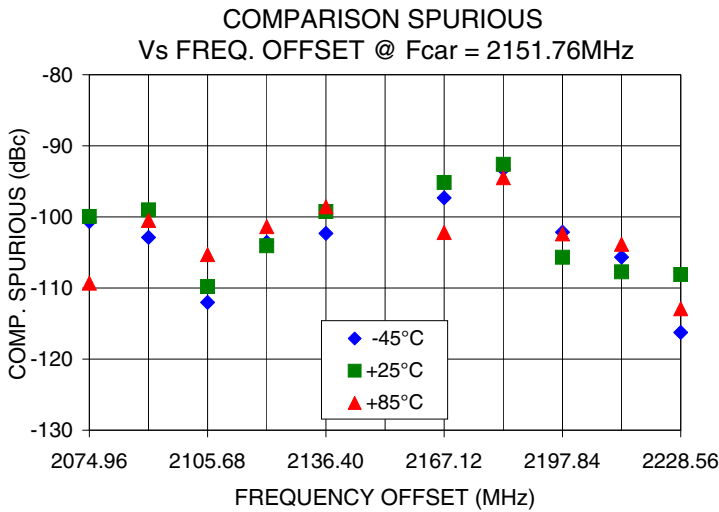

IF/RF MICROWAVE COMPONENTS • ISO 9001 ISO 14001 AS9100 CERTIFIED RoHS compliant
P.O. Box 350166, Brooklyn, New York 11235-0003 (718) 934-4500 Fax (718) 332-4661



The Design Engineers Search Engine finds the model you need, Instantly • For detailed performance specs & shopping online see



Notes: 1. Performance and quality attributes and conditions not expressly stated in this specification sheet are intended to be excluded and do not form a part of this specification sheet. 2. Electrical specifications and performance data contained herein are based on Mini-Circuit's applicable established test performance criteria and measurement instructions. 3. The parts covered by this specification sheet are subject to Mini-Circuits standard limited warranty and terms and conditions (collectively, "Standard Terms"); Purchasers of this part are entitled to the rights and benefits contained therein. For a full statement of the Standard Terms and the exclusive rights and remedies thereunder, please visit Mini-Circuits' website at www.minicircuits.com/MCLStore/terms.jsp.

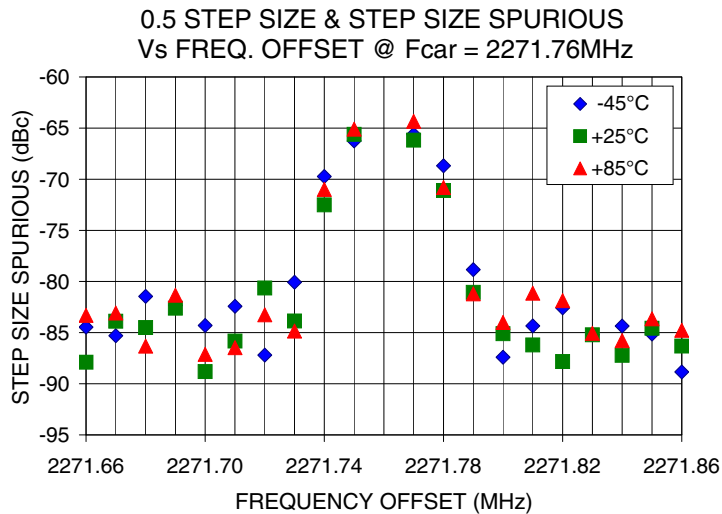
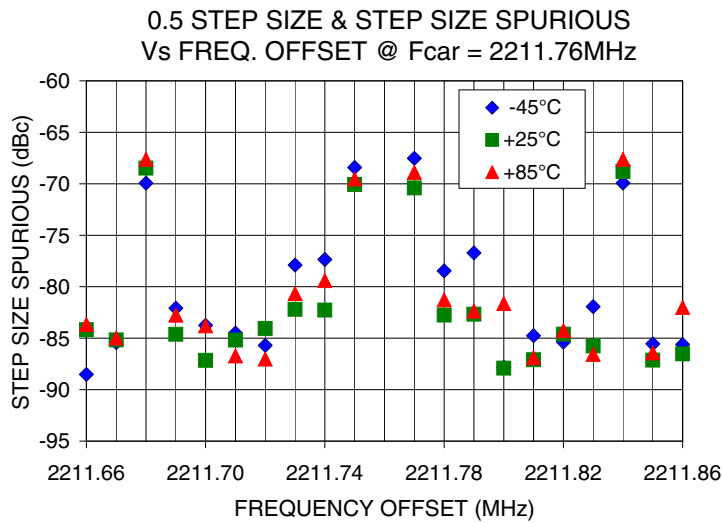
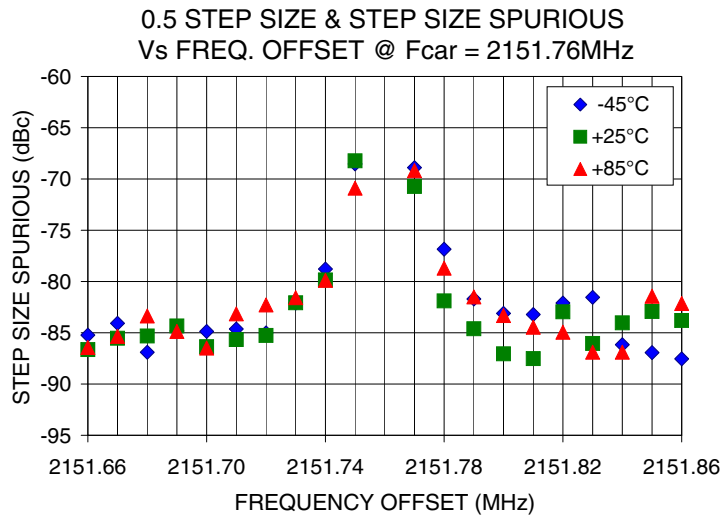

IF/RF MICROWAVE COMPONENTS • ISO 9001 ISO 14001 AS9100 CERTIFIED RoHS compliant
P.O. Box 350166, Brooklyn, New York 11235-0003 (718) 934-4500 Fax (718) 332-4661



The Design Engineers Search Engine finds the model you need, Instantly • For detailed performance specs & shopping online see



Notes: 1. Performance and quality attributes and conditions not expressly stated in this specification sheet are intended to be excluded and do not form a part of this specification sheet. 2. Electrical specifications and performance data contained herein are based on Mini-Circuit's applicable established test performance criteria and measurement instructions. 3. The parts covered by this specification sheet are subject to Mini-Circuits standard limited warranty and terms and conditions (collectively, "Standard Terms"); Purchasers of this part are entitled to the rights and benefits contained therein. For a full statement of the Standard Terms and the exclusive rights and remedies thereunder, please visit Mini-Circuits' website at www.minicircuits.com/MCLStore/terms.jsp.

Pin Configuration

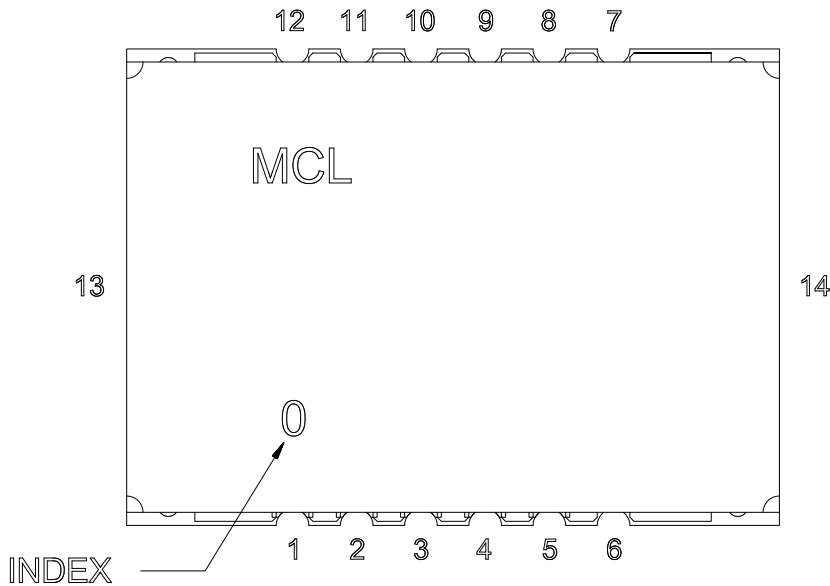

Pin Connection

Pin Number	Function
1	VCC PLL
2	GND
3	REF IN
4	GND
5	VCC VCO
6	GND
7	RF OUT
8	GND
9	LOCK DET
10	CLOCK
11	DATA
12	LE
13	GND
14	GND

Recommended Application Circuit

Note: REF IN and RF OUT ports are internally AC coupled.

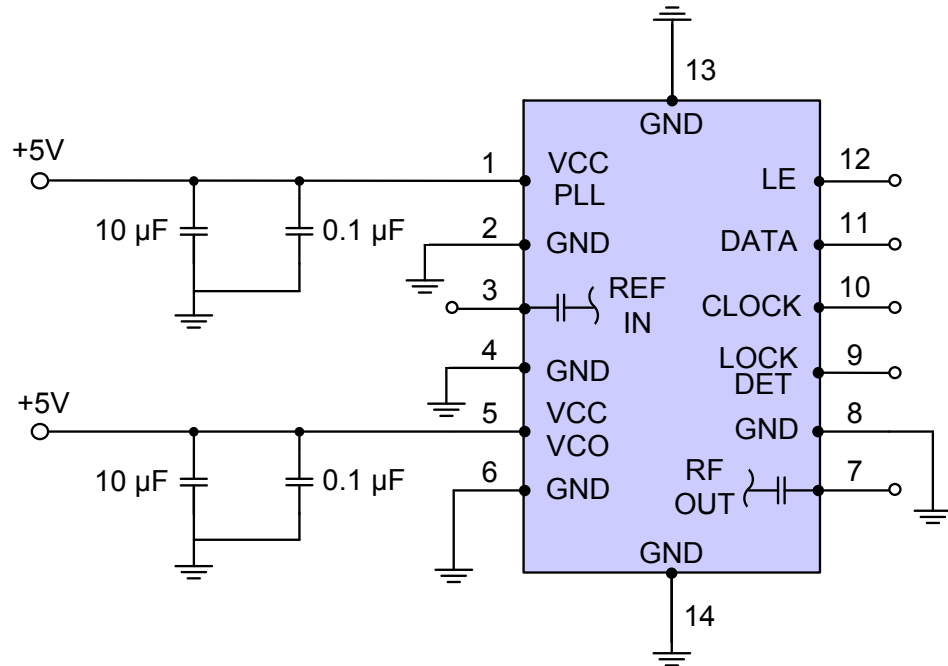

IF/RF MICROWAVE COMPONENTS • ISO 9001 ISO 14001 AS9100 CERTIFIED RoHS compliant
 P.O. Box 350166, Brooklyn, New York 11235-0003 (718) 934-4500 Fax (718) 332-4661



The Design Engineers Search Engine finds the model you need, Instantly • For detailed performance specs & shopping online see



Notes: 1. Performance and quality attributes and conditions not expressly stated in this specification sheet are intended to be excluded and do not form a part of this specification sheet. 2. Electrical specifications and performance data contained herein are based on Mini-Circuit's applicable established test performance criteria and measurement instructions. 3. The parts covered by this specification sheet are subject to Mini-Circuits standard limited warranty and terms and conditions (collectively, "Standard Terms"); Purchasers of this part are entitled to the rights and benefits contained therein. For a full statement of the Standard Terms and the exclusive rights and remedies thereunder, please visit Mini-Circuits' website at www.minicircuits.com/MCLStore/terms.jsp.

Device Marking

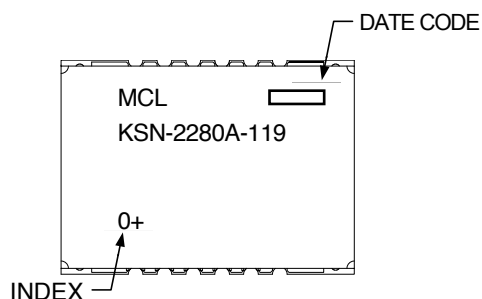

Additional Detailed Technical Information

Additional information is available on our web site. To access this information enter the model number on our web site home page.

Case Style: DK1042

Tape & Reel: TR-F28

Suggested Layout for PCB Design: PL-249

Evaluation Board: TB-567+

Environment Ratings: ENV03T2



IF/RF MICROWAVE COMPONENTS • ISO 9001 ISO 14001 AS9100 CERTIFIED RoHS compliant
P.O. Box 350166, Brooklyn, New York 11235-0003 (718) 934-4500 Fax (718) 332-4661



The Design Engineers Search Engine finds the model you need, Instantly • For detailed performance specs & shopping online see



Notes: 1. Performance and quality attributes and conditions not expressly stated in this specification sheet are intended to be excluded and do not form a part of this specification sheet. 2. Electrical specifications and performance data contained herein are based on Mini-Circuit's applicable established test performance criteria and measurement instructions. 3. The parts covered by this specification sheet are subject to Mini-Circuits standard limited warranty and terms and conditions (collectively, "Standard Terms"); Purchasers of this part are entitled to the rights and benefits contained therein. For a full statement of the Standard Terms and the exclusive rights and remedies thereunder, please visit Mini-Circuits' website at www.minicircuits.com/MCLStore/terms.jsp.