

Frequency Synthesizer

KSN-1700A-319+

50Ω 1600 to 1660 MHz

The Big Deal

- Fractional N synthesizer
- Low phase noise and spurious
- Robust design and construction
- Small size 0.80" x 0.58" x 0.15"



CASE STYLE: DK1042

Product Overview

The KSN-1700A-319+ is a Frequency Synthesizer, designed to operate from 1600 to 1660 MHz for CATV application. The KSN-1700A-319+ is packaged in a metal case (size of 0.80" x 0.58" x 0.15") to shield against unwanted signals and noise.

Key Features

Feature	Advantages
Low phase noise and spurious: <ul style="list-style-type: none">• Phase Noise: -102 dBc/Hz typ. @ 10 kHz offset• Step Size Spurious: -65 dBc typ.• Comparison Spurious: -80 dBc typ.• Reference Spurious: -80 dBc typ.	Low phase noise and spurious improve system EVM (Error Vector Magnitude).
Robust design and construction	To enhance the robustness of KSN-1700A-319+, each internal component is secured to the substrate with chip bonder, thereby eliminating the risk of tombstoning during subsequent solder reflow operations by the customer.
Small size, 0.80" x 0.58" x 0.15"	The small size enables the KSN-1700A-319+ to be used in compact designs.



IF/RF MICROWAVE COMPONENTS • ISO 9001 ISO 14001 AS9100 CERTIFIED RoHS compliant
P.O. Box 350166, Brooklyn, New York 11235-0003 (718) 934-4500 Fax (718) 332-4661



The Design Engineers Search Engine finds the model you need, Instantly • For detailed performance specs & shopping online see minicircuits.com

Notes: 1. Performance and quality attributes and conditions not expressly stated in this specification sheet are intended to be excluded and do not form a part of this specification sheet. 2. Electrical specifications and performance data contained herein are based on Mini-Circuit's applicable established test performance criteria and measurement instructions. 3. The parts covered by this specification sheet are subject to Mini-Circuits standard limited warranty and terms and conditions (collectively, "Standard Terms"); Purchasers of this part are entitled to the rights and benefits contained therein. For a full statement of the Standard Terms and the exclusive rights and remedies thereunder, please visit Mini-Circuits' website at www.minicircuits.com/MCLStore/terms.jsp.

Frequency Synthesizer

KSN-1700A-319+

50Ω 1600 to 1660 MHz

Features

- Fractional N synthesizer
- Integrated VCO + PLL
- Low phase noise and spurious
- Robust design and construction
- Low operating voltage (VCC VCO=+5V, VCC PLL=+3.3V)
- Small size 0.80" x 0.58" x 0.15"

Applications

- CATV

General Description

The KSN-1700A-319+ is a Frequency Synthesizer, designed to operate from 1600 to 1660 MHz for CATV application. The KSN-1700A-319+ is packaged in a metal case (size of 0.80" x 0.58" x 0.15") to shield against unwanted signals and noise. To enhance the robustness of KSN-1700A-319+, each internal component is secured to the substrate with chip bonder, thereby eliminating the risk of tombstoning during subsequent solder reflow operations by the customer.



CASE STYLE: DK1042
PRICE: \$29.95 ea. QTY (1-9)

+ RoHS compliant in accordance with EU Directive (2002/95/EC)

The +Suffix has been added in order to identify RoHS Compliance. See our web site for RoHS Compliance methodologies and qualifications.

Simplified Schematic

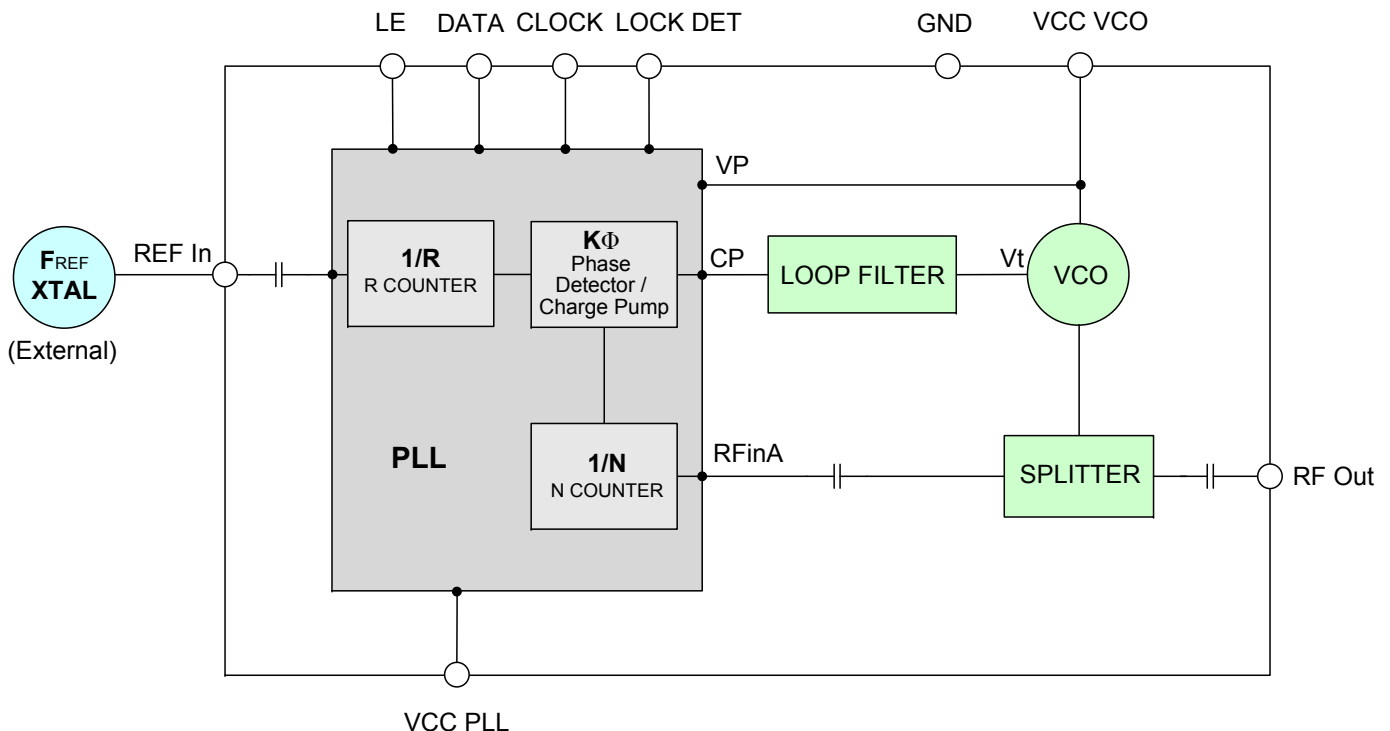

IF/RF MICROWAVE COMPONENTS • ISO 9001 ISO 14001 AS9100 CERTIFIED RoHS compliant
P.O. Box 350166, Brooklyn, New York 11235-0003 (718) 934-4500 Fax (718) 332-4661



The Design Engineers Search Engine finds the model you need, Instantly • For detailed performance specs & shopping online see



Notes: 1. Performance and quality attributes and conditions not expressly stated in this specification sheet are intended to be excluded and do not form a part of this specification sheet. 2. Electrical specifications and performance data contained herein are based on Mini-Circuit's applicable established test performance criteria and measurement instructions. 3. The parts covered by this specification sheet are subject to Mini-Circuits standard limited warranty and terms and conditions (collectively, "Standard Terms"); Purchasers of this part are entitled to the rights and benefits contained therein. For a full statement of the Standard Terms and the exclusive rights and remedies thereunder, please visit Mini-Circuits' website at www.minicircuits.com/MCLStore/terms.jsp.

Electrical Specifications (over operating temperature 0°C to +55°C)

Parameters	Test Conditions	Min.	Typ.	Max.	Units	
Frequency Range	-	1600	-	1660	MHz	
Step Size	-	-	62.5	-	kHz	
Comparison Frequency	-	-	20	-	MHz	
Settling Time	Within ± 1 kHz	-	3.7	-	mSec	
Output Power	-	-2.5	+0.5	+3.5	dBm	
SSB Phase Noise	@ 100 Hz offset	-	-87	-	dBc/Hz	
	@ 1 kHz offset	-	-95	-90		
	@ 10 kHz offset	-	-102	-97		
	@ 100 kHz offset	-	-125	-120		
	@ 1 MHz offset	-	-146	-141		
Integrated SSB Phase Noise	@ 100 Hz to 100kHz offset	-	-52	-	dBc	
Step Size Spurious Suppression	Step Size 62.5 kHz	-	-65	-45	dBc	
0.5 Step Size Spurious Suppression	0.5 Step Size 31.25 kHz	-	-65	-45		
Reference Spurious Suppression	Ref. & Comp. Freq. 20 MHz	-	-80	-60		
Non - Harmonic Spurious Suppression	-	-	-90	-		
Harmonic Suppression	-	-	-20	-15		
VCO Supply Voltage	+5.00	+4.75	+5.00	+5.25	V	
PLL Supply Voltage	+3.30	+3.15	+3.30	+3.45		
VCO Supply Current	-	-	49	55	mA	
PLL Supply Current	-	-	15	22		
Reference Input (External)	Frequency	20 (square wave)	-	20	-	MHz
	Amplitude	1	-	1	-	V _{P-P}
	Input impedance	-	-	100	-	KΩ
	Phase Noise @ 1 kHz offset	-	-	-140	-	dBc/Hz
RF Output port Impedance	-	-	50	-	Ω	
Input Logic Level	Input high voltage	-	2.80	-	-	V
	Input low voltage	-	-	-	0.60	V
Digital Lock Detect	Locked	-	2.75	-	3.45	V
	Unlocked	-	-	-	0.40	V
Frequency Synthesizer PLL	-	ADF4153				
PLL Programming	-	3-wire serial 3.3V CMOS				
Register Map @ 1660 MHz	R0_Register	-	(MSB) 0001010011000000000000 (LSB)			
	R1_Register	-	(MSB) 000100000100010100000001 (LSB)			
	R2_Register	-	(MSB) 0000000000000001111000010 (LSB)			
	R3_Register	-	(MSB) 0000000000000001111000111 (LSB)			

Absolute Maximum Ratings

Parameters	Ratings
VCO Supply Voltage	+5.8V
PLL Supply Voltage	+4.0V
VCO Supply Voltage to PLL Supply Voltage	-0.3V to +5.8V
Reference Frequency Voltage	-0.3Vmin, VCC PLL +0.3Vmax
Data, Clock, LE Levels	-0.3Vmin, VCC PLL +0.3Vmax
Operating Temperature	-40°C to +85°C
Storage Temperature	-55°C to +100°C

Permanent damage may occur if any of these limits are exceeded



IF/RF MICROWAVE COMPONENTS • ISO 9001 ISO 14001 AS9100 CERTIFIED RoHS compliant

P.O. Box 350166, Brooklyn, New York 11235-0003 (718) 934-4500 Fax (718) 332-4661



The Design Engineers Search Engine finds the model you need, Instantly • For detailed performance specs & shopping online see



Notes: 1. Performance and quality attributes and conditions not expressly stated in this specification sheet are intended to be excluded and do not form a part of this specification sheet. 2. Electrical specifications and performance data contained herein are based on Mini-Circuit's applicable established test performance criteria and measurement instructions. 3. The parts covered by this specification sheet are subject to Mini-Circuits standard limited warranty and terms and conditions (collectively, "Standard Terms"); Purchasers of this part are entitled to the rights and benefits contained therein. For a full statement of the Standard Terms and the exclusive rights and remedies thereunder, please visit Mini-Circuits' website at www.minicircuits.com/MCLStore/terms.jsp.

Typical Performance Data

FREQUENCY (MHz)	POWER OUTPUT (dBm)			VCO CURRENT (mA)			PLL CURENT (mA)		
	-5°C	+25°C	+60°C	-5°C	+25°C	+60°C	-5°C	+25°C	+60°C
	1600.0	0.44	0.52	0.58	48.41	48.97	49.84	12.26	13.09
1604.0	0.41	0.49	0.55	48.44	49.00	49.87	13.78	14.64	15.53
1613.5	0.38	0.45	0.51	48.46	49.02	49.70	14.07	14.94	15.84
1623.0	0.42	0.48	0.55	48.48	49.04	49.90	13.86	14.72	15.61
1632.5	0.46	0.53	0.59	48.50	49.06	49.92	14.10	14.97	15.87
1642.0	0.51	0.59	0.65	48.51	49.07	49.94	13.74	14.60	15.5
1651.5	0.55	0.65	0.69	48.52	49.09	49.95	14.14	15.01	15.92
1660.0	0.56	0.69	0.72	48.53	49.10	49.96	12.31	13.13	14.01

FREQUENCY (MHz)	HARMONICS (dBc)					
	F2			F3		
	-5°C	+25°C	+60°C	-5°C	+25°C	+60°C
1600	-21.36	-20.93	-21.24	-34.09	-34.43	-34.71
1604	-20.95	-20.78	-20.94	-34.01	-33.82	-34.15
1614	-20.64	-20.58	-20.60	-32.84	-32.94	-33.54
1623	-21.16	-21.17	-21.15	-32.41	-32.35	-32.87
1633	-21.65	-21.67	-21.80	-30.77	-31.17	-31.42
1642	-21.53	-21.12	-21.74	-30.51	-30.53	-31.38
1652	-21.06	-21.32	-21.19	-29.85	-30.39	-30.97
1660	-21.21	-21.09	-21.24	-29.56	-29.94	-30.51



IF/RF MICROWAVE COMPONENTS • ISO 9001 ISO 14001 AS9100 CERTIFIED RoHS compliant
 P.O. Box 350166, Brooklyn, New York 11235-0003 (718) 934-4500 Fax (718) 332-4661



The Design Engineers Search Engine finds the model you need, Instantly • For detailed performance specs & shopping online see



Notes: 1. Performance and quality attributes and conditions not expressly stated in this specification sheet are intended to be excluded and do not form a part of this specification sheet. 2. Electrical specifications and performance data contained herein are based on Mini-Circuit's applicable established test performance criteria and measurement instructions. 3. The parts covered by this specification sheet are subject to Mini-Circuits standard limited warranty and terms and conditions (collectively, "Standard Terms"); Purchasers of this part are entitled to the rights and benefits contained therein. For a full statement of the Standard Terms and the exclusive rights and remedies thereunder, please visit Mini-Circuits' website at www.minicircuits.com/MCLStore/terms.jsp.

FREQUENCY (MHz)	PHASE NOISE (dBc/Hz) @ OFFSETS				
	+25°C				
	100Hz	1kHz	10kHz	100kHz	1MHz
1600.0	-87.16	-97.38	-103.77	-126.81	-147.63
1604.0	-88.20	-97.46	-103.57	-127.05	-147.54
1613.5	-85.15	-96.54	-103.94	-126.71	-147.42
1623.0	-85.89	-97.27	-103.83	-126.79	-147.15
1632.5	-89.35	-97.24	-103.83	-126.61	-147.41
1642.0	-87.74	-97.28	-103.60	-126.44	-146.97
1651.5	-87.64	-96.24	-103.46	-126.45	-147.23
1660.0	-87.33	-97.60	-103.62	-126.25	-147.26

FREQUENCY (MHz)	PHASE NOISE (dBc/Hz) @ OFFSETS				
	-5°C				
	100Hz	1kHz	10kHz	100kHz	1MHz
1600.0	-86.07	-96.95	-103.88	-127.72	-148.59
1604.0	-88.24	-96.70	-104.45	-127.76	-148.43
1613.5	-85.29	-96.09	-103.54	-127.64	-148.10
1623.0	-88.35	-96.31	-104.33	-127.45	-147.84
1632.5	-86.76	-96.41	-104.34	-127.24	-148.11
1642.0	-86.02	-96.70	-104.53	-127.17	-147.51
1651.5	-85.88	-96.85	-103.42	-127.04	-147.06
1660.0	-88.57	-98.18	-103.41	-126.85	-148.12

FREQUENCY (MHz)	PHASE NOISE (dBc/Hz) @ OFFSETS				
	+60°C				
	100Hz	1kHz	10kHz	100kHz	1MHz
1600.0	-87.09	-99.09	-102.81	-125.44	-146.06
1604.0	-88.70	-96.03	-102.40	-125.53	-145.98
1613.5	-90.67	-95.78	-102.42	-125.79	-146.36
1623.0	-87.31	-97.76	-102.26	-125.25	-145.96
1632.5	-85.29	-96.92	-102.44	-125.21	-146.02
1642.0	-87.96	-98.91	-102.40	-124.98	-145.77
1651.5	-88.86	-98.84	-102.47	-125.01	-145.65
1660.0	-86.98	-97.06	-102.76	-125.07	-145.77



IF/RF MICROWAVE COMPONENTS • ISO 9001 ISO 14001 AS 9100 CERTIFIED RoHS compliant
 P.O. Box 350166, Brooklyn, New York 11235-0003 (718) 934-4500 Fax (718) 332-4661



The Design Engineers Search Engine finds the model you need, Instantly • For detailed performance specs & shopping online see



Notes: 1. Performance and quality attributes and conditions not expressly stated in this specification sheet are intended to be excluded and do not form a part of this specification sheet. 2. Electrical specifications and performance data contained herein are based on Mini-Circuit's applicable established test performance criteria and measurement instructions. 3. The parts covered by this specification sheet are subject to Mini-Circuits standard limited warranty and terms and conditions (collectively, "Standard Terms"); Purchasers of this part are entitled to the rights and benefits contained therein. For a full statement of the Standard Terms and the exclusive rights and remedies thereunder, please visit Mini-Circuits' website at www.minicircuits.com/MCLStore/terms.jsp.

REFERENCE & COMPARISON SPURIOUS ORDER	REFERENCE & COMPARISON SPURIOUS @Fcarrier 1601MHz+(n*Freference) (dBc) note 1			REFERENCE & COMPARISON SPURIOUS @Fcarrier 1641MHz+(n*Freference) (dBc) note 1			REFERENCE & COMPARISON SPURIOUS @Fcarrier 1659MHz+(n*Freference) (dBc) note 1		
	n	-5°C	+25°C	+60°C	-5°C	+25°C	+60°C	-5°C	+25°C
-5	-90.95	-85.59	-86.09	-95.86	-82.85	-85.08	-97.83	-80.60	-87.89
-4	-90.95	-107.09	-92.58	-85.31	-80.32	-89.62	-86.14	-84.89	-89.41
-3	-97.06	-83.59	-90.12	-84.84	-87.03	-87.36	-84.71	-89.61	-86.43
-2	-97.45	-89.25	-100.46	-91.84	-88.46	-91.62	-94.37	-85.58	-97.08
-1	-99.09	-81.38	-93.09	-105.07	-78.93	-96.74	-93.65	-78.32	-90.55
0 note 2	-	-	-	-	-	-	-	-	-
+1	-85.74	-78.74	-87.60	-90.09	-80.49	-87.72	-90.47	-80.36	-86.82
+2	-91.97	-85.88	-90.49	-85.98	-85.13	-86.31	-85.99	-86.49	-85.70
+3	-105.00	-83.51	-97.59	-101.86	-87.01	-94.67	-96.01	-88.60	-92.57
+4	-91.75	-92.19	-87.89	-88.54	-79.53	-89.40	-89.44	-83.14	-88.37
+5	-87.60	-83.00	-85.73	-88.48	-79.29	-88.91	-84.81	-78.02	-85.90

Note 1: Reference frequency = Comparison frequency = 20 MHz

Note 2: All spurs are referenced to carrier signal (n=0).

STEP SIZE SPURIOUS ORDER	0.5 STEP SIZE & STEP SIZE SPURIOUS @Fcarrier 1601MHz+(n*Fstep size) (dBc) note 3			0.5 STEP SIZE & STEP SIZE SPURIOUS @Fcarrier 1641MHz+(n*Fstep size) (dBc) note 3			0.5 STEP SIZE & STEP SIZE SPURIOUS @Fcarrier 1659MHz+(n*Fstep size) (dBc) note 3		
	n	-5°C	+25°C	+60°C	-5°C	+25°C	+60°C	-5°C	+25°C
-5.0	-98.76	-94.13	-93.54	-99.48	-94.90	-102.07	-98.38	-97.19	-99.92
-4.5	-93.97	-91.57	-101.25	-94.39	-93.71	-97.29	-92.10	-85.22	-94.94
-4.0	-95.72	-95.21	-96.14	-94.41	-93.21	-96.33	-90.72	-86.73	-90.57
-3.5	-86.75	-86.72	-87.71	-83.43	-83.32	-84.46	-96.51	-89.11	-94.41
-3.0	-96.25	-90.80	-91.41	-90.80	-84.15	-93.04	-91.84	-89.99	-90.89
-2.5	-84.14	-88.89	-85.72	-80.32	-86.99	-80.25	-72.82	-74.60	-74.54
-2.0	-85.88	-89.35	-86.33	-87.88	-88.30	-88.39	-85.22	-73.95	-85.31
-1.5	-74.65	-75.47	-78.11	-72.21	-73.20	-74.77	-83.95	-75.34	-86.96
-1.0	-69.82	-67.24	-71.99	-65.63	-64.57	-68.40	-71.26	-71.34	-75.03
-0.5	-73.64	-66.07	-68.76	-72.75	-64.78	-67.63	-68.41	-75.20	-74.01
0 note 4	-	-	-	-	-	-	-	-	-
+0.5	-71.15	-66.06	-68.96	-71.01	-64.76	-67.01	-68.34	-76.07	-73.17
+1.0	-68.93	-65.90	-71.33	-66.36	-64.03	-67.87	-71.43	-71.02	-73.33
+1.5	-76.69	-75.18	-78.55	-73.01	-72.02	-73.83	-84.39	-76.51	-85.45
+2.0	-84.30	-85.61	-83.82	-88.04	-88.29	-86.78	-85.43	-74.68	-84.33
+2.5	-82.82	-88.51	-80.66	-79.79	-85.71	-80.59	-73.27	-74.00	-74.45
+3.0	-95.94	-86.67	-92.98	-91.51	-86.46	-93.86	-89.37	-88.60	-95.94
+3.5	-85.22	-86.10	-84.77	-85.93	-83.11	-86.46	-93.19	-89.77	-95.09
+4.0	-99.05	-91.73	-99.73	-95.77	-91.04	-98.04	-88.99	-86.87	-90.77
+4.5	-95.25	-91.90	-100.43	-93.79	-92.52	-98.68	-93.86	-84.92	-96.00
+5.0	-99.46	-98.26	-100.36	-98.28	-96.25	-100.98	-99.26	-97.57	-101.34

Note 3: Step size 62.5 kHz

Note 4: All spurs are referenced to carrier signal (n=0).



The Design Engineers Search Engine finds the model you need, Instantly • For detailed performance specs & shopping online see minicircuits.com

Notes: 1. Performance and quality attributes and conditions not expressly stated in this specification sheet are intended to be excluded and do not form a part of this specification sheet. 2. Electrical specifications and performance data contained herein are based on Mini-Circuit's applicable established test performance criteria and measurement instructions. 3. The parts covered by this specification sheet are subject to Mini-Circuits standard limited warranty and terms and conditions (collectively, "Standard Terms"); Purchasers of this part are entitled to the rights and benefits contained therein. For a full statement of the Standard Terms and the exclusive rights and remedies thereunder, please visit Mini-Circuits' website at www.minicircuits.com/MCLStore/terms.jsp.

Typical Performance Curves

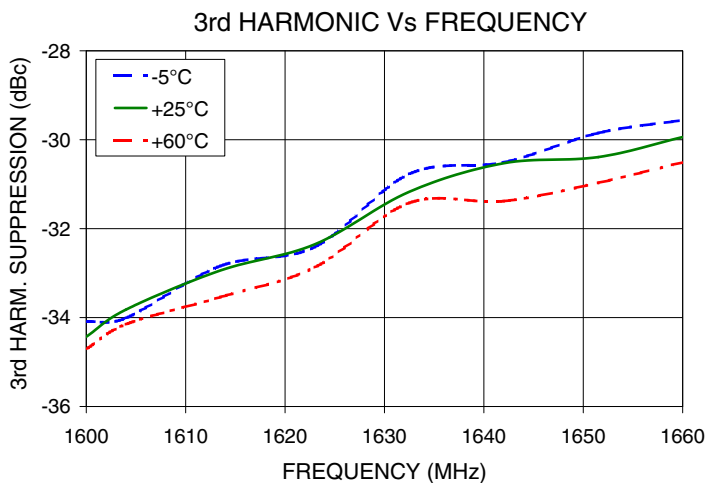
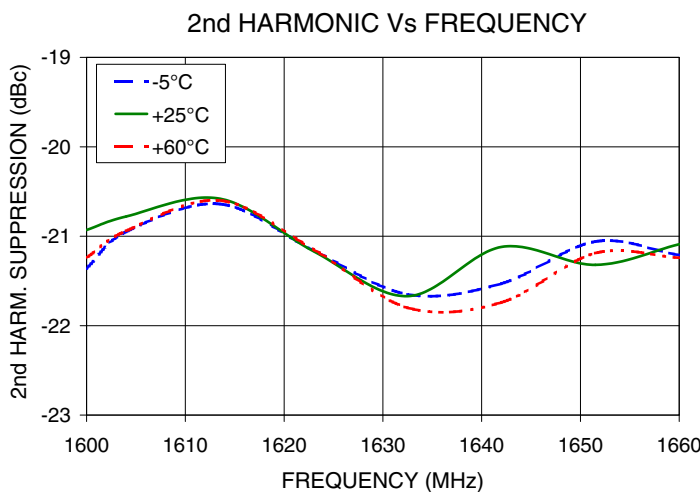
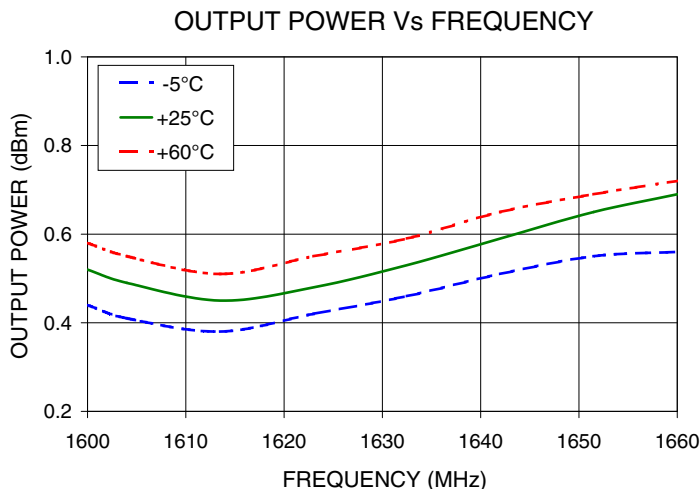

IF/RF MICROWAVE COMPONENTS • ISO 9001 ISO 14001 AS9100 CERTIFIED RoHS compliant
 P.O. Box 350166, Brooklyn, New York 11235-0003 (718) 934-4500 Fax (718) 332-4661



The Design Engineers Search Engine finds the model you need, Instantly • For detailed performance specs & shopping online see



Notes: 1. Performance and quality attributes and conditions not expressly stated in this specification sheet are intended to be excluded and do not form a part of this specification sheet. 2. Electrical specifications and performance data contained herein are based on Mini-Circuit's applicable established test performance criteria and measurement instructions. 3. The parts covered by this specification sheet are subject to Mini-Circuits standard limited warranty and terms and conditions (collectively, "Standard Terms"); Purchasers of this part are entitled to the rights and benefits contained therein. For a full statement of the Standard Terms and the exclusive rights and remedies thereunder, please visit Mini-Circuits' website at www.minicircuits.com/MCLStore/terms.jsp.

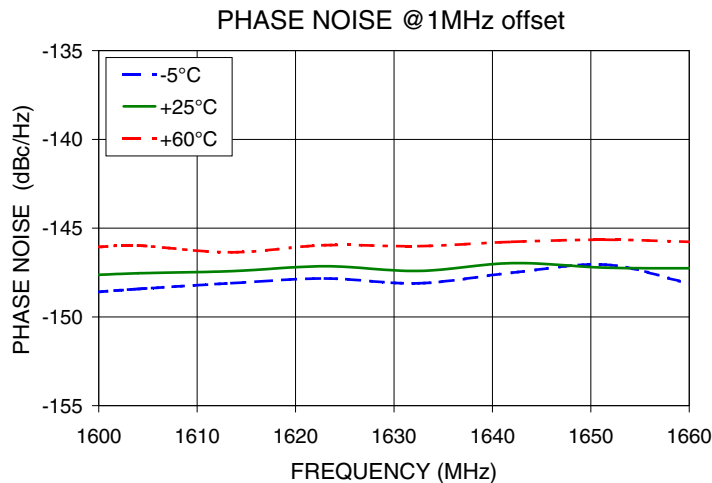
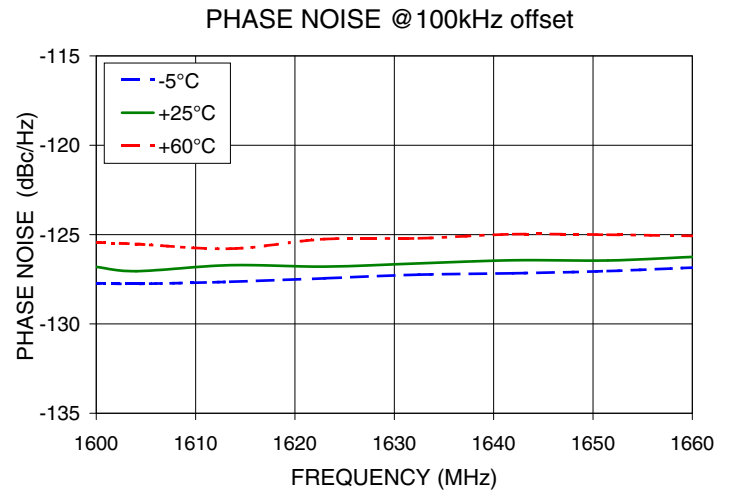
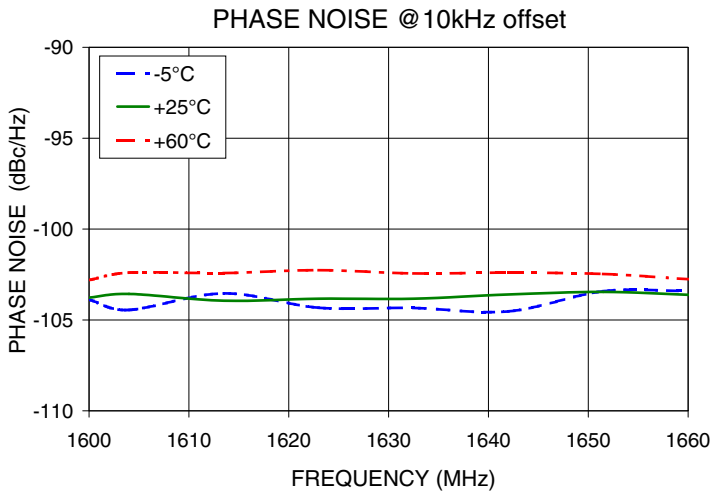
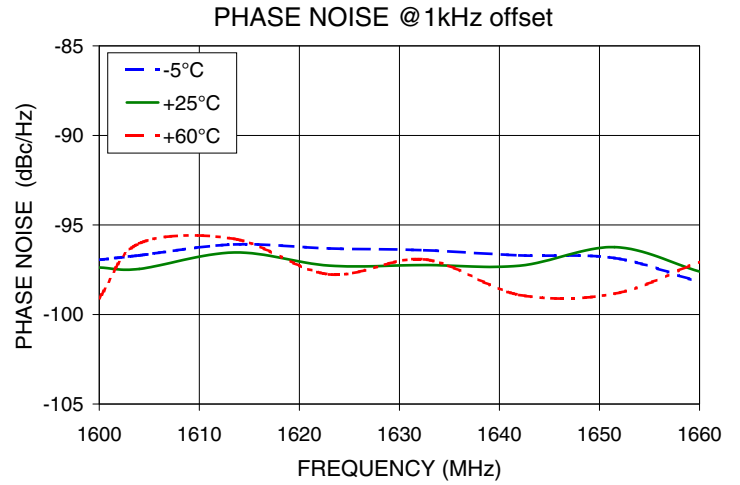
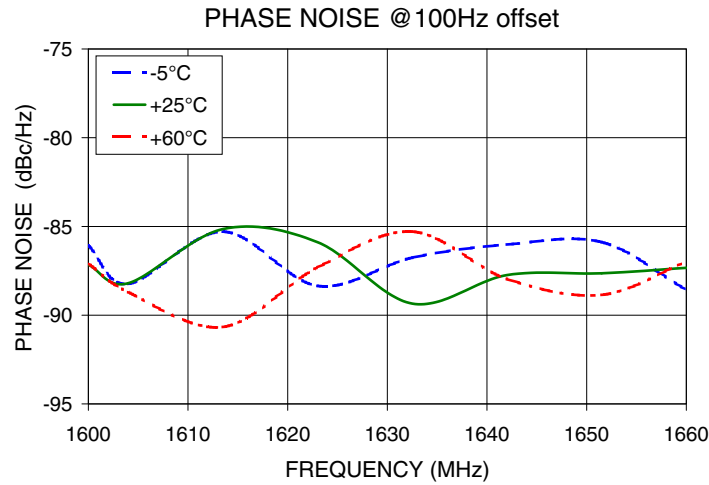

IF/RF MICROWAVE COMPONENTS • ISO 9001 ISO 14001 AS9100 CERTIFIED RoHS compliant
 P.O. Box 350166, Brooklyn, New York 11235-0003 (718) 934-4500 Fax (718) 332-4661



The Design Engineers Search Engine finds the model you need, Instantly • For detailed performance specs & shopping online see



Notes: 1. Performance and quality attributes and conditions not expressly stated in this specification sheet are intended to be excluded and do not form a part of this specification sheet. 2. Electrical specifications and performance data contained herein are based on Mini-Circuit's applicable established test performance criteria and measurement instructions. 3. The parts covered by this specification sheet are subject to Mini-Circuits standard limited warranty and terms and conditions (collectively, "Standard Terms"); Purchasers of this part are entitled to the rights and benefits contained therein. For a full statement of the Standard Terms and the exclusive rights and remedies thereunder, please visit Mini-Circuits' website at www.minicircuits.com/MCLStore/terms.jsp.

REFERENCE & COMPARISON SPURIOUS
Vs FREQ. OFFSET @ Fcar = 1601MHz

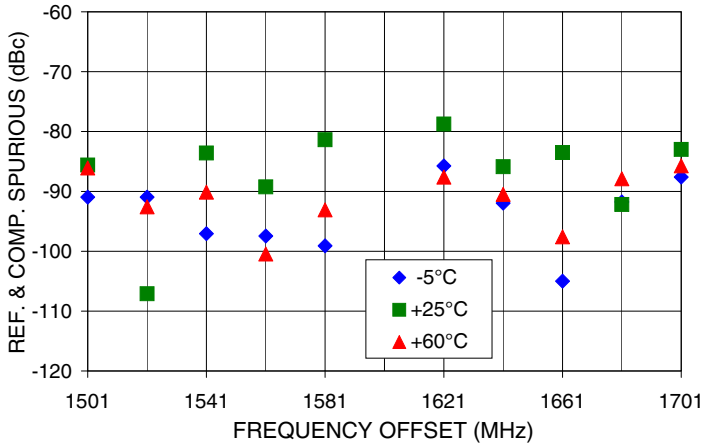

0.5 STEP SIZE & STEP SIZE SPURIOUS
Vs FREQ. OFFSET @ Fcar = 1601MHz

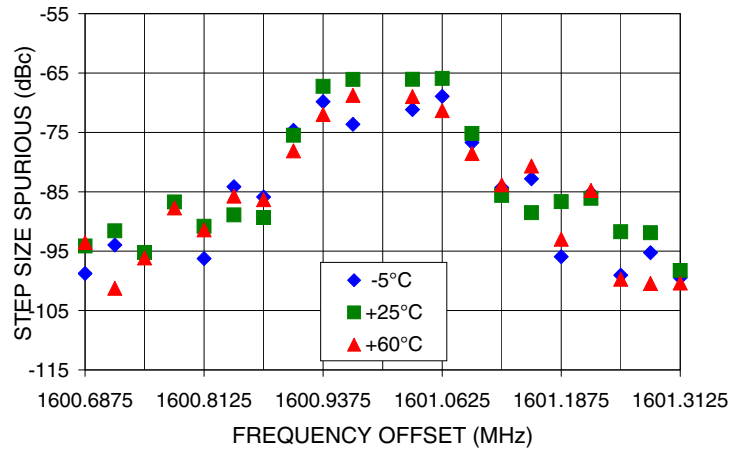

REFERENCE & COMPARISON SPURIOUS
Vs FREQ. OFFSET @ Fcar = 1641MHz

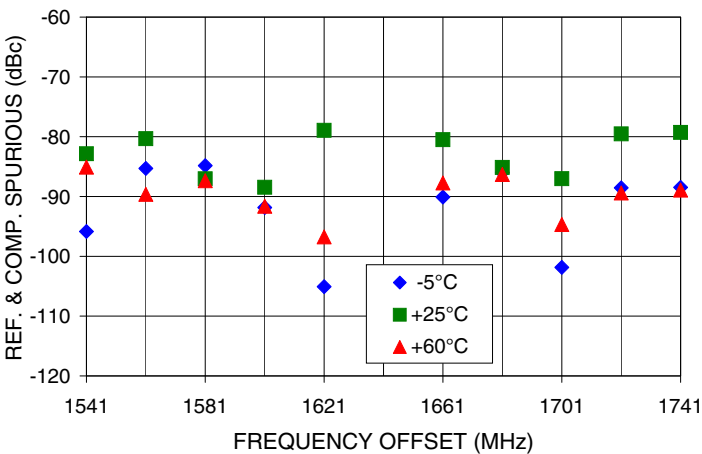

0.5 STEP SIZE & STEP SIZE SPURIOUS
Vs FREQ. OFFSET @ Fcar = 1641MHz

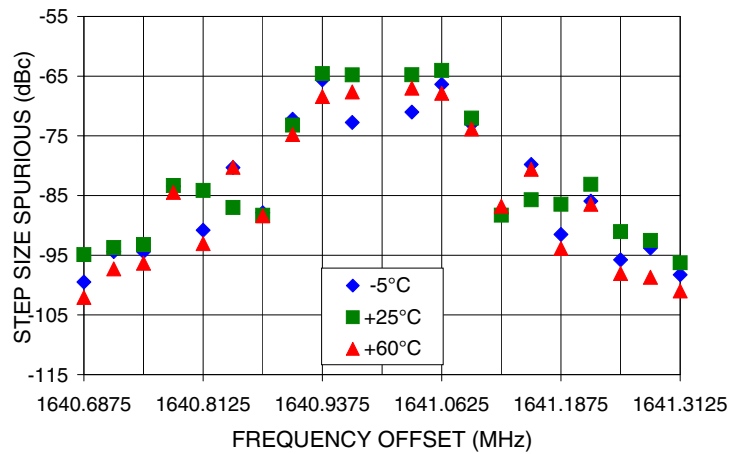

REFERENCE & COMPARISON SPURIOUS
Vs FREQ. OFFSET @ Fcar = 1659MHz

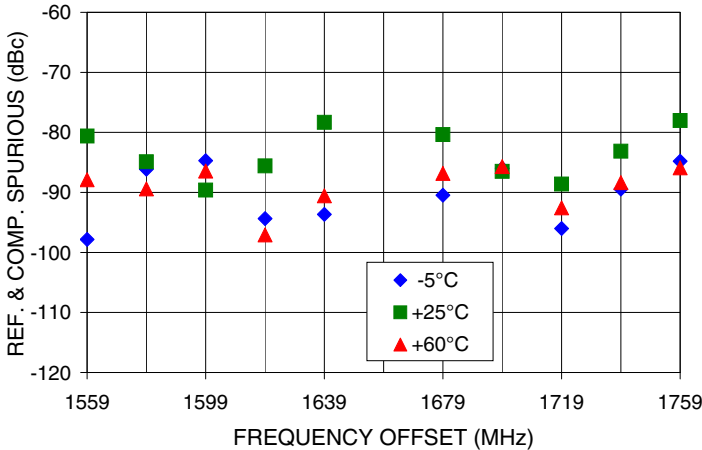

0.5 STEP SIZE & STEP SIZE SPURIOUS
Vs FREQ. OFFSET @ Fcar = 1659MHz

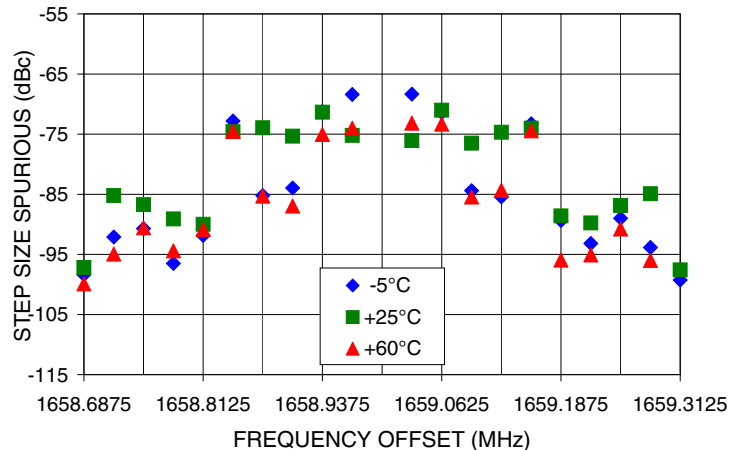

IF/RF MICROWAVE COMPONENTS • ISO 9001 ISO 14001 AS 9100 CERTIFIED RoHS compliant
P.O. Box 350166, Brooklyn, New York 11235-0003 (718) 934-4500 Fax (718) 332-4661



The Design Engineers Search Engine finds the model you need, Instantly • For detailed performance specs & shopping online see



Notes: 1. Performance and quality attributes and conditions not expressly stated in this specification sheet are intended to be excluded and do not form a part of this specification sheet. 2. Electrical specifications and performance data contained herein are based on Mini-Circuit's applicable established test performance criteria and measurement instructions. 3. The parts covered by this specification sheet are subject to Mini-Circuits standard limited warranty and terms and conditions (collectively, "Standard Terms"); Purchasers of this part are entitled to the rights and benefits contained therein. For a full statement of the Standard Terms and the exclusive rights and remedies thereunder, please visit Mini-Circuits' website at www.minicircuits.com/MCLStore/terms.jsp.

Pin Configuration

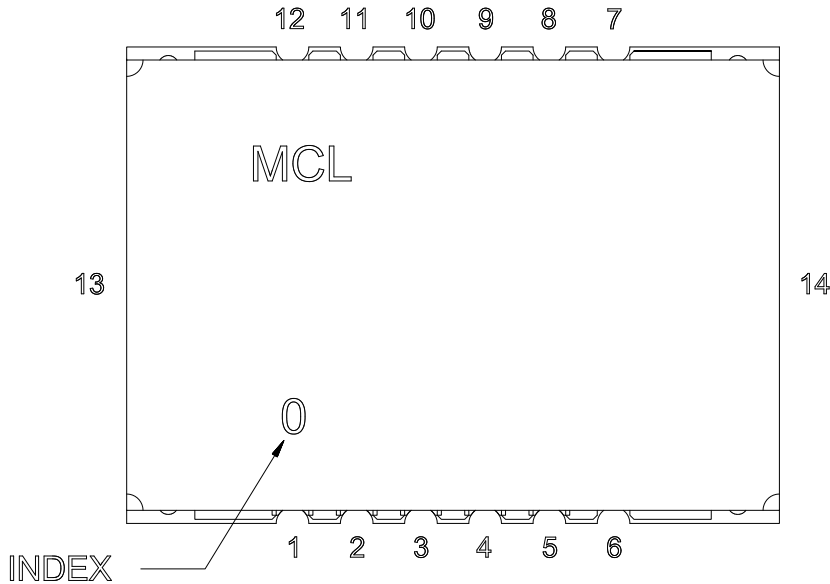

Pin Connection

Pin Number	Function
1	VCC PLL
2	GND
3	REF IN
4	GND
5	VCC VCO
6	GND
7	RF OUT
8	GND
9	LOCK DET
10	CLOCK
11	DATA
12	LE
13	GND
14	GND

Recommended Application Circuit

Note: REF IN and RF OUT ports are internally AC coupled.

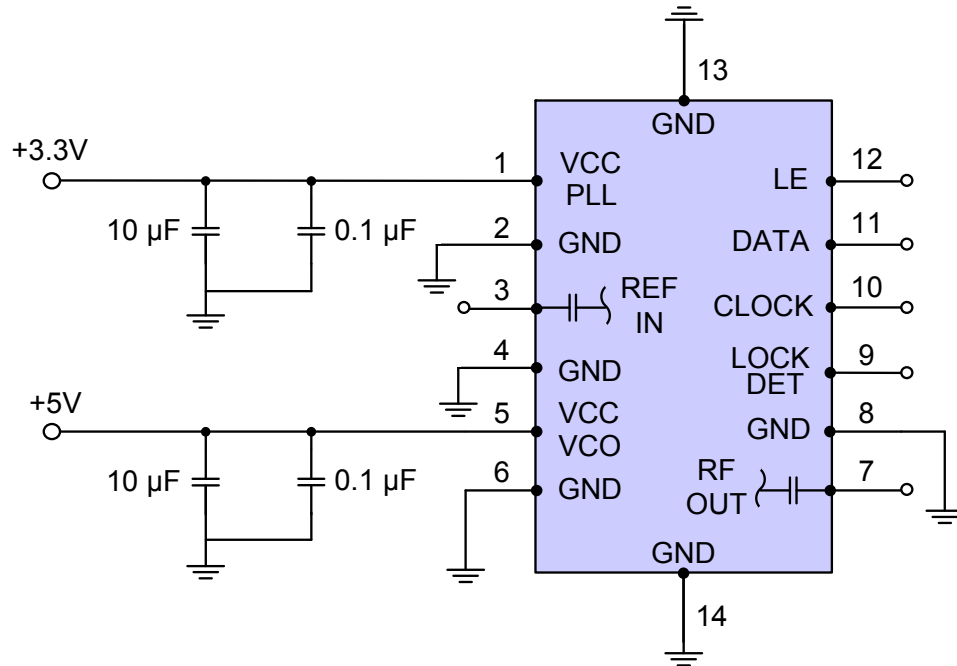

IF/RF MICROWAVE COMPONENTS • ISO 9001 ISO 14001 AS9100 CERTIFIED RoHS compliant
 P.O. Box 350166, Brooklyn, New York 11235-0003 (718) 934-4500 Fax (718) 332-4661



The Design Engineers Search Engine finds the model you need, Instantly • For detailed performance specs & shopping online see



Notes: 1. Performance and quality attributes and conditions not expressly stated in this specification sheet are intended to be excluded and do not form a part of this specification sheet. 2. Electrical specifications and performance data contained herein are based on Mini-Circuit's applicable established test performance criteria and measurement instructions. 3. The parts covered by this specification sheet are subject to Mini-Circuits standard limited warranty and terms and conditions (collectively, "Standard Terms"); Purchasers of this part are entitled to the rights and benefits contained therein. For a full statement of the Standard Terms and the exclusive rights and remedies thereunder, please visit Mini-Circuits' website at www.minicircuits.com/MCLStore/terms.jsp.

Device Marking

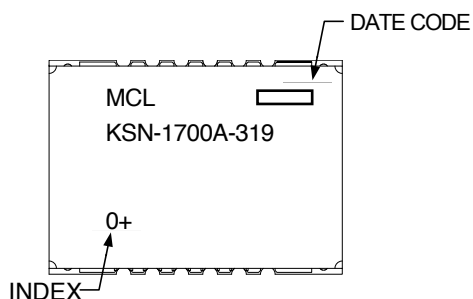

Additional Detailed Technical Information

Additional information is available on our web site. To access this information enter the model number on our web site home page.

Case Style: DK1042

Tape & Reel: TR-F28

Suggested Layout for PCB Design: PL-249

Evaluation Board: TB-567-1+

Environment Ratings: ENV03T2



IF/RF MICROWAVE COMPONENTS • ISO 9001 ISO 14001 AS 9100 CERTIFIED RoHS compliant

P.O. Box 350166, Brooklyn, New York 11235-0003 (718) 934-4500 Fax (718) 332-4661



The Design Engineers Search Engine finds the model you need, Instantly • For detailed performance specs & shopping online see



Notes: 1. Performance and quality attributes and conditions not expressly stated in this specification sheet are intended to be excluded and do not form a part of this specification sheet. 2. Electrical specifications and performance data contained herein are based on Mini-Circuit's applicable established test performance criteria and measurement instructions. 3. The parts covered by this specification sheet are subject to Mini-Circuits standard limited warranty and terms and conditions (collectively, "Standard Terms"); Purchasers of this part are entitled to the rights and benefits contained therein. For a full statement of the Standard Terms and the exclusive rights and remedies thereunder, please visit Mini-Circuits' website at www.minicircuits.com/MCLStore/terms.jsp.