

Frequency Synthesizer

KSN-1150A-119+

50Ω 1150 to 1160 MHz

The Big Deal

- Low phase noise and spurious
- Robust design and construction
- Small size 0.80" x 0.58" x 0.15"



CASE STYLE: DK801

Product Overview

The KSN-1150A-119+ is a Frequency Synthesizer, designed to operate from 1150 to 1160 MHz for CATV application. The KSN-1150A-119+ is packaged in a metal case (size of 0.80" x 0.58" x 0.15") to shield against unwanted signals and noise.

Key Features

Feature	Advantages
Low phase noise and spurious: <ul style="list-style-type: none">• Phase Noise: -109 dBc/Hz typ. @ 10 kHz offset• Comparison Spurious: -94 dBc typ.• Reference Spurious: -114 dBc typ.	Low phase noise and spurious improve system EVM (Error Vector Magnitude).
Robust design and construction	To enhance the robustness of KSN-1150A-119+, each internal component is secured to the substrate with chip bonder, thereby eliminating the risk of tombstoning during subsequent solder reflow operations by the customer.
Small size, 0.80" x 0.58" x 0.15"	The small size enables the KSN-1150A-119+ to be used in compact designs.



IF/RF MICROWAVE COMPONENTS • ISO 9001 ISO 14001 AS9100 CERTIFIED RoHS compliant
P.O. Box 350166, Brooklyn, New York 11235-0003 (718) 934-4500 Fax (718) 332-4661



The Design Engineers Search Engine finds the model you need, Instantly • For detailed performance specs & shopping online see minicircuits.com

Notes: 1. Performance and quality attributes and conditions not expressly stated in this specification sheet are intended to be excluded and do not form a part of this specification sheet. 2. Electrical specifications and performance data contained herein are based on Mini-Circuit's applicable established test performance criteria and measurement instructions. 3. The parts covered by this specification sheet are subject to Mini-Circuits standard limited warranty and terms and conditions (collectively, "Standard Terms"); Purchasers of this part are entitled to the rights and benefits contained therein. For a full statement of the Standard Terms and the exclusive rights and remedies thereunder, please visit Mini-Circuits' website at www.minicircuits.com/MCLStore/terms.jsp.

Frequency Synthesizer

KSN-1150A-119+

50Ω 1150 to 1160 MHz

Features

- Integrated VCO + PLL
- Low phase noise and spurious
- Robust design and construction
- Low operating voltage (VCC VCO=+5V, VCC PLL=+5V)
- Small size 0.80" x 0.58" x 0.15"

Applications

- CATV

General Description

The KSN-1150A-119+ is a Frequency Synthesizer, designed to operate from 1150 to 1160 MHz for CATV application. The KSN-1150A-119+ is packaged in a metal case (size of 0.80" x 0.58" x 0.15") to shield against unwanted signals and noise. To enhance the robustness of KSN-1150A-119+, each internal component is secured to the substrate with chip bonder, thereby eliminating the risk of tombstoning during subsequent solder reflow operations by the customer.



CASE STYLE: DK801
PRICE: \$29.95 ea. QTY (1-9)

+ RoHS compliant in accordance with EU Directive (2002/95/EC)

The +Suffix has been added in order to identify RoHS Compliance. See our web site for RoHS Compliance methodologies and qualifications.

Simplified Schematic



IF/RF MICROWAVE COMPONENTS • ISO 9001 ISO 14001 AS9100 CERTIFIED RoHS compliant
P.O. Box 350166, Brooklyn, New York 11235-0003 (718) 934-4500 Fax (718) 332-4661



The Design Engineers Search Engine finds the model you need, Instantly • For detailed performance specs & shopping online see



Notes: 1. Performance and quality attributes and conditions not expressly stated in this specification sheet are intended to be excluded and do not form a part of this specification sheet. 2. Electrical specifications and performance data contained herein are based on Mini-Circuit's applicable established test performance criteria and measurement instructions. 3. The parts covered by this specification sheet are subject to Mini-Circuits standard limited warranty and terms and conditions (collectively, "Standard Terms"); Purchasers of this part are entitled to the rights and benefits contained therein. For a full statement of the Standard Terms and the exclusive rights and remedies thereunder, please visit Mini-Circuits' website at www.minicircuits.com/MCLStore/terms.jsp.

Electrical Specifications (over operating temperature -40°C to +85°C)

Parameters		Test Conditions	Min.	Typ.	Max.	Units
Frequency Range		-	1150	-	1160	MHz
Step Size		-	-	250	-	kHz
Settling Time		Within ± 1 kHz	-	5	-	mSec
Output Power		-	-0.5	+2.0	+4.5	dBm
SSB Phase Noise		@ 100 Hz offset	-	-85	-	dBc/Hz
		@ 1 kHz offset	-	-85	-76	
		@ 10 kHz offset	-	-109	-101	
		@ 100 kHz offset	-	-134	-128	
		@ 1 MHz offset	-	-154	-147	
Integrated SSB Phase Noise		@100 Hz - 1 MHz	-	-49	-46	dBc
Reference Spurious Suppression		Ref. Freq. 20 MHz	-	-114	-89	dBc
Comparison Spurious Suppression		Step Size 250 kHz	-	-94	-73	
Non - Harmonic Spurious Suppression		-	-	-90	-	
Harmonic Suppression		-	-	-38	-26	
VCO Supply Voltage		+5.00	+4.75	+5.00	+5.25	
PLL Supply Voltage		+5.00	+4.75	+5.00	+5.25	
VCO Supply Current		-	-	35	42	mA
PLL Supply Current		-	-	20	27	
Reference Input (External)	Frequency	20 (square wave)	-	20	-	MHz
	Amplitude	1	-	1	-	V _{P-P}
	Input impedance	-	-	100	-	K Ω
	Phase Noise @ 1 kHz offset	-	-	-145	-	dBc/Hz
RF Output port Impedance		-	-	50	-	Ω
Input Logic Level	Input high voltage	-	2.50	-	-	V
	Input low voltage	-	-	-	0.55	V
Digital Lock Detect	Locked	-	2.40	-	3.15	V
	Unlocked	-	-	-	0.40	V
Frequency Synthesizer PLL		-	ADF4106			
PLL Programming		-	3-wire serial 3V CMOS			
Register Map @ 1160MHz	F_Register	-	(MSB) 00011111000000010010011 (LSB)			
	N_Register	-	(MSB) 001000100100010000000001 (LSB)			
	R_Register	-	(MSB) 000100000000000101000000 (LSB)			

Absolute Maximum Ratings

Parameters	Ratings
VCO Supply Voltage	5.8V
PLL Supply Voltage	5.8V
VCO Supply Voltage to PLL Supply Voltage	-0.3V to +5.8V
Reference Frequency Voltage	-0.3Vmin, +3.15Vmax
Data, Clock, LE Levels	-0.3Vmin, +3.15Vmax
Operating Temperature	-40°C to +85°C
Storage Temperature	-55°C to +100°C

Permanent damage may occur if any of these limits are exceeded



IF/RF MICROWAVE COMPONENTS • ISO 9001 ISO 14001 AS 9100 CERTIFIED RoHS compliant

P.O. Box 350166, Brooklyn, New York 11235-0003 (718) 934-4500 Fax (718) 332-4661



The Design Engineers Search Engine finds the model you need, Instantly • For detailed performance specs & shopping online see minicircuits.com

Notes: 1. Performance and quality attributes and conditions not expressly stated in this specification sheet are intended to be excluded and do not form a part of this specification sheet. 2. Electrical specifications and performance data contained herein are based on Mini-Circuit's applicable established test performance criteria and measurement instructions. 3. The parts covered by this specification sheet are subject to Mini-Circuits standard limited warranty and terms and conditions (collectively, "Standard Terms"); Purchasers of this part are entitled to the rights and benefits contained therein. For a full statement of the Standard Terms and the exclusive rights and remedies thereunder, please visit Mini-Circuits' website at www.minicircuits.com/MCLStore/terms.jsp.

Typical Performance Data

FREQUENCY (MHz)	POWER OUTPUT (dBm)			VCO CURRENT (mA)			PLL CURENT (mA)		
	-45°C	+25°C	+85°C	-45°C	+25°C	+85°C	-45°C	+25°C	+85°C
	1150.0	2.07	2.19	2.20	33.03	35.17	36.55	19.79	20.27
1152.0	2.05	2.17	2.18	33.02	35.17	36.55	19.79	20.27	21.24
1154.0	2.03	2.14	2.16	33.02	35.17	36.56	19.79	20.27	21.24
1156.0	2.01	2.12	2.14	33.01	35.17	36.56	19.79	20.27	21.24
1158.0	1.99	2.10	2.12	33.01	35.17	36.56	19.79	20.27	21.25
1160.0	1.96	2.07	2.09	33.00	35.17	36.55	19.79	20.27	21.25

FREQUENCY (MHz)	HARMONICS (dBc)					
	F2			F3		
	-45°C	+25°C	+85°C	-45°C	+25°C	+85°C
1150.0	-41.18	-39.54	-43.01	-33.44	-36.50	-38.49
1152.0	-42.28	-39.95	-43.73	-33.66	-36.84	-38.82
1154.0	-43.37	-40.37	-44.46	-33.89	-37.19	-39.16
1156.0	-44.47	-40.78	-45.18	-34.11	-37.53	-39.49
1158.0	-46.33	-41.70	-46.47	-33.75	-37.43	-39.56
1160.0	-48.19	-42.62	-47.76	-33.38	-37.33	-39.62

FREQUENCY (MHz)	PHASE NOISE (dBc/Hz) @ OFFSETS				
	+25°C				
	100Hz	1kHz	10kHz	100kHz	1MHz
1150.0	-83.65	-85.74	-109.60	-134.66	-153.90
1152.0	-84.82	-85.65	-109.53	-134.66	-154.18
1154.0	-86.00	-85.55	-109.45	-134.67	-154.45
1156.0	-87.17	-85.46	-109.38	-134.67	-154.73
1158.0	-87.57	-85.51	-109.33	-134.54	-154.70
1160.0	-87.97	-85.56	-109.27	-134.40	-154.66

FREQUENCY (MHz)	PHASE NOISE (dBc/Hz) @ OFFSETS				
	-45°C				
	100Hz	1kHz	10kHz	100kHz	1MHz
1150.0	-82.72	-86.28	-107.49	-131.99	-151.86
1152.0	-83.71	-86.42	-107.33	-131.87	-151.59
1154.0	-84.69	-86.57	-107.16	-131.76	-151.32
1156.0	-85.68	-86.71	-107.00	-131.64	-151.05
1158.0	-85.14	-85.37	-107.19	-131.58	-150.77
1160.0	-84.60	-84.03	-107.37	-131.52	-150.48

FREQUENCY (MHz)	PHASE NOISE (dBc/Hz) @ OFFSETS				
	+85°C				
	100Hz	1kHz	10kHz	100kHz	1MHz
1150.0	-84.73	-88.32	-108.52	-132.39	-152.44
1152.0	-85.65	-86.70	-108.53	-132.40	-152.44
1154.0	-86.58	-85.09	-108.53	-132.41	-152.45
1156.0	-87.50	-83.47	-108.54	-132.42	-152.45
1158.0	-86.77	-82.78	-108.25	-132.41	-152.17
1160.0	-86.03	-82.08	-107.96	-132.40	-151.89



IF/RF MICROWAVE COMPONENTS • ISO 9001 ISO 14001 AS9100 CERTIFIED RoHS compliant
 P.O. Box 350166, Brooklyn, New York 11235-0003 (718) 934-4500 Fax (718) 332-4661



The Design Engineers Search Engine finds the model you need, Instantly • For detailed performance specs & shopping online see



Notes: 1. Performance and quality attributes and conditions not expressly stated in this specification sheet are intended to be excluded and do not form a part of this specification sheet. 2. Electrical specifications and performance data contained herein are based on Mini-Circuit's applicable established test performance criteria and measurement instructions. 3. The parts covered by this specification sheet are subject to Mini-Circuits standard limited warranty and terms and conditions (collectively, "Standard Terms"); Purchasers of this part are entitled to the rights and benefits contained therein. For a full statement of the Standard Terms and the exclusive rights and remedies thereunder, please visit Mini-Circuits' website at www.minicircuits.com/MCLStore/terms.jsp.

COMPARISON SPURIOUS ORDER	COMPARISON SPURIOUS @Fcarrier 1150MHz+(n*Fcomparison) (dBc) note 1			COMPARISON SPURIOUS @Fcarrier 1155MHz+(n*Fcomparison) (dBc) note 1			COMPARISON SPURIOUS @Fcarrier 1160MHz+(n*Fcomparison) (dBc) note 1			
	n	-45°C	+25°C	+85°C	-45°C	+25°C	+85°C	-45°C	+25°C	+85°C
	-5	-104.15	-119.49	-104.75	-100.97	-108.03	-109.49	-96.30	-107.01	-116.86
-4	-99.88	-120.25	-105.25	-96.28	-106.06	-114.36	-93.82	-104.85	-114.69	
-3	-97.52	-116.59	-103.93	-94.29	-104.27	-107.46	-90.34	-105.06	-110.74	
-2	-93.99	-108.40	-99.24	-90.73	-101.82	-103.44	-87.89	-101.74	-111.14	
-1	-87.91	-99.42	-91.40	-83.17	-94.54	-95.62	-81.45	-89.58	-98.38	
0 ^{note 2}	-	-	-	-	-	-	-	-	-	
+1	-85.38	-97.03	-91.36	-83.49	-93.13	-99.20	-81.22	-93.24	-99.23	
+2	-94.21	-111.07	-100.97	-90.53	-100.83	-102.15	-87.25	-100.62	-112.71	
+3	-97.96	-113.01	-103.58	-94.42	-103.08	-107.06	-90.17	-104.54	-115.62	
+4	-99.10	-118.99	-103.80	-96.31	-105.58	-110.06	-93.12	-105.04	-115.51	
+5	-102.18	-119.02	-104.03	-99.36	-105.51	-108.74	-95.01	-105.64	-119.54	

Note 1: Comparison frequency 250 kHz
 Note 2: All spurs are referenced to carrier signal (n=0).

REFERENCE SPURIOUS ORDER	REFERENCE SPURIOUS @Fcarrier 1150MHz+(n*Freference) (dBc) note 3			REFERENCE SPURIOUS @Fcarrier 1155MHz+(n*Freference) (dBc) note 3			REFERENCE SPURIOUS @Fcarrier 1160MHz+(n*Freference) (dBc) note 3			
	n	-45°C	+25°C	+85°C	-45°C	+25°C	+85°C	-45°C	+25°C	+85°C
	-5	-109.78	-115.93	-117.25	-116.76	-115.34	-120.75	-108.21	-109.12	-113.51
-4	-111.55	-122.04	-118.56	-114.26	-121.44	-125.59	-110.20	-120.65	-117.28	
-3	-115.69	-130.83	-127.67	-119.79	-121.51	-127.37	-108.99	-110.07	-110.39	
-2	-109.47	-122.13	-120.43	-112.93	-117.03	-124.90	-111.11	-117.30	-118.69	
-1	-113.12	-113.92	-115.57	-110.55	-113.13	-114.29	-106.31	-114.92	-121.72	
0 ^{note 4}	-	-	-	-	-	-	-	-	-	
+1	-108.84	-114.17	-112.80	-110.00	-115.20	-114.92	-109.46	-107.00	-110.78	
+2	-116.18	-116.71	-115.37	-121.73	-121.01	-122.66	-109.87	-111.27	-116.38	
+3	-117.68	-125.89	-126.89	-113.51	-119.93	-127.02	-119.01	-111.24	-112.48	
+4	-114.51	-121.14	-120.99	-113.42	-116.08	-116.64	-104.48	-108.40	-124.53	
+5	-123.73	-124.55	-125.43	-115.59	-121.77	-126.29	-107.88	-114.54	-111.04	

Note 3: Reference frequency 20 MHz
 Note 4: All spurs are referenced to carrier signal (n=0).



IF/RF MICROWAVE COMPONENTS • ISO 9001 ISO 14001 AS 9100 CERTIFIED RoHS compliant
 P.O. Box 350166, Brooklyn, New York 11235-0003 (718) 934-4500 Fax (718) 332-4661



The Design Engineers Search Engine finds the model you need, Instantly • For detailed performance specs & shopping online see



Notes: 1. Performance and quality attributes and conditions not expressly stated in this specification sheet are intended to be excluded and do not form a part of this specification sheet. 2. Electrical specifications and performance data contained herein are based on Mini-Circuit's applicable established test performance criteria and measurement instructions. 3. The parts covered by this specification sheet are subject to Mini-Circuits standard limited warranty and terms and conditions (collectively, "Standard Terms"); Purchasers of this part are entitled to the rights and benefits contained therein. For a full statement of the Standard Terms and the exclusive rights and remedies thereunder, please visit Mini-Circuits' website at www.minicircuits.com/MCLStore/terms.jsp.

Typical Performance Curves

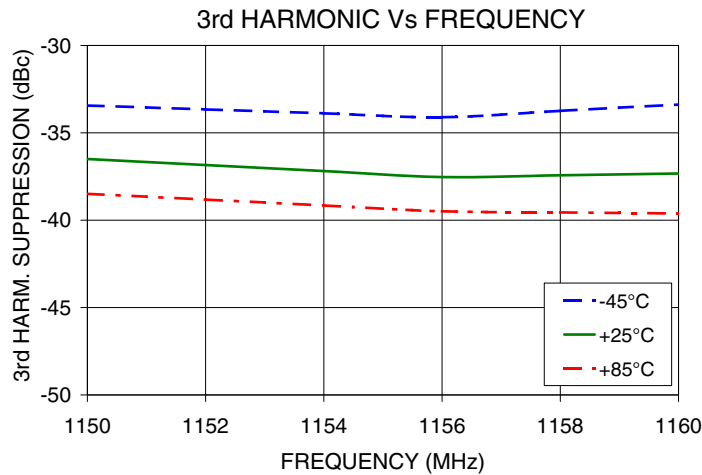
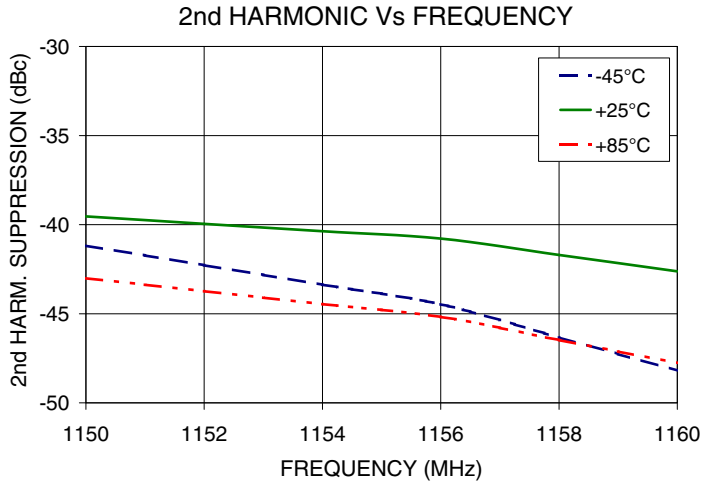
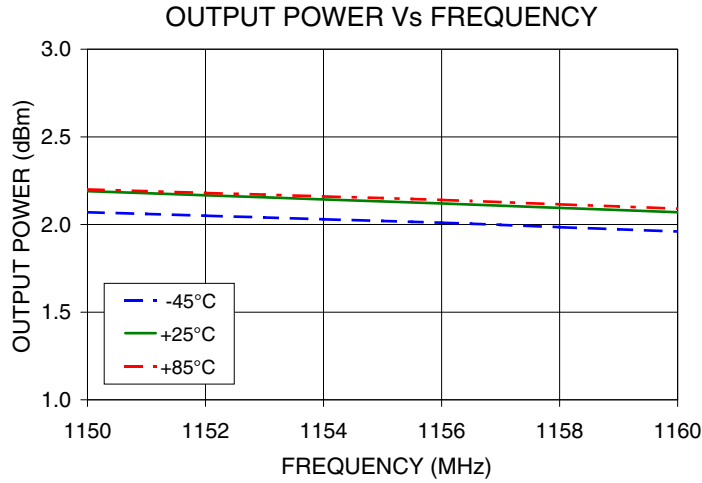

IF/RF MICROWAVE COMPONENTS • ISO 9001 ISO 14001 AS9100 CERTIFIED RoHS compliant
 P.O. Box 350166, Brooklyn, New York 11235-0003 (718) 934-4500 Fax (718) 332-4661



The Design Engineers Search Engine finds the model you need, Instantly • For detailed performance specs & shopping online see



Notes: 1. Performance and quality attributes and conditions not expressly stated in this specification sheet are intended to be excluded and do not form a part of this specification sheet. 2. Electrical specifications and performance data contained herein are based on Mini-Circuit's applicable established test performance criteria and measurement instructions. 3. The parts covered by this specification sheet are subject to Mini-Circuits standard limited warranty and terms and conditions (collectively, "Standard Terms"); Purchasers of this part are entitled to the rights and benefits contained therein. For a full statement of the Standard Terms and the exclusive rights and remedies thereunder, please visit Mini-Circuits' website at www.minicircuits.com/MCLStore/terms.jsp.

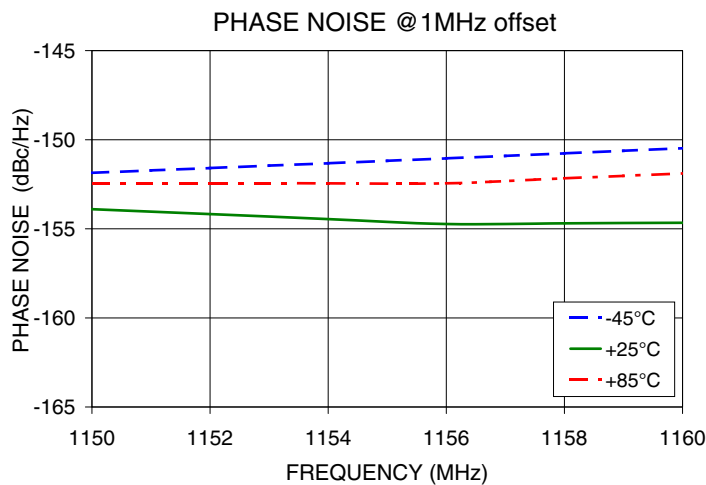
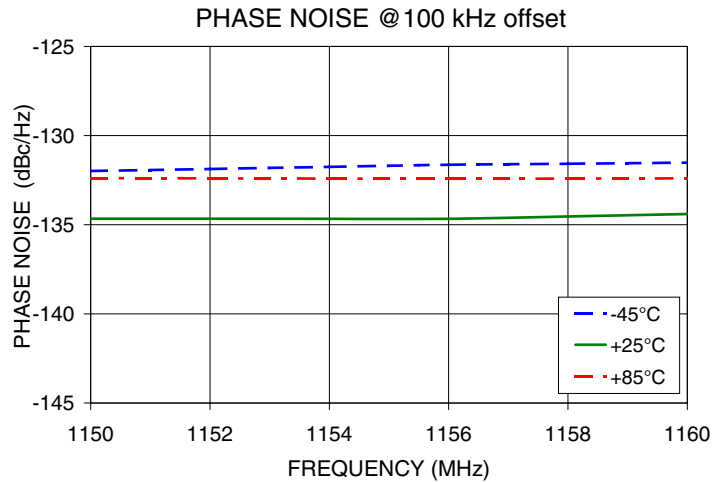
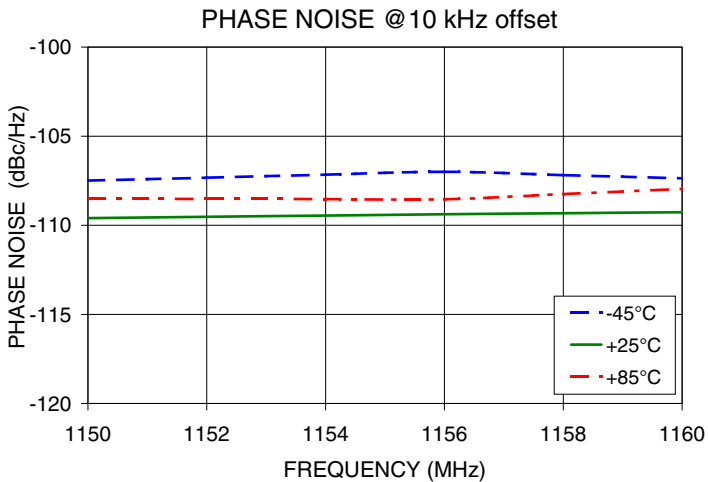
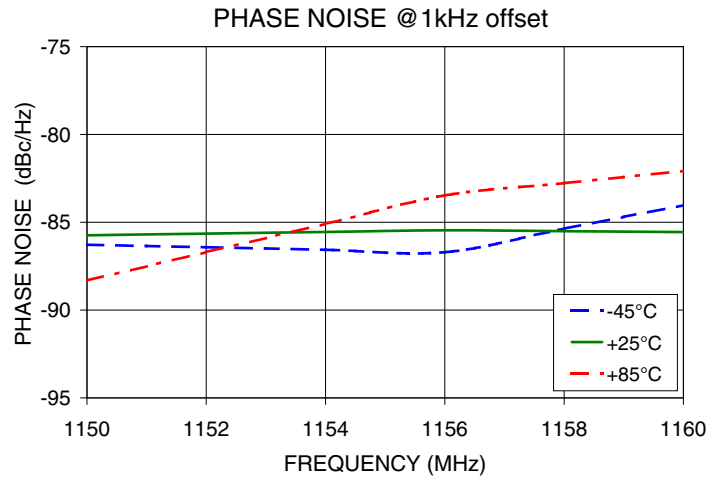
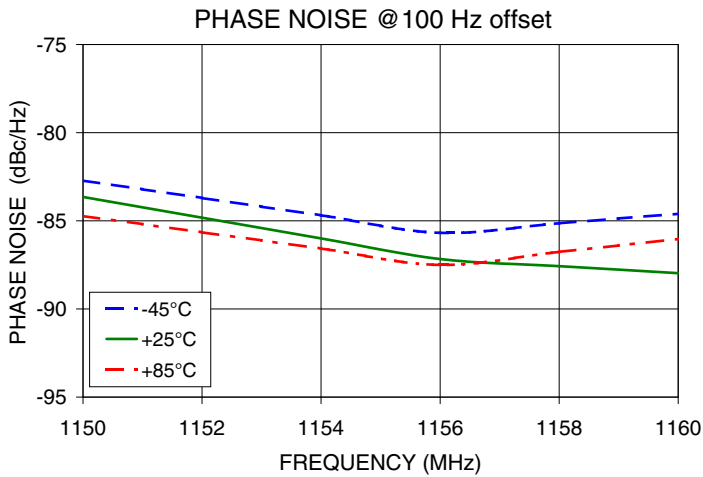

IF/RF MICROWAVE COMPONENTS • ISO 9001 ISO 14001 AS 9100 CERTIFIED RoHS compliant
 P.O. Box 350166, Brooklyn, New York 11235-0003 (718) 934-4500 Fax (718) 332-4661



The Design Engineers Search Engine finds the model you need, Instantly • For detailed performance specs & shopping online see



Notes: 1. Performance and quality attributes and conditions not expressly stated in this specification sheet are intended to be excluded and do not form a part of this specification sheet. 2. Electrical specifications and performance data contained herein are based on Mini-Circuit's applicable established test performance criteria and measurement instructions. 3. The parts covered by this specification sheet are subject to Mini-Circuit's standard limited warranty and terms and conditions (collectively, "Standard Terms"); Purchasers of this part are entitled to the rights and benefits contained therein. For a full statement of the Standard Terms and the exclusive rights and remedies thereunder, please visit Mini-Circuits' website at www.minicircuits.com/MCLStore/terms.jsp.

COMPARISON SPURIOUS
Vs FREQ. OFFSET @ Fcar = 1150MHz

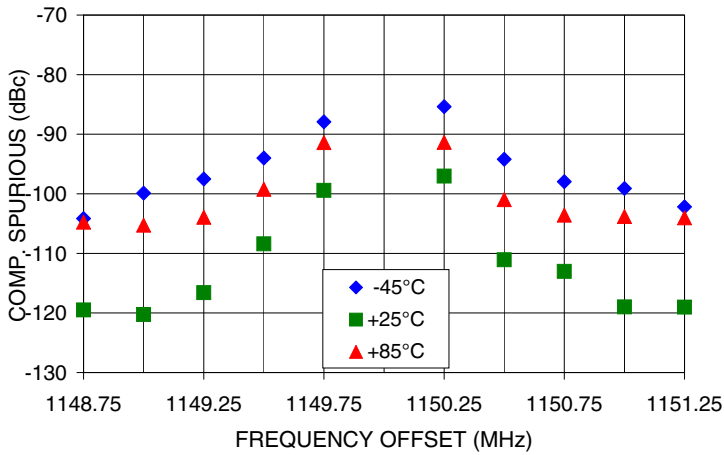

REFERENCE SPURIOUS
Vs FREQ. OFFSET @ Fcar = 1150MHz

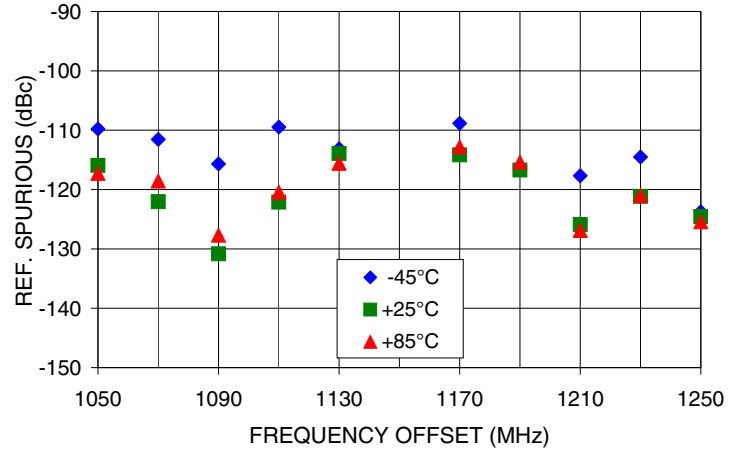

COMPARISON SPURIOUS
Vs FREQ. OFFSET @ Fcar = 1155MHz

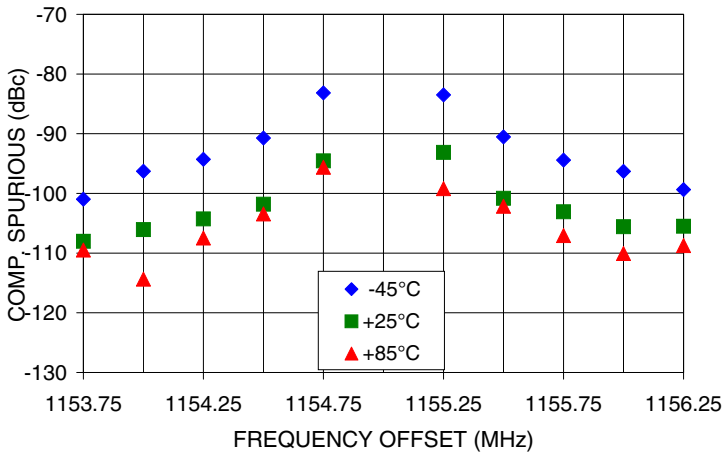

REFERENCE SPURIOUS
Vs FREQ. OFFSET @ Fcar = 1155MHz

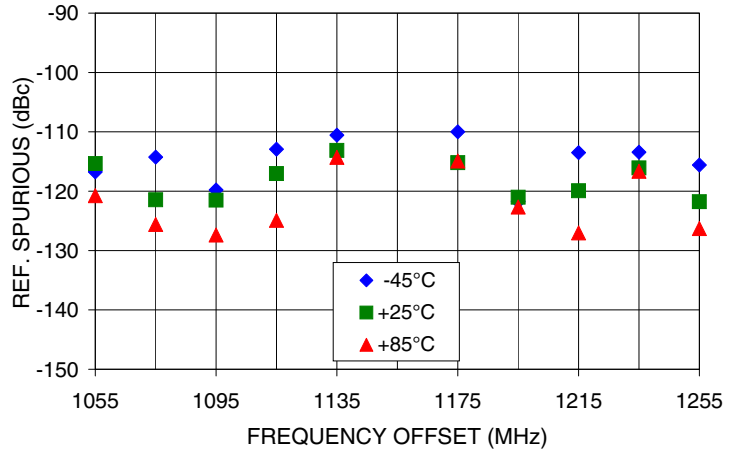

COMPARISON SPURIOUS
Vs FREQ. OFFSET @ Fcar = 1160MHz

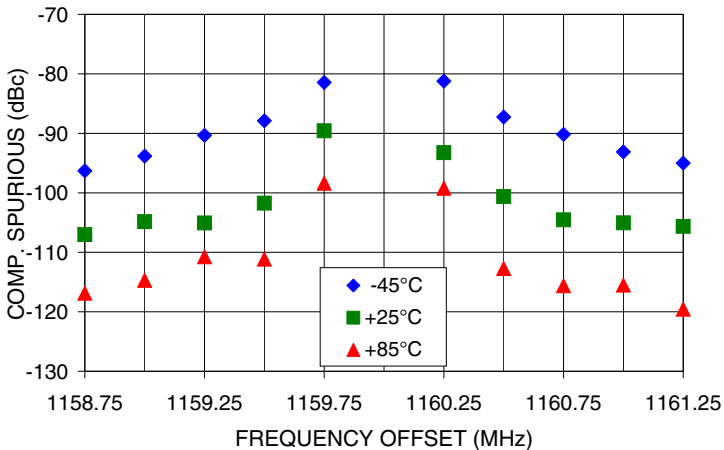

REFERENCE SPURIOUS
Vs FREQ. OFFSET @ Fcar = 1160MHz

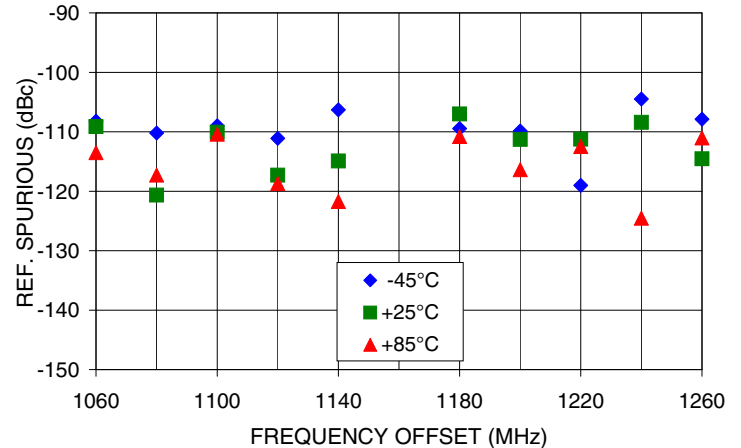

IF/RF MICROWAVE COMPONENTS • ISO 9001 ISO 14001 AS9100 CERTIFIED RoHS compliant
P.O. Box 350166, Brooklyn, New York 11235-0003 (718) 934-4500 Fax (718) 332-4661



The Design Engineers Search Engine finds the model you need, Instantly • For detailed performance specs & shopping online see



Notes: 1. Performance and quality attributes and conditions not expressly stated in this specification sheet are intended to be excluded and do not form a part of this specification sheet. 2. Electrical specifications and performance data contained herein are based on Mini-Circuit's applicable established test performance criteria and measurement instructions. 3. The parts covered by this specification sheet are subject to Mini-Circuits standard limited warranty and terms and conditions (collectively, "Standard Terms"); Purchasers of this part are entitled to the rights and benefits contained therein. For a full statement of the Standard Terms and the exclusive rights and remedies thereunder, please visit Mini-Circuits' website at www.minicircuits.com/MCLStore/terms.jsp.

Pin Configuration

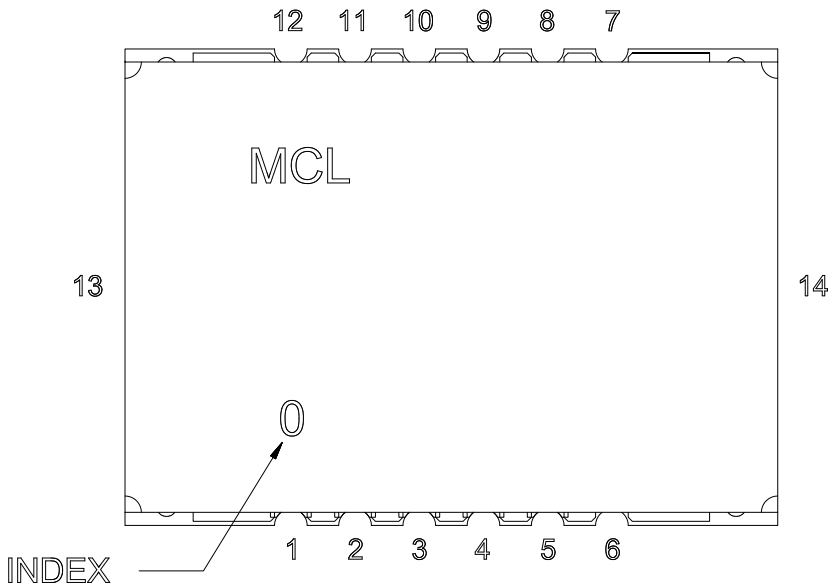

Pin Connection

Pin Number	Function
1	VCC PLL
2	GND
3	REF IN
4	GND
5	VCC VCO
6	GND
7	RF OUT
8	GND
9	LOCK DET
10	CLOCK
11	DATA
12	LE
13	GND
14	GND

Recommended Application Circuit

Note: REF IN and RF OUT ports are internally AC coupled.

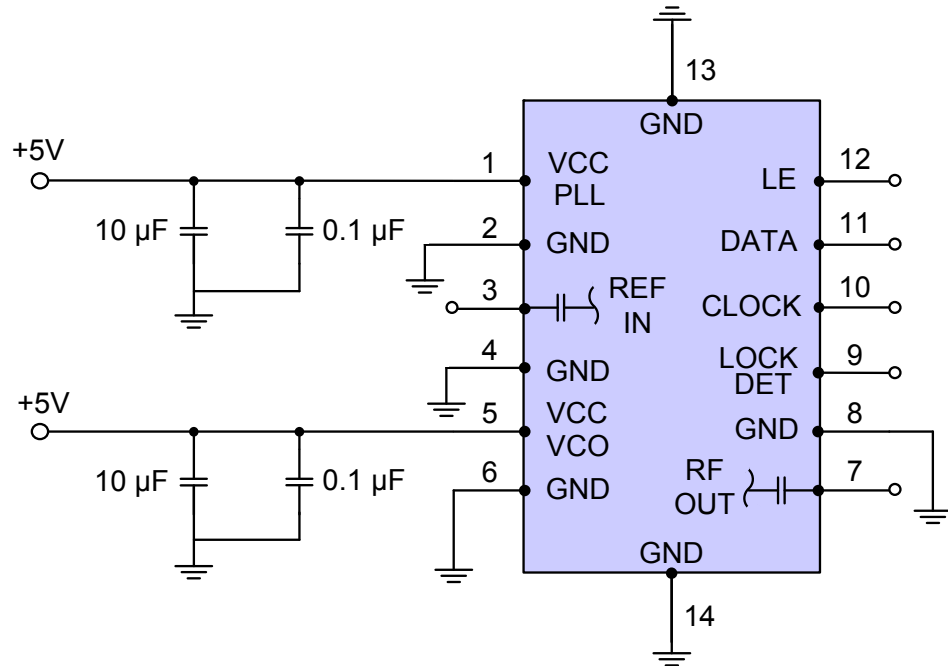

IF/RF MICROWAVE COMPONENTS • ISO 9001 ISO 14001 AS 9100 CERTIFIED RoHS compliant
 P.O. Box 350166, Brooklyn, New York 11235-0003 (718) 934-4500 Fax (718) 332-4661



The Design Engineers Search Engine finds the model you need, Instantly • For detailed performance specs & shopping online see



Notes: 1. Performance and quality attributes and conditions not expressly stated in this specification sheet are intended to be excluded and do not form a part of this specification sheet. 2. Electrical specifications and performance data contained herein are based on Mini-Circuit's applicable established test performance criteria and measurement instructions. 3. The parts covered by this specification sheet are subject to Mini-Circuits standard limited warranty and terms and conditions (collectively, "Standard Terms"); Purchasers of this part are entitled to the rights and benefits contained therein. For a full statement of the Standard Terms and the exclusive rights and remedies thereunder, please visit Mini-Circuits' website at www.minicircuits.com/MCLStore/terms.jsp.

Device Marking

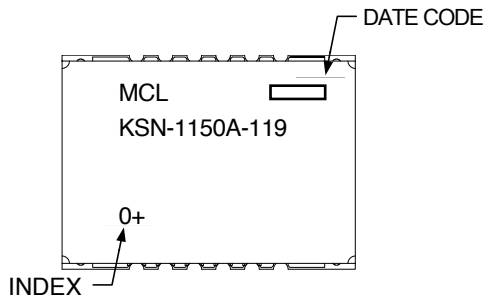

Additional Detailed Technical Information

Additional information is available on our web site. To access this information enter the model number on our web site home page.

Case Style: DK801

Tape & Reel: TR-F28

Suggested Layout for PCB Design: PL-249

Evaluation Board: TB-567+

Environment Ratings: ENV03T2



IF/RF MICROWAVE COMPONENTS • ISO 9001 ISO 14001 AS9100 CERTIFIED RoHS compliant
P.O. Box 350166, Brooklyn, New York 11235-0003 (718) 934-4500 Fax (718) 332-4661



The Design Engineers Search Engine finds the model you need, Instantly • For detailed performance specs & shopping online see



Notes: 1. Performance and quality attributes and conditions not expressly stated in this specification sheet are intended to be excluded and do not form a part of this specification sheet. 2. Electrical specifications and performance data contained herein are based on Mini-Circuit's applicable established test performance criteria and measurement instructions. 3. The parts covered by this specification sheet are subject to Mini-Circuits standard limited warranty and terms and conditions (collectively, "Standard Terms"); Purchasers of this part are entitled to the rights and benefits contained therein. For a full statement of the Standard Terms and the exclusive rights and remedies thereunder, please visit Mini-Circuits' website at www.minicircuits.com/MCLStore/terms.jsp.