

Surface Mount Phase Shifter

50Ω 180° Voltage Variable 300 to 400 MHz

JSPHS-42+

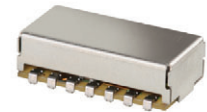

CASE STYLE: BK276
PRICE: \$31.95 ea. QTY. (1-9)

+ RoHS compliant in accordance with EU Directive (2002/95/EC)

The +Suffix has been added in order to identify RoHS Compliance. See our web site for RoHS Compliance methodologies and qualifications.

Maximum Ratings

Operating Temperature	-40°C to 85°C
Storage Temperature	-55°C to 100°C
RF Input Power	20 dBm max.
Control Voltage	20V

Permanent damage may occur if any of these limits are exceeded.

Pin Connections

IN	14
OUT	8
BIAS	1,7^
GROUND	2,3,4,5,6,9,10,11,12,13

^ pins must be connected together externally

Outline Drawing

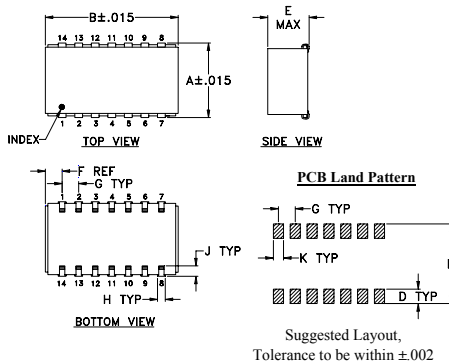

Outline Dimensions (inch mm)

A	B	C	D	E	F	G
.450	.803	--	.100	.250	.102	.100
11.43	20.40	--	2.54	6.35	2.59	2.54

H	J	K	L	wt
.047	.065	.065	.470	grams
1.19	1.65	1.65	11.94	3.0

Demo Board MCL P/N: TB-152+ Suggested PCB Layout (PL-214)

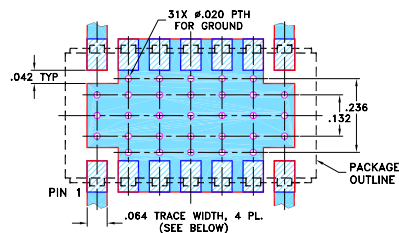

- NOTE: 1. TRACE WIDTH IS SHOWN FOR ROGERS RO4350B WITH DIELECTRIC THICKNESS .030" ± .002"; COPPER: 1/2 OZ. EACH SIDE. FOR OTHER MATERIALS TRACE WIDTH MAY NEED TO BE MODIFIED.
2. BOTTOM SIDE OF THE PCB IS CONTINUOUS GROUND PLANE.
- DENOTES PCB COPPER LAYOUT WITH SMOBC (SOLDER MASK OVER BARE COPPER)
 - DENOTES COPPER LAND PATTERN FREE OF SOLDER MASK

Features

- low insertion loss, 1.4 dB typ.
- good VSWR, 1.3:1 typ.
- J-leads for excellent solderability and strain relief
- aqueous washable

Applications

- signal processing

Phase Shifter Electrical Specifications

FREQUENCY (MHz)	PHASE RANGE (Degrees)	INSERTION LOSS (dB)		CONTROL VOLTAGE (V)	CONTROL BANDWIDTH (kHz)	VSWR (:1)
	Min.	Typ.	Max.		Typ.	Typ. Max.
300-400	180	1.4	2.8	0-12	DC-50	1.3 1.9

Maximum operating power, 0 dBm

Typical Performance Data

Control Voltage (V)	Phase Shift* (Degrees)			VSWR (:1)			Insertion Loss (dB)		
	300 MHz	350 MHz	400 MHz	300 MHz	350 MHz	400 MHz	300 MHz	350 MHz	400 MHz
0.00	0.01	0.02	0.02	1.30	1.09	1.38	1.14	0.94	1.02
1.00	22.50	13.98	8.78	1.37	1.07	1.34	1.31	1.01	1.03
2.00	46.51	29.67	18.50	1.44	1.08	1.30	1.47	1.10	1.05
3.00	72.10	48.35	30.23	1.49	1.13	1.24	1.57	1.21	1.08
4.00	98.30	70.96	45.18	1.50	1.18	1.18	1.57	1.34	1.13
5.00	123.35	97.49	64.79	1.46	1.22	1.12	1.46	1.43	1.21
6.00	145.56	126.14	90.15	1.40	1.22	1.08	1.31	1.43	1.32
7.00	163.78	153.25	120.11	1.34	1.17	1.08	1.16	1.34	1.41
8.00	177.71	175.50	150.07	1.30	1.12	1.07	1.04	1.22	1.41
9.00	187.93	191.88	174.89	1.26	1.08	1.08	0.96	1.12	1.35
10.00	195.19	203.50	193.48	1.24	1.07	1.12	0.91	1.05	1.29
11.00	200.36	211.60	206.55	1.22	1.07	1.17	0.88	1.00	1.24
12.00	204.05	217.31	215.68	1.21	1.08	1.21	0.85	0.97	1.20

* Normalized at control voltage = 0V

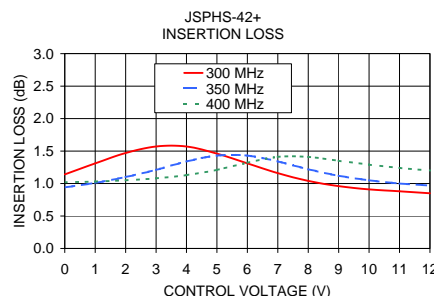
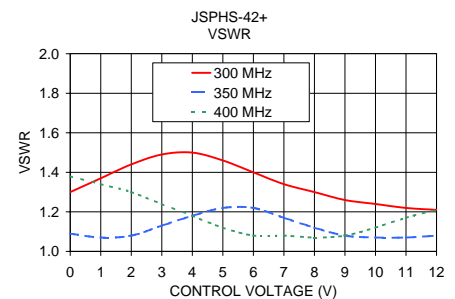
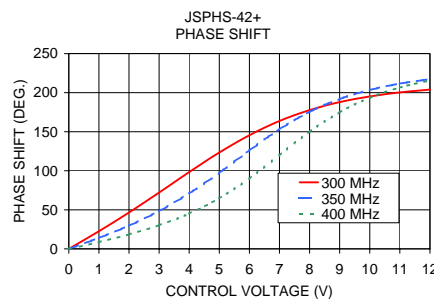

electrical schematic

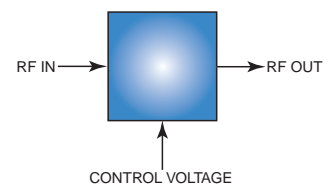

For detailed performance specs & shopping online see web site

Mini-Circuits
ISO 9001 ISO 14001 AS 9100 CERTIFIED

P.O. Box 350166, Brooklyn, New York 11235-0003 (718) 934-4500 Fax (718) 332-4661 The Design Engineers Search Engine Provides ACTUAL Data Instantly at minicircuits.com

Notes: 1. Performance and quality attributes and conditions not expressly stated in this specification sheet are intended to be excluded and do not form a part of this specification sheet. 2. Electrical specifications and performance data contained herein are based on Mini-Circuit's applicable established test performance criteria and measurement instructions. 3. The parts covered by this specification sheet are subject to Mini-Circuit's standard limited warranty and terms and conditions (collectively, "Standard Terms"); Purchasers of this part are entitled to the rights and benefits contained therein. For a full statement of the Standard Terms and the exclusive rights and remedies thereunder, please visit Mini-Circuit's website at www.minicircuits.com/MCLStore/terms.jsp.

REV. OR
M111539
JSPHS-42+
ED-12108B/1
WZ/CP/AM
080415