

High Gain, High IP3

Monolithic Amplifier

GVA-63+

50Ω 0.01 to 6 GHz

The Big Deal

- High Gain
- Broadband High Dynamic Range without external Matching Components
- May be used as a replacement to RFMD SBB5089Z^{a,b}



SOT-89 PACKAGE

Product Overview

GVA-63+ (RoHS compliant) is an wideband amplifier fabricated using InGap HBT technology and offers high gain over a broad frequency range and with high IP3. In addition, the GVA-63+, has good input and output return loss over a broad frequency range without the need for external matching components and has demonstrated excellent reliability. Lead finish is SnAgNi. It has repeatable performance from lot to lot and is enclosed in a SOT-89 package for very good thermal performance.

Key Features

Feature	Advantages
Broad Band: 0.01 to 6.0 GHz	Broadband covering primary wireless communications bands: Cellular, PCS, LTE, WiMAX
Flat gain	High gain reduces number of gain stages, at lower real estate, component count and cost. ± 1.7 dB from 50 MHz to 3 GHz
High IP3 Versus DC power Consumption 34 dBm typical at 0.05 GHz 35 dBm typical at 0.8 GHz	The GVA-63+ matches industry leading IP3 performance relative to device size and power consumption. The combination of the design and InGap HBT Structure provides enhanced linearity over a broad frequency range as evidence in the IP3 being typically 16 dB above the P 1dB point to 0.8 GHz. This feature makes this amplifier ideal for use in: <ul style="list-style-type: none">• Driver amplifiers for complex waveform up converter paths• Drivers in linearized transmit systems
No External Matching Components Required	GVA-63+ provides Input and Output Return Loss of 12-25 dB up to 6 GHz without the need for any external matching components

Notes:

a. Suitability for model replacement within a particular system must be determined by and is solely the responsibility of the customer based on, among other things, electrical performance criteria, stimulus conditions, application, compatibility with other components and environmental conditions and stresses.

b. The RFMD SBB-5089Z part number is used for identification and comparison purposes only.

* X-parameters is a registered trademark of Agilent Technologies, Inc. The X-parameters format and underlying equations are open and documented. For more information, refer to [X-parameters Open Documentation](#), [Trademark Usage & Partnerships](#)

Notes

A. Performance and quality attributes and conditions not expressly stated in this specification document are intended to be excluded and do not form a part of this specification document.
B. Electrical specifications and performance data contained in this specification document are based on Mini-Circuit's applicable established test performance criteria and measurement instructions.
C. The parts covered by this specification document are subject to Mini-Circuits standard limited warranty and terms and conditions (collectively, "Standard Terms"); Purchasers of this part are entitled to the rights and benefits contained therein. For a full statement of the Standard Terms and the exclusive rights and remedies thereunder, please visit Mini-Circuits' website at www.minicircuits.com/MCLStore/terms.jsp



High Gain, High IP3

Monolithic Amplifier

0.01-6 GHz

Product Features

- Gain, 21 dB typ. at 0.8 GHz
- Flat Gain, ± 1.7 , 50 to 4000 MHz
- High Pout, P1dB 19.0 dBm typ. at 0.8 GHz
- High IP3, 35 dBm typ. at 0.8 GHz
- Excellent ESD protection, Class 1C for HBM
- No external matching components required
- May be used as replacement for RFMD SBB5089Z^{a,b}

Typical Applications

- Base station infrastructure
- Portable Wireless
- CATV & DBS
- MMDS & Wireless LAN
- LTE

General Description

GVA-63+ (RoHS compliant) is an advanced wideband amplifier fabricated using InGaP HBT technology and offers high gain over a broad frequency range and with high IP3. In addition, the GVA-63+ has good input and output return loss over a broad frequency range without the need for external matching components. Lead finish is SnAgNi. It has repeatable performance from lot to lot and is enclosed in a SOT-89 package for very good thermal performance.



CASE STYLE: DF782
PRICE: \$0.99 ea. QTY. (20)

GVA-63+

+RoHS Compliant

The +Suffix identifies RoHS Compliance. See our web site for RoHS Compliance methodologies and qualifications

simplified schematic and pin description

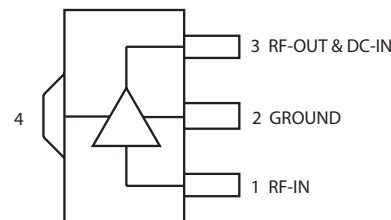
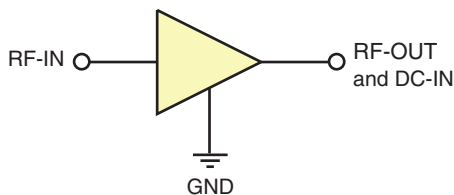

Function	Pin Number	Description
RF IN	1	RF input pin. This pin requires the use of an external DC blocking capacitor chosen for the frequency of operation.
RF-OUT and DC-IN	3	RF output and bias pin. DC voltage is present on this pin; therefore a DC blocking capacitor is necessary for proper operation. An RF choke is needed to feed DC bias without loss of RF signal due to the bias connection, as shown in "Recommended Application Circuit", Fig. 2
GND	2,4	Connections to ground. Use via holes as shown in "Suggested Layout for PCB Design" to reduce ground path inductance for best performance.

Notes:

- a. Suitability for model replacement within a particular system must be determined by and is solely the responsibility of the customer based on, among other things, electrical performance criteria, stimulus conditions, application, compatibility with other components and environmental conditions and stresses.
- b. The RFMD SBB5089Z part number is used for identification and comparison purposes only.

Notes

- A. Performance and quality attributes and conditions not expressly stated in this specification document are intended to be excluded and do not form a part of this specification document.
- B. Electrical specifications and performance data contained in this specification document are based on Mini-Circuit's applicable established test performance criteria and measurement instructions.
- C. The parts covered by this specification document are subject to Mini-Circuits standard limited warranty and terms and conditions (collectively, "Standard Terms"); Purchasers of this part are entitled to the rights and benefits contained therein. For a full statement of the Standard Terms and the exclusive rights and remedies thereunder, please visit Mini-Circuits' website at www.minicircuits.com/MCLStore/terms.jsp



Electrical Specifications^{1,2} at 25°C, unless noted

Parameter	Condition (GHz)	Min.	Typ.	Max.	Units
Frequency Range ²		0.01		6	GHz
Gain	0.05	19.0	21.9		dB
	0.8		21.1		
	2.0		19.9		
	3.0		18.5		
	4.0		17.3		
	6.0		15.9		
Gain Flatness	0.05 - 3.0		±1.7		dB
	0.7 - 2.6		±1.3		
Input Return Loss	0.05	14.0	17.6		dB
	0.8		19.7		
	2.0		25.0		
	3.0		25.8		
	4.0		20.0		
	6.0		12.0		
Output Return Loss	0.05	14.0	14.5		dB
	0.8		20.6		
	2.0		16.6		
	3.0		16.5		
	4.0		17.1		
	6.0		13.8		
Reverse Isolation	2.0		23.7		dB
Output Power @ 1 dB compression	0.05	17.0	18.7		dBm
	0.8		18.9		
	2.0		18.6		
	3.0		16.9		
	4.0		15.7		
	6.0		11.8		
Output IP3	0.05		33.5		dB
	0.8		34.8		
	2.0		32.2		
	3.0		28.6		
	4.0		26.6		
	6.0		25.0		
Noise Figure	0.05		3.6		dB
	0.8		3.8		
	2.0		3.7		
	3.0		3.7		
	4.0		4.0		
	6.0		4.6		
Device Operating Voltage		4.8	5.0	5.2	V
Device Operating Current		58	69	78	mA
Device Current Variation vs. Temperature ³			61		µA/°C
Device Current Variation vs. Voltage			0.040		mA/mV
Thermal Resistance, junction-to-ground lead			91		°C/W

⁽¹⁾ Measured on Mini-Circuits Characterization test board TB-313. See Characterization Test Circuit (Fig. 1)

⁽²⁾ Low Frequency cut-off determined by external coupling capacitors and external bias choke.

⁽³⁾ Current at 85°C — Current at -45°C/130

Absolute Maximum Ratings

Parameter	Ratings
Operating Temperature (ground lead)	-40°C to 85°C
Storage Temperature	-65°C to 150°C
Operating Current at 5V	100 mA
Power Dissipation	0.5 W
Input Power (CW)	13 dBm
DC Voltage on Pin 3	5.7 V

Note:

Permanent damage may occur if any of these limits are exceeded. Electrical maximum ratings are not intended for continuous normal operation.

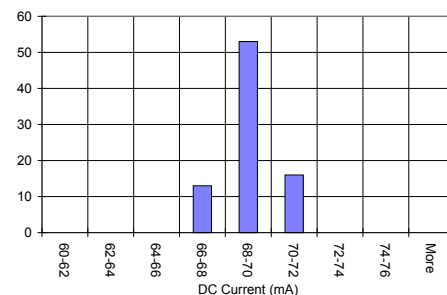

Notes

- A. Performance and quality attributes and conditions not expressly stated in this specification document are intended to be excluded and do not form a part of this specification document.
- B. Electrical specifications and performance data contained in this specification document are based on Mini-Circuit's applicable established test performance criteria and measurement instructions.
- C. The parts covered by this specification document are subject to Mini-Circuits standard limited warranty and terms and conditions (collectively, "Standard Terms"); Purchasers of this part are entitled to the rights and benefits contained therein. For a full statement of the Standard Terms and the exclusive rights and remedies thereunder, please visit Mini-Circuits' website at www.minicircuits.com/MCLStore/terms.jsp



Characterization Test Circuit

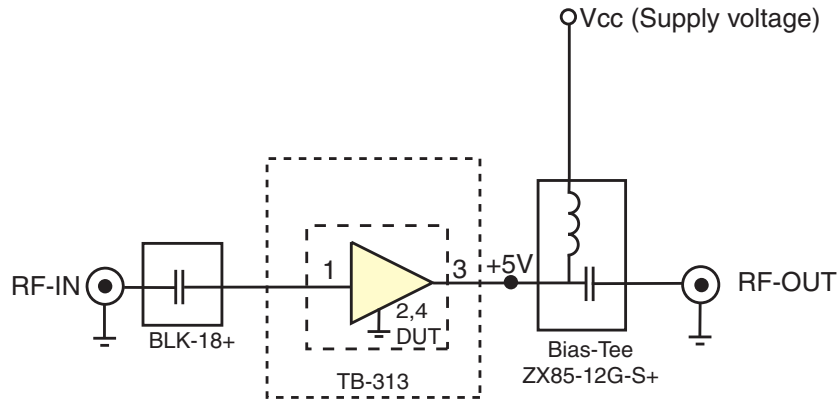

Fig 1. Block Diagram of Test Circuit used for characterization. (DUT soldered on Mini-Circuits Characterization test board TB-313)
Gain, Return loss, Output power at 1dB compression (P1 dB) , output IP3 (OIP3) and noise figure measured using Agilent's N5242A PNA-X microwave network analyzer.

Conditions:
 1. Gain and Return loss: Pin= -25dBm
 2. Output IP3 (OIP3): Two tones, spaced 1 MHz apart, 0 dBm/tone at output.

Recommended Application Circuit

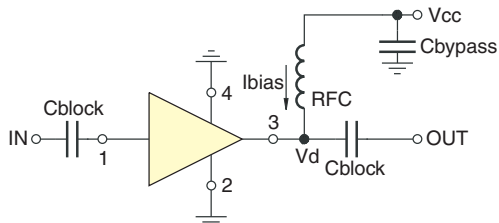
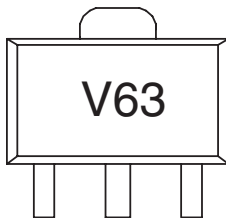

Fig 2. Test Board includes case, connectors, and components soldered to PCB

Product Marking



Notes
 A. Performance and quality attributes and conditions not expressly stated in this specification document are intended to be excluded and do not form a part of this specification document.
 B. Electrical specifications and performance data contained in this specification document are based on Mini-Circuit's applicable established test performance criteria and measurement instructions.
 C. The parts covered by this specification document are subject to Mini-Circuits standard limited warranty and terms and conditions (collectively, "Standard Terms"); Purchasers of this part are entitled to the rights and benefits contained therein. For a full statement of the Standard Terms and the exclusive rights and remedies thereunder, please visit Mini-Circuits' website at www.minicircuits.com/MCLStore/terms.jsp

Additional Detailed Technical Information	
<i>additional information is available on our dash board. To access this information click here</i>	
Performance Data	Data Table
	Swept Graphs
	S-Parameter (S2P Files) Data Set (.zip file)
Case Style	DF782 (SOT 89) <i>Plastic package, exposed paddle, lead finish: tin-silver over nickel</i>
Tape & Reel Standard quantities available on reel	F55 <i>7" reels with 20, 50, 100, 200, 500 or 1K devices</i>
Suggested Layout for PCB Design	PL-255
Evaluation Board	TB-410-63+
Environmental Ratings	ENV08T1

ESD Rating

Human Body Model (HBM): Class 1C (1000 to <2000V) in accordance with ANSI/ESD STM 5.1 - 2001

Machine Model (MM): Class M2 (100 to <200V) in accordance with ANSI/ESD STM5.2-1999

MSL Rating

Moisture Sensitivity: MSL1 in accordance with IPC/JEDEC J-STD-020D

MSL Test Flow Chart

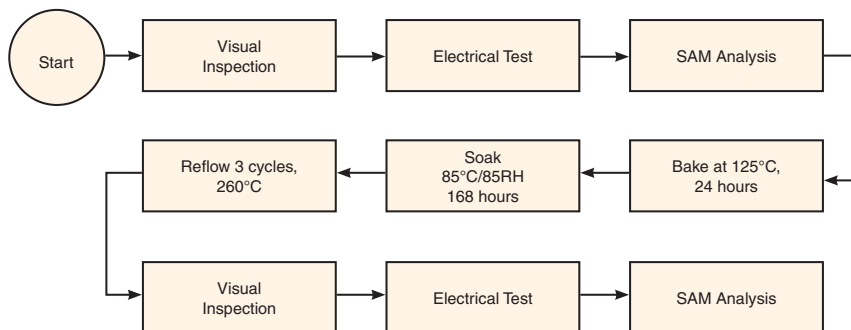

Notes

- A. Performance and quality attributes and conditions not expressly stated in this specification document are intended to be excluded and do not form a part of this specification document.
- B. Electrical specifications and performance data contained in this specification document are based on Mini-Circuit's applicable established test performance criteria and measurement instructions.
- C. The parts covered by this specification document are subject to Mini-Circuits standard limited warranty and terms and conditions (collectively, "Standard Terms"); Purchasers of this part are entitled to the rights and benefits contained therein. For a full statement of the Standard Terms and the exclusive rights and remedies thereunder, please visit Mini-Circuits' website at www.minicircuits.com/MCLStore/terms.jsp

