

Surface Mount

Diplexer

DPLB-2025A0+

75Ω DC to 1220 MHz
(DC-204, 258-1220 MHz)



CASE STYLE: NU1620

The Big Deal

- Low insertion loss, 1dB Typ.
- High rejection
- High crossover isolation
- Excellent return loss, 24dB Typ.
- 75Ω Impedance
- Used in DOCSIS 3.1 standard

Product Overview

DPLB-2025A0+ is a Low cost high performance diplexer with the lowpass port at DC-204 MHz and high-pass port at 258-1220 MHz. Excellent return loss combined with high out of channel rejection makes it a ideal component in cable TV and multiband radio systems.

Key Features

Feature	Advantages
Low passband insertion loss	Passband insertion loss 1dB ensures low signal loss through both the channels.
Excellent Stopband rejection	Co-channel rejection of 50dB ensures unwanted spurious are eliminated.
Excellent return loss at DC-204 and 258-1220 MHz	This makes signal transmission with very less reflection and well-matched with the adjacent component used in the system.

Notes

- A. Performance and quality attributes and conditions not expressly stated in this specification document are intended to be excluded and do not form a part of this specification document.
B. Electrical specifications and performance data contained in this specification document are based on Mini-Circuit's applicable established test performance criteria and measurement instructions.
C. The parts covered by this specification document are subject to Mini-Circuits standard limited warranty and terms and conditions (collectively, "Standard Terms"); Purchasers of this part are entitled to the rights and benefits contained therein. For a full statement of the Standard Terms and the exclusive rights and remedies thereunder, please visit Mini-Circuits' website at www.minicircuits.com/MCLStore/terms.jsp



Surface Mount Diplexer

DPLB-2025A0+

75Ω DC to 1220 MHz (DC-204, 258-1220 MHz)



CASE STYLE: NU1620

+RoHS Compliant
The +Suffix identifies RoHS Compliance. See our web site for RoHS Compliance methodologies and qualifications

Maximum Ratings

Operating Temperature	-40° to 85°C
Storage Temperature	-55°C to 100°C
RF Power Input	27dBm Max.

Permanent damage may occur if any of these limits are exceeded. These ratings are not intended for continuous normal operation

Pin Connections

HIGH PASS PORT	7
LOW PASS PORT	9
COMMON PORT	18
GROUND	1-6,8,10-17,19,20

Features

- Low insertion loss
- Excellent return loss
- High rejection
- High crossover isolation
- 75Ω Impedance

Applications

- Cable TV systems (DOCSIS 3.1 standard)
- Multiband radio systems

Electrical Specifications at 25°C

Parameter	Port	Frequency (MHz)	Min.	Typ.	Max.	Unit	
Pass Band	Insertion Loss	Low Pass	DC-204	-	1	1.5	dB
		High Pass	258-1220	-	1	1.5	
	Return Loss	Low Pass	DC-204	20	24	-	dB
			High Pass	258-1000	18	24	
		Common	DC-204	20	24	-	
			258-1000	17	20	-	
Stop Band Isolation	Low Pass	258-1220	44	50	-	dB	
	High Pass	DC-204	48	55	-		
Cross Over Isolation	LP-HP	204-258	35	40	-		

Typical Performance Data at 25°C

FREQUENCY (MHz)	INSERTION LOSS (dB)			RETURN LOSS (dB)	
	Low Pass Port	High Pass Port	Common Port	Low Pass Port	High Pass Port
1.0	0.00	88.86	50.81	51.27	0.00
5.0	0.06	82.40	41.58	41.60	0.05
10.0	0.09	77.89	36.58	36.90	0.06
45.0	0.17	67.33	25.74	26.76	0.09
60.0	0.20	68.18	24.29	25.21	0.10
85.0	0.24	71.36	24.18	24.34	0.13
100.0	0.26	73.36	25.78	24.97	0.17
200.0	0.84	87.09	30.46	28.27	0.70
204.0	0.95	60.60	30.15	38.25	0.73
214.0	2.28	45.89	9.44	9.22	0.84
216.0	3.21	43.41	6.91	6.54	0.87
221.0	7.53	30.88	3.13	2.59	0.95
226.0	14.16	20.82	1.93	1.26	1.12
230.0	20.47	14.67	1.84	0.92	1.41
235.0	29.89	8.52	2.62	0.74	2.37
241.0	43.78	3.75	5.72	0.65	5.54
245.0	47.24	2.19	9.40	0.61	9.23
258.0	54.91	0.94	28.30	0.53	27.96
300.0	63.81	0.57	25.98	0.40	25.01
750.0	54.50	0.40	31.86	0.07	32.33
1000.0	52.90	0.51	25.52	0.17	24.17
1220.0	52.16	0.53	20.67	0.41	23.89

Functional Schematic

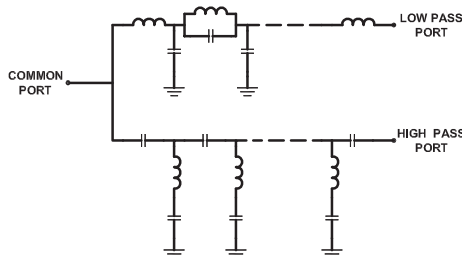

Outline Drawing

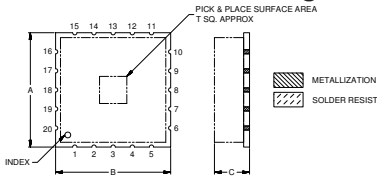

PCB Land Pattern

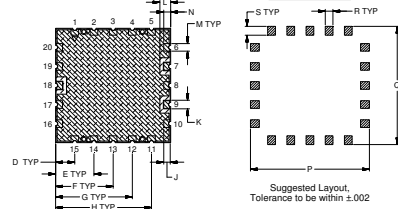

Outline Dimensions (inch/mm)

A	B	C	D	E	F	G	H	J	K	
-	-	Max	Min							
1.181	1.181	.280	.205	.197	.394	.591	.787	.984	.066	.089
30.00	30.00	7.11	5.21	5.00	10.00	15.00	20.00	25.00	1.68	2.26
	L	M	N	P	Q	R	S	T		Wt.
										grams
	.111	.079	.071	1.221	1.221	.079	.091	.280		3.6
	2.82	2.01	1.80	31.01	31.01	2.01	2.31	7.11		

Demo Board MCL P/N: TB-786+ Suggested PCB Layout (PL-435)

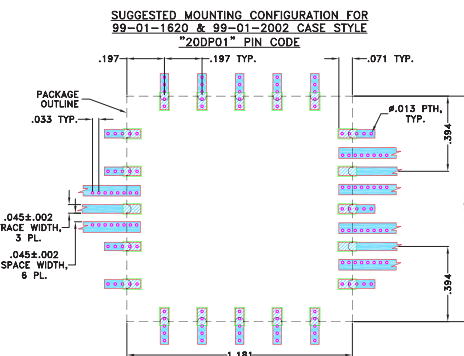

NOTES:

1. TRACE WIDTH IS SHOWN FOR OAK-602 WITH DIELECTRIC THICKNESS .031"±.002". COPPER: 1/2 OZ. EACH SIDE. FOR OTHER MATERIALS TRACE WIDTH MAY NEED TO BE MODIFIED.
 2. BOTTOM SIDE OF THE PCB IS CONTINUOUS GROUND PLANE.
-

Notes

- A. Performance and quality attributes and conditions not expressly stated in this specification document are intended to be excluded and do not form a part of this specification document.
- B. Electrical specifications and performance data contained in this specification document are based on Mini-Circuits' applicable established test performance criteria and measurement instructions.
- C. The parts covered by this specification document are subject to Mini-Circuits' standard limited warranty and terms and conditions (collectively, "Standard Terms"); Purchasers of this part are entitled to the rights and benefits contained therein. For a full statement of the Standard Terms and the exclusive rights and remedies thereunder, please visit Mini-Circuits' website at www.minicircuits.com/MCLStore/terms.jsp



www.minicircuits.com P.O. Box 350166, Brooklyn, NY 11235-0003 (718) 934-4500 sales@minicircuits.com

REV. OR
M156476
EDU2223/1
DPLB-2025A0+
URJ
160818
Page 2 of 3

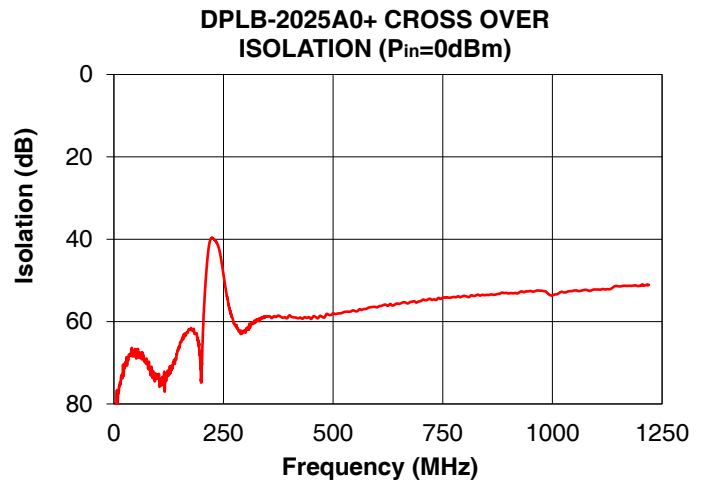
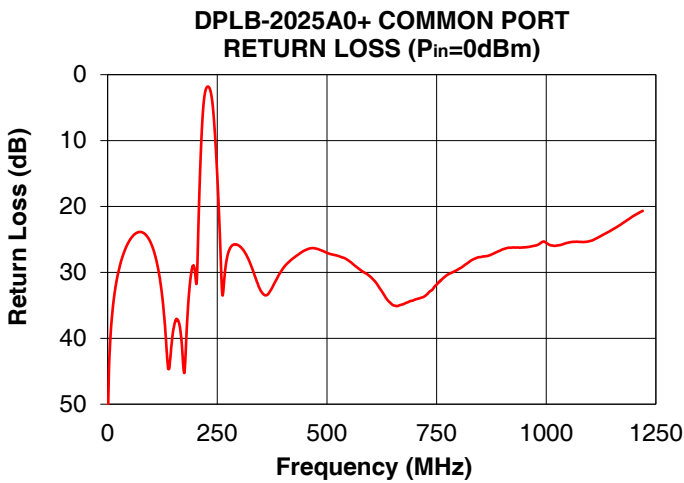
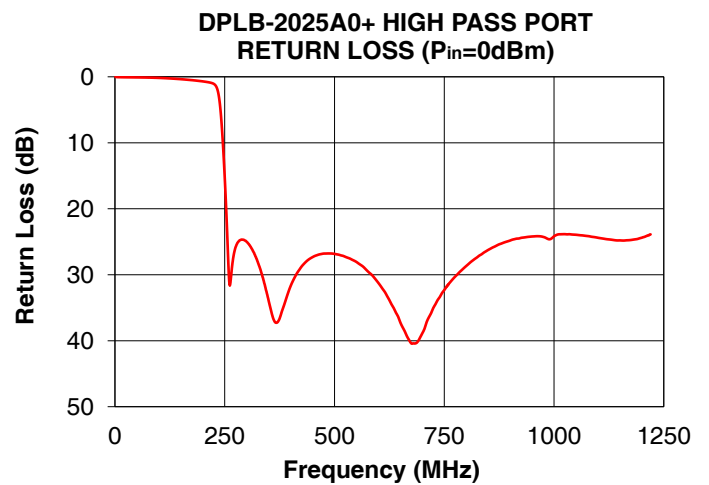
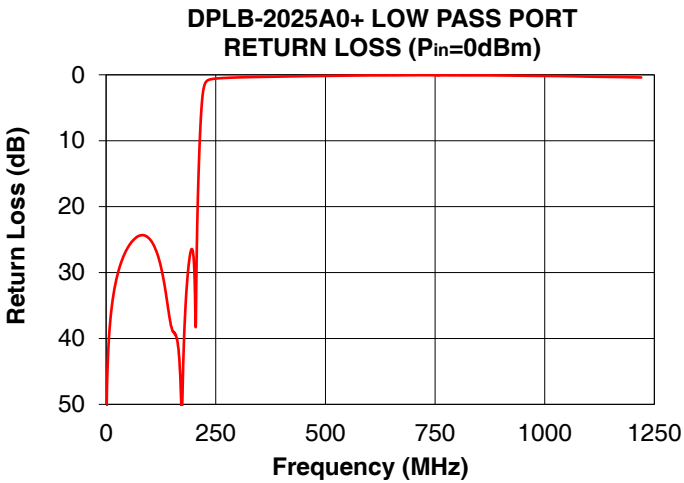
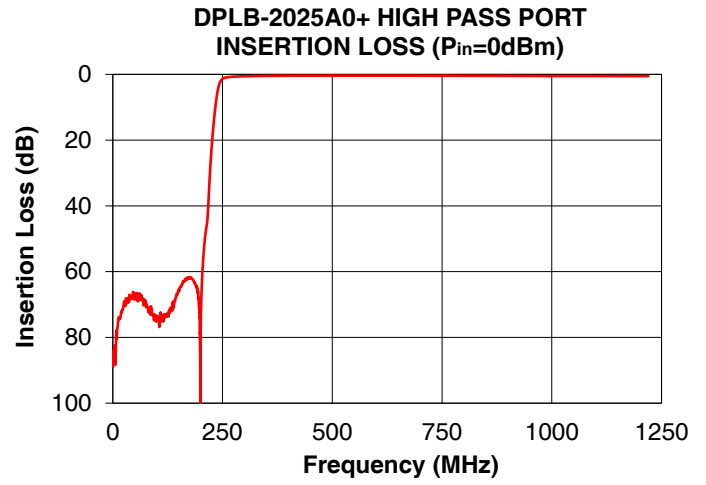
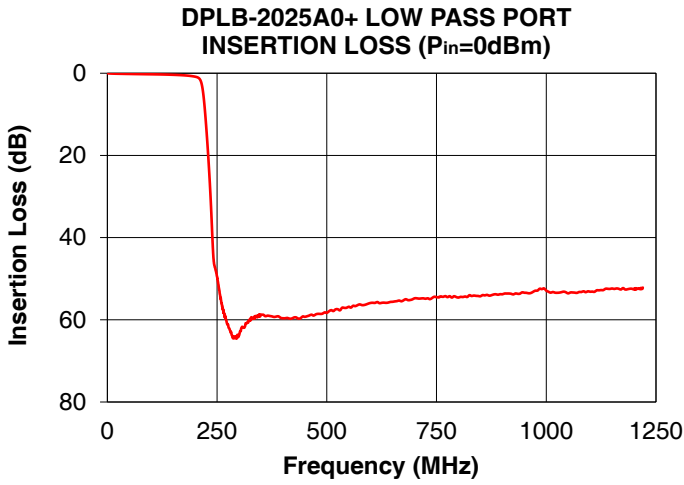

Notes

- A. Performance and quality attributes and conditions not expressly stated in this specification document are intended to be excluded and do not form a part of this specification document.
- B. Electrical specifications and performance data contained in this specification document are based on Mini-Circuits' applicable established test performance criteria and measurement instructions.
- C. The parts covered by this specification document are subject to Mini-Circuits standard limited warranty and terms and conditions (collectively, "Standard Terms"); Purchasers of this part are entitled to the rights and benefits contained therein. For a full statement of the Standard Terms and the exclusive rights and remedies thereunder, please visit Mini-Circuits' website at www.minicircuits.com/MCLStore/terms.jsp

