

# Digital Step Attenuator

50Ω DC-4000 MHz

15.5 dB, 0.5 dB Step

5 Bit, Serial Control Interface, Single Positive Supply Voltage, +3V

## Product Features

- Single positive supply voltage, +3V
- Immune to latch up
- Excellent accuracy, 0.1 dB Typ
- Serial control interface
- Low Insertion Loss
- High IP3, +52 dBm typ
- Very low DC power consumption
- Excellent return loss, 20 dB Typ
- Small size 4.0 x 4.0 mm

## Typical Applications

- Base Station Infrastructure
- Portable Wireless
- CATV & DBS
- MMDS & Wireless LAN
- Wireless Local Loop
- UNII & Hiper LAN
- Power amplifier distortion canceling loops

## General Description

The DAT-15R5-SP is a 50Ω RF digital step attenuator that offers an attenuation range up to 15.5 dB in 0.5 dB steps. The control is a 5-bit serial interface, operating on a single +3 volt supply. The DAT-15R5-SP is produced using a unique CMOS process on silicon, offering the performance of GaAs, with the advantages of conventional CMOS devices.

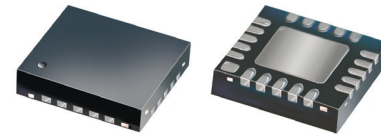

**DAT-15R5-SP+**  
**DAT-15R5-SP**

CASE STYLE: DG983-1  
PRICE: \$3.55 ea. QTY. (10-24)

+ RoHS compliant in accordance  
with EU Directive (2002/95/EC)

*The +Suffix identifies RoHS Compliance. See our web site for  
RoHS Compliance methodologies and qualifications.*

## Simplified Schematic

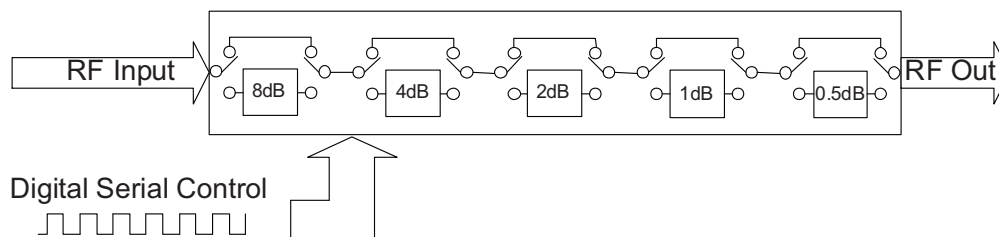

**Mini-Circuits®**  
ISO 9001 ISO 14001 AS 9100 CERTIFIED

P.O. Box 350166, Brooklyn, New York 11235-0003 (718) 934-4500 Fax (718) 332-4661 *The Design Engineers Search Engine*  Provides ACTUAL Data Instantly at [minicircuits.com](http://minicircuits.com)

For detailed performance specs  
& shopping online see web site

IF/RF MICROWAVE COMPONENTS

**Notes:** 1. Performance and quality attributes and conditions not expressly stated in this specification sheet are intended to be excluded and do not form a part of this specification sheet. 2. Electrical specifications and performance data contained herein are based on Mini-Circuit's applicable established test performance criteria and measurement instructions. 3. The parts covered by this specification sheet are subject to Mini-Circuits standard limited warranty and terms and conditions (collectively, "Standard Terms"); Purchasers of this part are entitled to the rights and benefits contained therein. For a full statement of the Standard Terms and the exclusive rights and remedies thereunder, please visit Mini-Circuits' website at [www.minicircuits.com/MCLStore/terms.jsp](http://www.minicircuits.com/MCLStore/terms.jsp).

REV. F  
M126943  
DAT-15R5-SP  
100411  
Page 1 of 12

# Digital Step Attenuator

**DAT-15R5-SP+**  
**DAT-15R5-SP**

## RF Electrical Specifications, DC-4000 MHz, T<sub>AMB</sub>=25°C, V<sub>DD</sub>=+3V

| Parameter  | Freq. Range (GHz) | Min. | Typ. | Max. | Units |
|--|-------------------|------|------|------|-------|
| Accuracy @ 0.5 dB Attenuation Setting  | DC-1              | —    | 0.03 | 0.1  | dB    |
|  | 1-2.2             | —    | 0.05 | 0.15 | dB    |
|  | 2.2-4.0           | —    | 0.1  | 0.3  | dB    |
| Accuracy @ 1 dB Attenuation Setting  | DC-1              | —    | 0.02 | 0.1  | dB    |
|  | 1-2.2             | —    | 0.05 | 0.15 | dB    |
|  | 2.2-4.0           | —    | 0.1  | 0.3  | dB    |
| Accuracy @ 2 dB Attenuation Setting  | DC-1              | —    | 0.05 | 0.15 | dB    |
|  | 1-2.2             | —    | 0.15 | 0.25 | dB    |
|  | 2.2-4.0           | —    | 0.2  | 0.45 | dB    |
| Accuracy @ 4 dB Attenuation Setting  | DC-1              | —    | 0.07 | 0.2  | dB    |
|  | 1-2.2             | —    | 0.15 | 0.25 | dB    |
|  | 2.2-4.0           | —    | 0.18 | 0.45 | dB    |
| Accuracy @ 8 dB Attenuation Setting  | DC-1              | —    | 0.03 | 0.2  | dB    |
|  | 1-2.2             | —    | 0.15 | 0.25 | dB    |
|  | 2.2-4.0           | —    | 0.5  | 0.8  | dB    |
| Insertion Loss <sup>(note1)</sup> @ all attenuator set to 0dB                      | DC-1              | —    | 1.3  | 1.9  | dB    |
|  | 1-2.2             | —    | 1.1  | 2.5  | dB    |
|  | 2.2-4.0           | —    | 3.3  | 4.7  | dB    |
| Input IP3 <sup>(note 2)</sup> (at Min. and Max. Attenuation)                       | DC-2.2            | —    | +52  | —    | dBm   |
|  | 2.2-4.0           | —    | +42  | —    | dBm   |
| Input Power @ 0.2dB Compression <sup>(note 2)</sup> (at Min. and Max. Attenuation) | DC-4.0            | —    | +24  | —    | dBm   |
| VSWR   | DC-1              | —    | 1.2  | 1.5  | —     |
|  | 1-2.2             | —    | 1.2  | 1.5  | —     |
|  | 2.2-4.0           | —    | 1.8  | 2.1  | —     |

### Notes:

1. Loss values are de-embedded from test board Loss (test board's Insertion Loss: 0.10dB @100MHz, 0.35dB @1000MHz, 0.60dB @2200MHz, 0.75dB @4000MHz, 1.5dB @6000MHz)
2. Input IP3 and 1dB compression degrades below 1 MHz

## DC Electrical Specifications

| Parameter                        | Min.                | Typ. | Max.                | Units |
|----------------------------------|---------------------|------|---------------------|-------|
| V <sub>DD</sub> , Supply Voltage | 2.7                 | 3    | 3.3                 | V     |
| I <sub>DD</sub> , Supply Current | —                   | —    | 100                 | μA    |
| Control Input Low                | —                   | —    | 0.3xV <sub>DD</sub> | V     |
| Control Input High               | 0.7xV <sub>DD</sub> | —    | —                   | V     |
| Control Current                  | —                   | —    | 1                   | μA    |

## Switching Specifications

| Parameter  | Min. | Typ. | Max. | Units |
|--|------|------|------|-------|
| Switching Speed, 50% Control to 0.5dB of Attenuation Value | —    | 1.0  | —    | μSec  |
| Switching Control Frequency                                | —    | —    | 25   | KHz   |

## Absolute Maximum Ratings

| Parameter             | Ratings                                |
|-----------------------|--|
| Operating Temperature | -40°C to 85°C                          |
| Storage Temperature   | -55°C to 100°C                         |
| V <sub>DD</sub>       | -0.3V Min., 4V Max.                    |
| Voltage on any input  | -0.3V Min., V <sub>DD</sub> +0.3V Max. |
| ESD, HBM              | 500V                                   |
| ESD, MM               | 100V                                   |
| Input Power           | +24dBm                                 |

Permanent damage may occur if any of these limits are exceeded.



For detailed performance specs & shopping online see web site

P.O. Box 350166, Brooklyn, New York 11235-0003 (718) 934-4500 Fax (718) 332-4661 The Design Engineers Search Engine Provides ACTUAL Data Instantly at [minicircuits.com](http://minicircuits.com)

Notes: 1. Performance and quality attributes and conditions not expressly stated in this specification sheet are intended to be excluded and do not form a part of this specification sheet. 2. Electrical specifications and performance data contained herein are based on Mini-Circuit's applicable established test performance criteria and measurement instructions. 3. The parts covered by this specification sheet are subject to Mini-Circuits standard limited warranty and terms and conditions (collectively, "Standard Terms"); Purchasers of this part are entitled to the rights and benefits contained therein. For a full statement of the Standard Terms and the exclusive rights and remedies thereunder, please visit Mini-Circuits' website at [www.minicircuits.com/MCLStore/terms.jsp](http://www.minicircuits.com/MCLStore/terms.jsp).

## Pin Description

| Function        | Pin Number | Description                                  |
|-----------------|------------|--|
| N/C             | 1          | Not connected (Note 5)                       |
| RF in           | 2          | RF in port (Note 1)                          |
| Data            | 3          | Serial Interface data input (Note 3)         |
| Clock           | 4          | Serial Interface clock input                 |
| LE              | 5          | Latch Enable Input (Note 2)                  |
| V <sub>DD</sub> | 6          | Power Supply                                 |
| N/C             | 7          | Not connected                                |
| N/C             | 8          | Not connected                                |
| V <sub>DD</sub> | 9          | Power Supply                                 |
| GND             | 10         | Ground connection                            |
| GND             | 11         | Ground connection                            |
| GND             | 12         | Ground connection                            |
| V <sub>DD</sub> | 13         | Power Supply                                 |
| RF out          | 14         | RF out port (Note 1)                         |
| C8              | 15         | Control for attenuation bit, 8 dB (Note 4)   |
| C4              | 16         | Control for attenuation bit, 4 dB (Note 4)   |
| C2              | 17         | Control for attenuation bit, 2 dB (Note 4)   |
| GND             | 18         | Ground Connection                            |
| C1              | 19         | Control for attenuation bit, 1 dB (Note 4)   |
| C0.5            | 20         | Control for attenuation bit, 0.5 dB (Note 4) |
| GND             | Paddle     | Paddle ground (Note 6)                       |

## Pin Configuration (Top View)

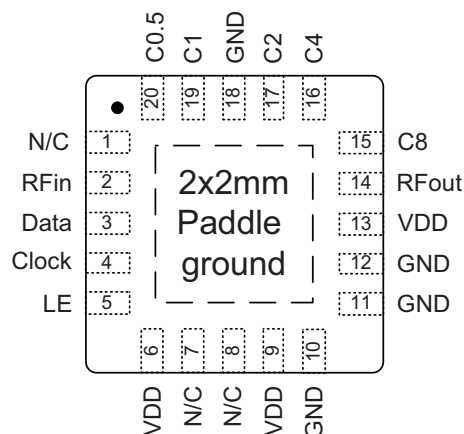

### Notes:

- Both RF ports must be held at 0VDC or DC blocked with an external series capacitor.
- Latch Enable (LE) has an internal 100KΩ resistor to V<sub>DD</sub>.
- Place a 10KΩ resistor in series, as close to pin as possible to avoid freq. resonance.
- Refer to Power-up Control Settings.
- Place a shunt 10KΩ resistor to GND.
- The exposed solder pad on the bottom of the package (see Pin configuration) must be grounded for proper device operation.

# Digital Step Attenuator

## Typical Performance Curves

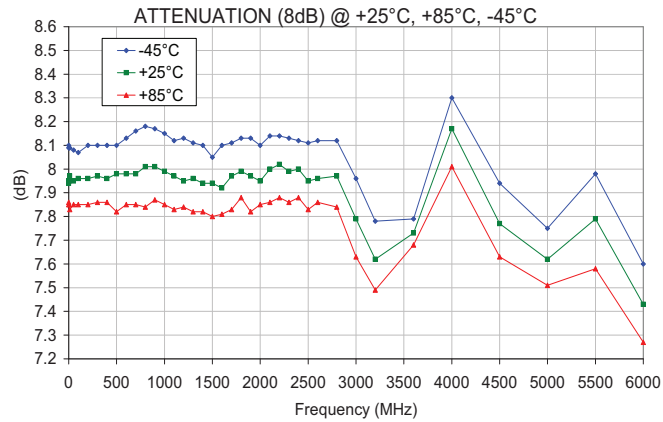
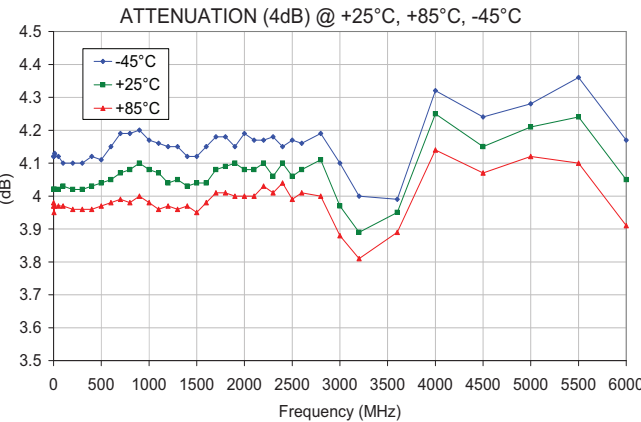
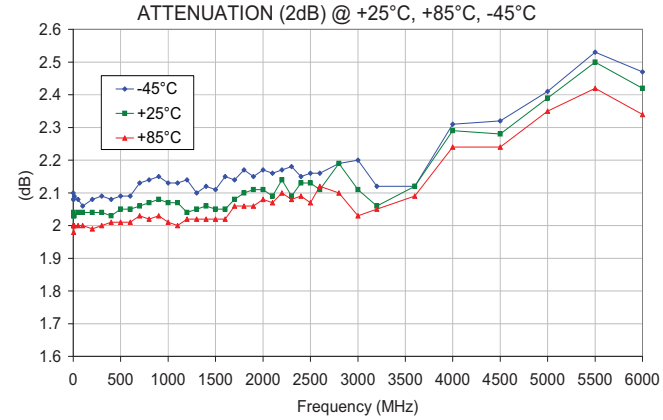
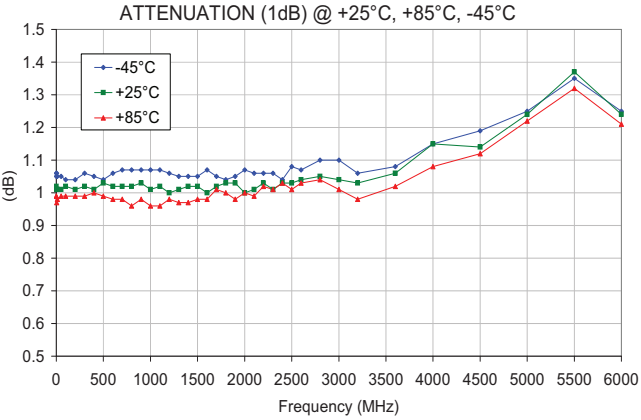
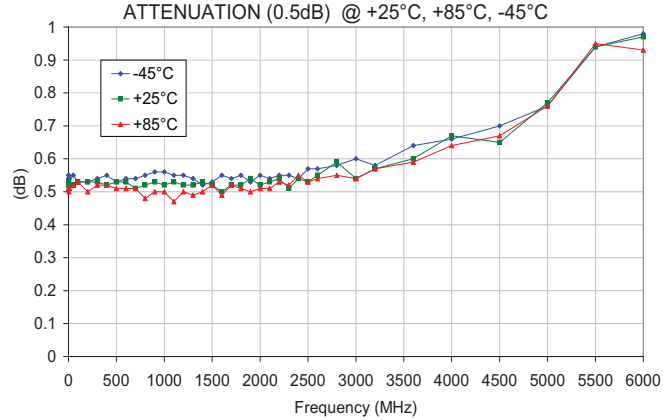
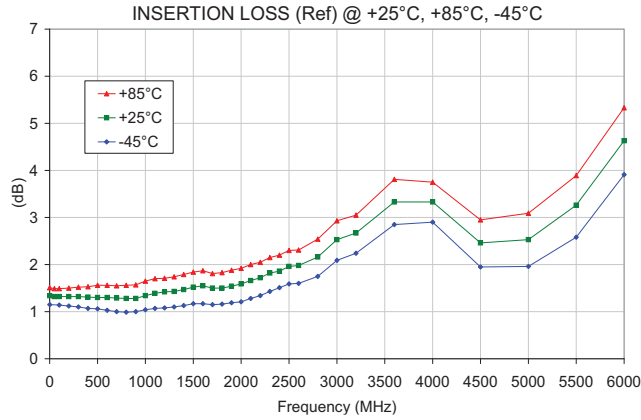

For detailed performance specs & shopping online see web site

P.O. Box 350166, Brooklyn, New York 11235-0003 (718) 934-4500 Fax (718) 332-4661 [The Design Engineers Search Engine](http://www.minicircuits.com) Provides ACTUAL Data Instantly at [minicircuits.com](http://www.minicircuits.com)

**Notes:** 1. Performance and quality attributes and conditions not expressly stated in this specification sheet are intended to be excluded and do not form a part of this specification sheet. 2. Electrical specifications and performance data contained herein are based on Mini-Circuit's applicable established test performance criteria and measurement instructions. 3. The parts covered by this specification sheet are subject to Mini-Circuits standard limited warranty and terms and conditions (collectively, "Standard Terms"); Purchasers of this part are entitled to the rights and benefits contained therein. For a full statement of the Standard Terms and the exclusive rights and remedies thereunder, please visit Mini-Circuits' website at [www.minicircuits.com/MCLStore/terms.jsp](http://www.minicircuits.com/MCLStore/terms.jsp).

# Digital Step Attenuator

**DAT-15R5-SP+**  
**DAT-15R5-SP**

## Typical Performance Curves

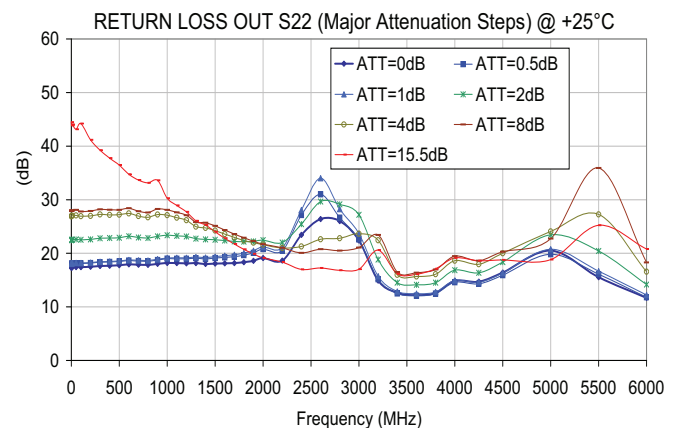
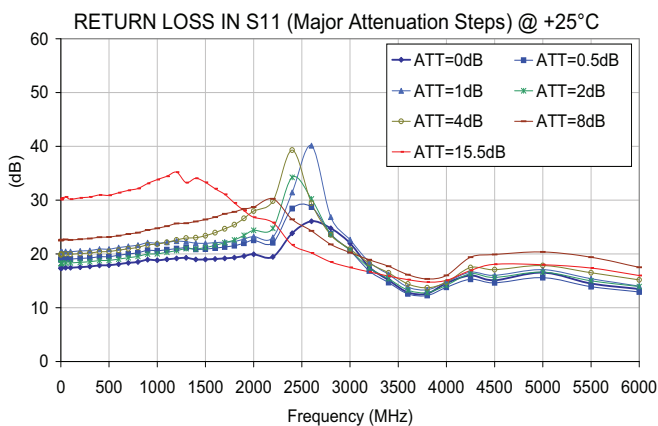
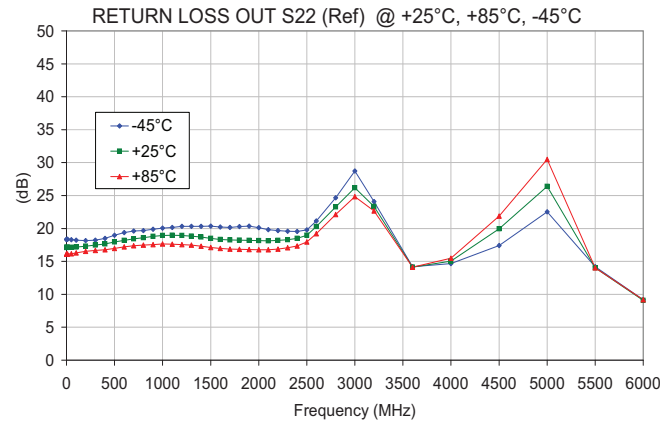
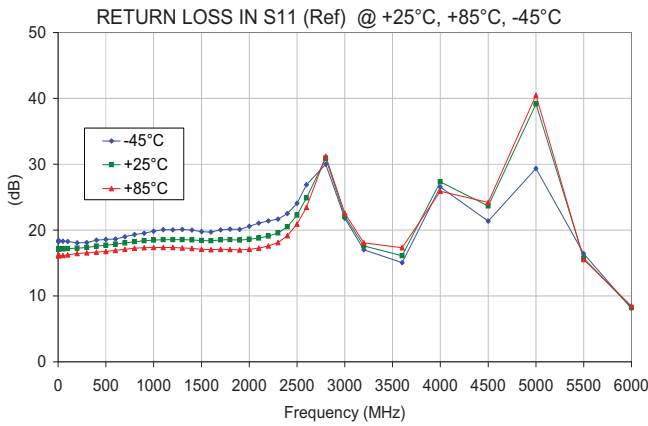
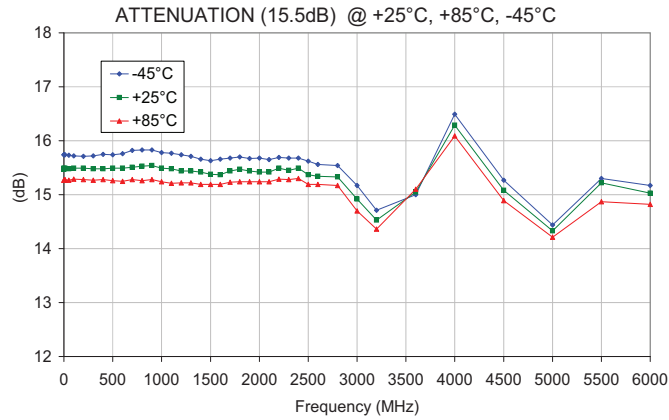

**Mini-Circuits®**  
ISO 9001 ISO 14001 AS 9100 CERTIFIED  
P.O. Box 350166, Brooklyn, New York 11235-0003 (718) 934-4500 Fax (718) 332-4661 The Design Engineers Search Engine Provides ACTUAL Data Instantly at [minicircuits.com](http://minicircuits.com)  
IF/RF MICROWAVE COMPONENTS

For detailed performance specs  
& shopping online see web site

Notes: 1. Performance and quality attributes and conditions not expressly stated in this specification sheet are intended to be excluded and do not form a part of this specification sheet. 2. Electrical specifications and performance data contained herein are based on Mini-Circuit's applicable established test performance criteria and measurement instructions. 3. The parts covered by this specification sheet are subject to Mini-Circuits standard limited warranty and terms and conditions (collectively, "Standard Terms"); Purchasers of this part are entitled to the rights and benefits contained therein. For a full statement of the Standard Terms and the exclusive rights and remedies thereunder, please visit Mini-Circuits' website at [www.minicircuits.com/MCLStore/terms.jsp](http://www.minicircuits.com/MCLStore/terms.jsp).

# Digital Step Attenuator

## Typical Performance Curves

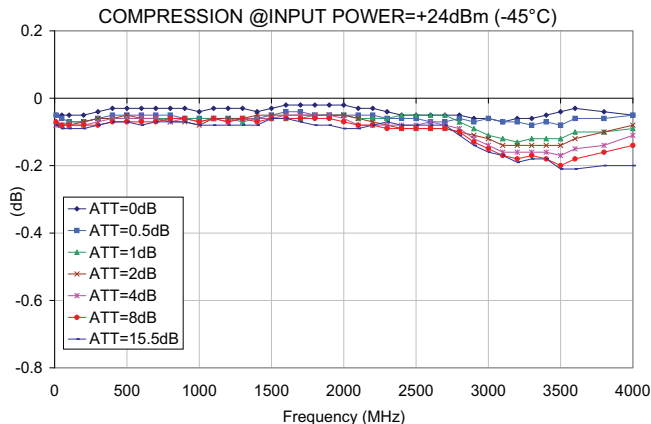
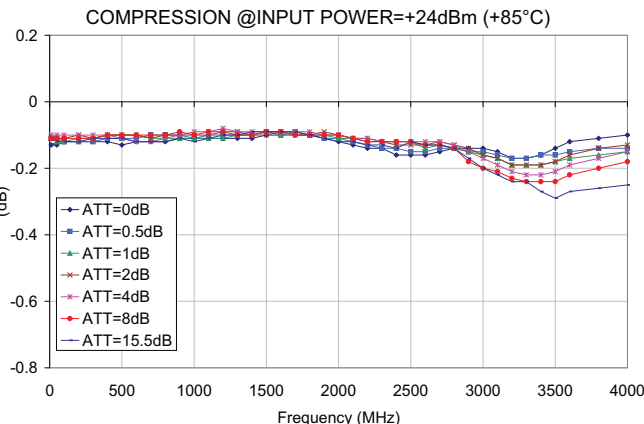
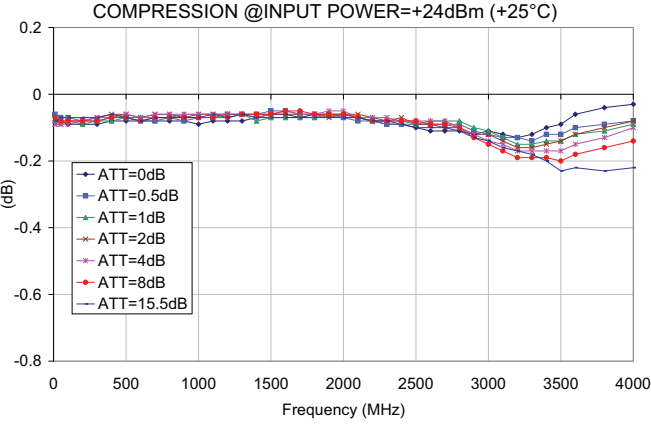
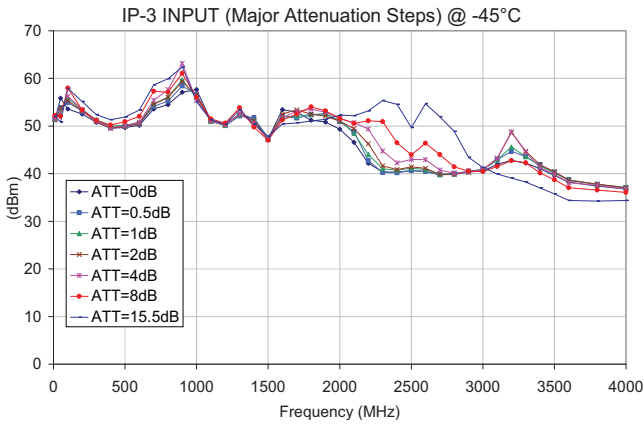
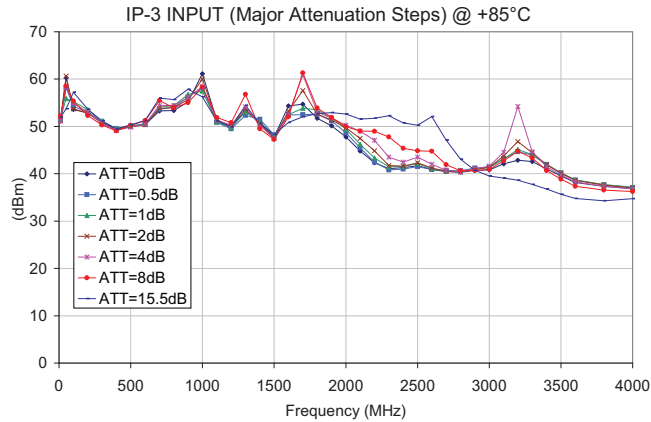
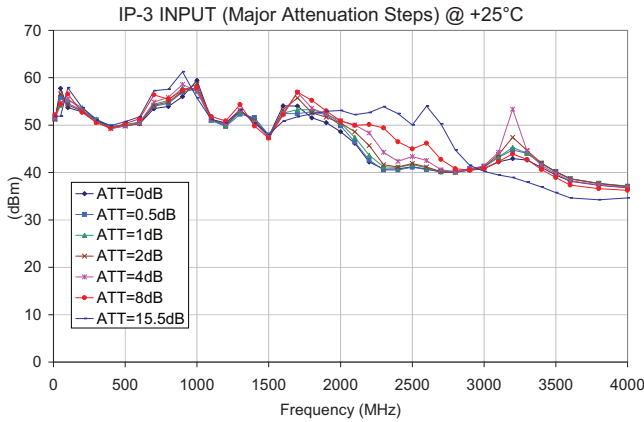

For detailed performance specs & shopping online see web site

P.O. Box 350166, Brooklyn, New York 11235-0003 (718) 934-4500 Fax (718) 332-4661 The Design Engineers Search Engine Provides ACTUAL Data Instantly at [minicircuits.com](http://minicircuits.com)

IF/RF MICROWAVE COMPONENTS

Notes: 1. Performance and quality attributes and conditions not expressly stated in this specification sheet are intended to be excluded and do not form a part of this specification sheet. 2. Electrical specifications and performance data contained herein are based on Mini-Circuit's applicable established test performance criteria and measurement instructions. 3. The parts covered by this specification sheet are subject to Mini-Circuits standard limited warranty and terms and conditions (collectively, "Standard Terms"); Purchasers of this part are entitled to the rights and benefits contained therein. For a full statement of the Standard Terms and the exclusive rights and remedies thereunder, please visit Mini-Circuits' website at [www.minicircuits.com/MCLStore/terms.jsp](http://www.minicircuits.com/MCLStore/terms.jsp).

## Outline Drawing (DG983-1)

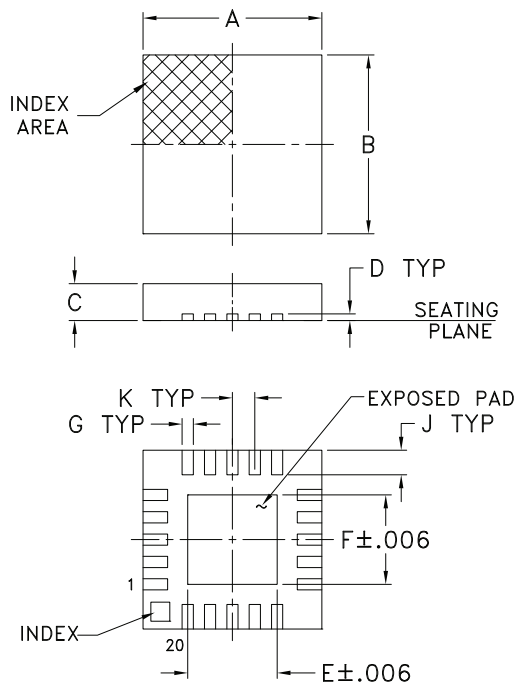

## PCB Land Pattern

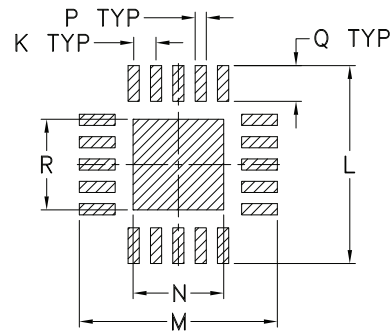

Suggested Layout,  
Tolerance to be within  $\pm .002$

## Device Marking

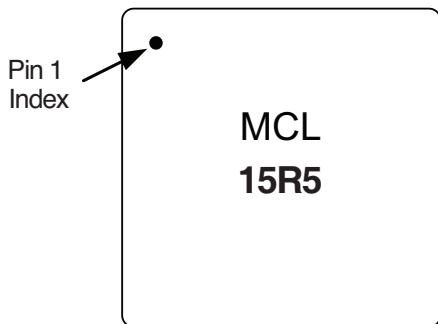

## Outline Dimensions (inch/mm)

| A    | B    | C    | D    | E    | F    | G    | H | J    | K    | L    | M    | N    | P    | Q    | R    | WT. GRAMS |
|------|------|------|------|------|------|------|---|------|------|------|------|------|------|------|------|-----------|
| .157 | .157 | .035 | .008 | .081 | .081 | .010 | — | .022 | .020 | .177 | .177 | .081 | .010 | .032 | .081 | .04       |
| 4.00 | 4.00 | 0.90 | 0.20 | 2.06 | 2.06 | 0.25 | — | 0.56 | 0.50 | 4.50 | 4.50 | 2.06 | 0.25 | 0.81 | 2.06 |           |

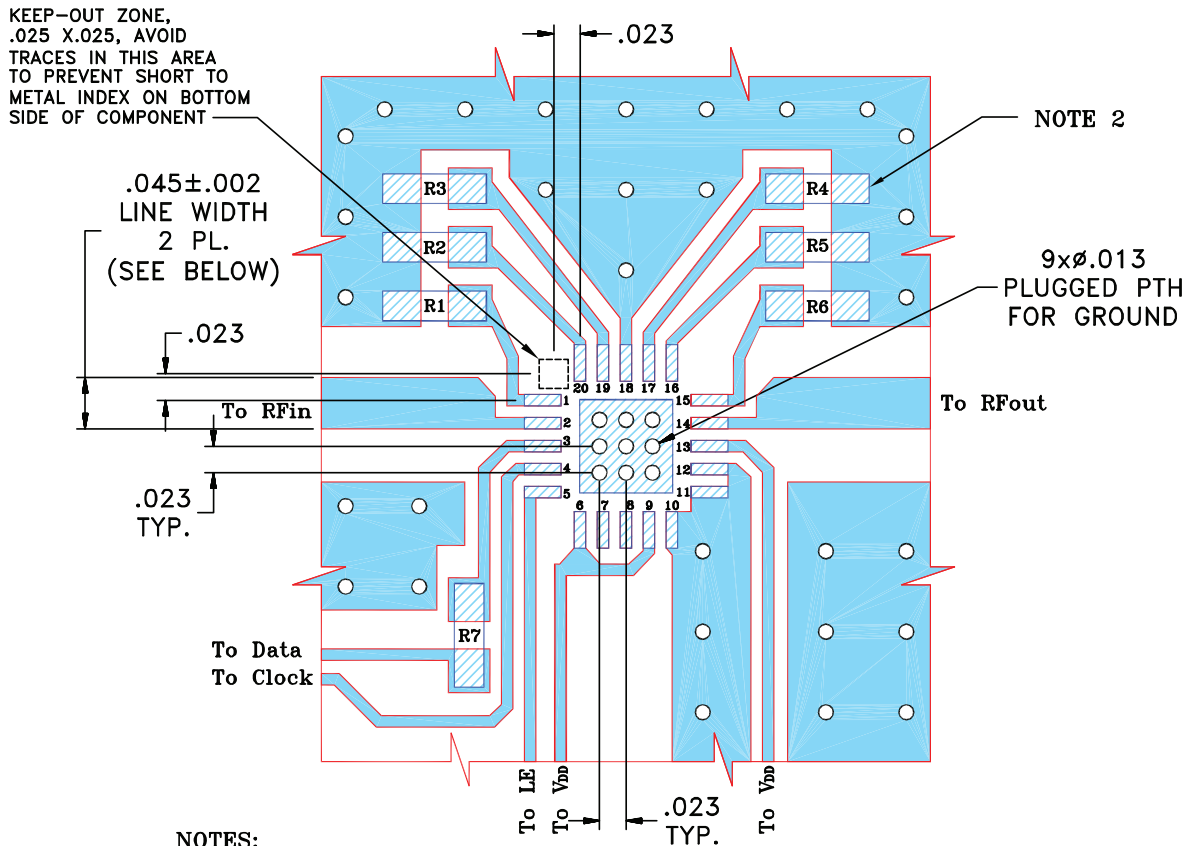

## Suggested Layout for PCB Design (PL-199)

The suggested Layout shows only the footprint area of the DAT, and the components located near this area (i.e.: R1-R7). For the complete Layout, see photo and schematic diagram on page 11 of 12.



### NOTES:

1. TRACE WIDTH IS SHOWN FOR FR4 WITH DIELECTRIC THICKNESS .025"±.002". COPPER: 1/2 OZ. EACH SIDE. FOR OTHER MATERIALS TRACE WIDTH MAY NEED TO BE MODIFIED.
2. 0603 SIZE CHIP FOOT PRINTS SHOWN FOR REFERENCE, VALUES OF RESISTORS WILL VARY BASED ON APPLICATION.
3. BOTTOM SIDE OF THE PCB IS CONTINUOUS GROUND PLANE.

-  DENOTES PCB COPPER LAYOUT WITH SMOBC (SOLDER MASK OVER BARE COPPER)
-  DENOTES COPPER LAND PATTERN FREE OF SOLDER MASK

# Digital Step Attenuator

## Simplified Schematic

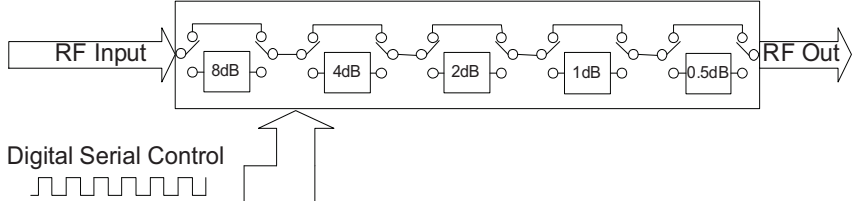

The DAT-15R5-SP Serial interface consists of 5 control bits that select the desired attenuation state, as shown in Table 1: Truth Table

| Attenuation State | C8 | C4 | C2 | C1 | C0.5 |
|-------------------|----|----|----|----|------|
| Reference         | 0  | 0  | 0  | 0  | 0    |
| 0.5 (dB)          | 0  | 0  | 0  | 0  | 1    |
| 1 (dB)            | 0  | 0  | 0  | 1  | 0    |
| 2 (dB)            | 0  | 0  | 1  | 0  | 0    |
| 4 (dB)            | 0  | 1  | 0  | 0  | 0    |
| 8 (dB)            | 1  | 0  | 0  | 0  | 0    |
| 15.5 (dB)         | 1  | 1  | 1  | 1  | 1    |

Note: Not all 32 possible combinations of C0.5 - C8 are shown in table

The serial interface is a 5-bit serial in, parallel-out shift register buffered by a transparent latch.

It is controlled by three CMOS-compatible signals: Data, Clock, and Latch Enable (LE). The Data and Clock inputs allow data to be serially entered into the shift register, a process that is independent of the state of the LE input.

The LE input controls the latch. When LE is HIGH, the latch is transparent and the contents of the serial shift register control the attenuator. When LE is brought LOW, data in the shift register is latched.

The shift register should be loaded while LE is held LOW to prevent the attenuator value from changing as data is entered. The LE input should then be toggled HIGH and brought LOW again, latching the new data. The timing for this operation is defined by **Figure 1** (Serial Interface Timing Diagram) and **Table 2** (Serial Interface AC Characteristics).

**Figure 1: Serial Interface Timing Diagram**

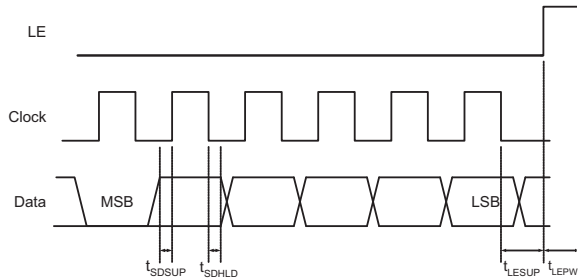

| Symbol      | Parameter  | Min. | Max. | Units |
|-------------|--|------|------|-------|
| $f_{clk}$   | Serial data clock frequency (Note 1)             |      | 10   | MHz   |
| $t_{clkH}$  | Serial clock HIGH time                           | 30   |      | ns    |
| $t_{ClkL}$  | Serial clock LOW time                            | 30   |      | ns    |
| $t_{LESUP}$ | LE set-up time after last clock falling edge     | 10   |      | ns    |
| $t_{LEPW}$  | LE minimum pulse width                           | 30   |      | ns    |
| $t_{SDSUP}$ | Serial data set-up time before clock rising edge | 10   |      | ns    |
| $t_{SDHLD}$ | Serial data hold time after clock falling edge   | 10   |      | ns    |

Note 1. fclk verified during the functional pattern test. Serial programming sections of the functional pattern are clocked at 10MHz to verify fclk specification.



For detailed performance specs & shopping online see web site

P.O. Box 350166, Brooklyn, New York 11235-0003 (718) 934-4500 Fax (718) 332-4661 The Design Engineers Search Engine Provides ACTUAL Data Instantly at [minicircuits.com](http://minicircuits.com)

**Notes:** 1. Performance and quality attributes and conditions not expressly stated in this specification sheet are intended to be excluded and do not form a part of this specification sheet. 2. Electrical specifications and performance data contained herein are based on Mini-Circuit's applicable established test performance criteria and measurement instructions. 3. The parts covered by this specification sheet are subject to Mini-Circuits standard limited warranty and terms and conditions (collectively, "Standard Terms"); Purchasers of this part are entitled to the rights and benefits contained therein. For a full statement of the Standard Terms and the exclusive rights and remedies thereunder, please visit Mini-Circuits' website at [www.minicircuits.com/MCLStore/terms.jsp](http://www.minicircuits.com/MCLStore/terms.jsp).

# Digital Step Attenuator

The DAT-15R5-SP, uses a common 5-bit serial word format, as shown in **Table 3**: 5-Bit attenuator Serial Programming Register Map.

The second bit B4 corresponds to the 8-dB Step and the last bit B0 corresponds to the 0.5 dB step.

| B5 | B4 | B3 | B2 | B1 | B0   |
|----|----|----|----|----|------|
| 0  | C8 | C4 | C2 | C1 | C0.5 |

↑  
MSB  
(first in)
↑  
LSB  
(last in)

**Note: The start bit (B5) must always be low to prevent the attenuator from entering an unknown state.**

### Power-up Control Settings

The DAT-15R5-SP always assumes a specifiable attenuation setting on power-up, allowing a known attenuation state to be established before an initial serial control word is provided.

When the attenuator powers up, the five control bits are set to whatever data is present on the five data inputs (C0.5 to C8).

This allows any one of the 32 attenuation settings to be specified as the power-up state.

# Digital Step Attenuator

**DAT-15R5-SP+**  
**DAT-15R5-SP**

## TB-334 Evaluation Board Schematic Diagram

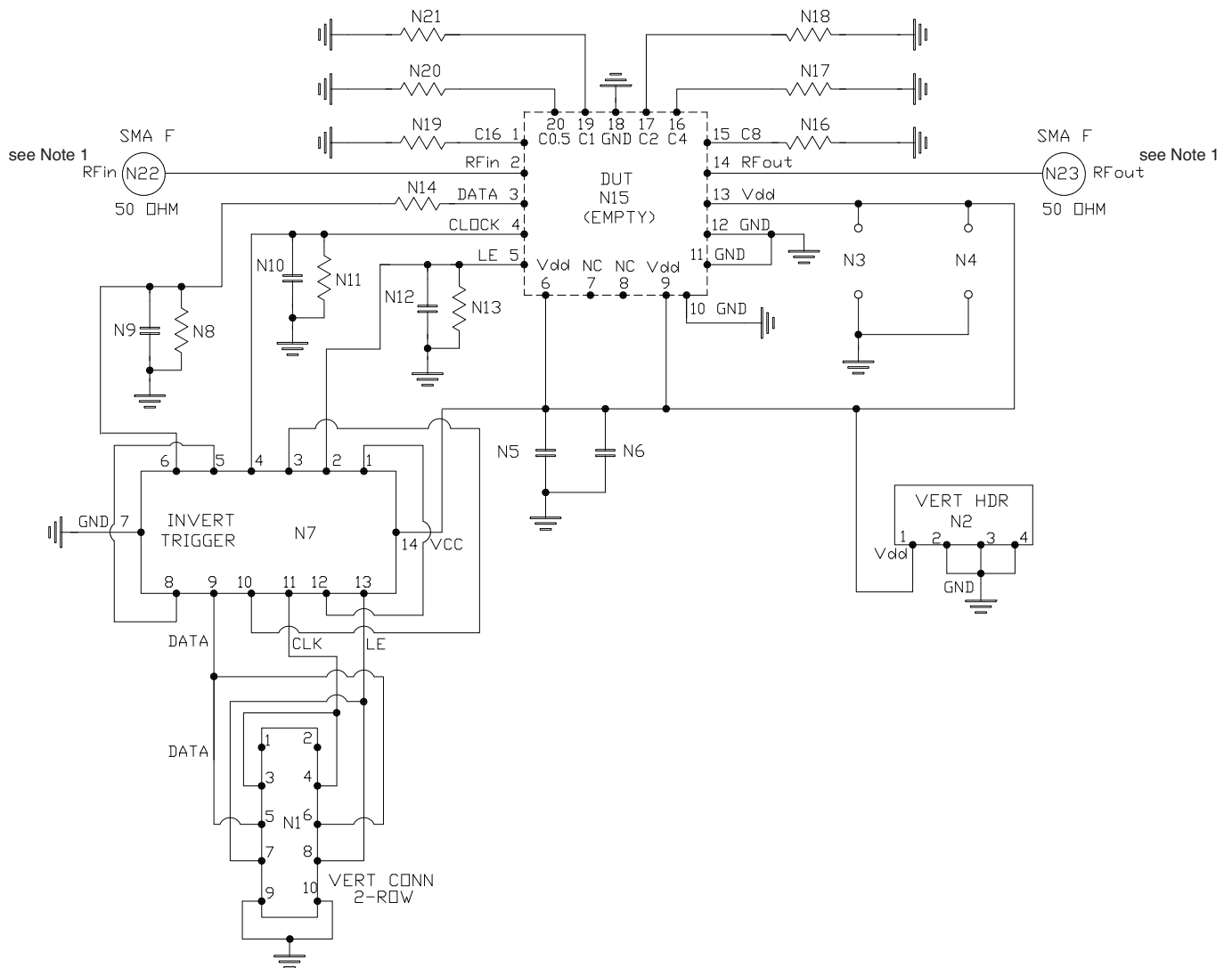

Note 1: Both RF ports must be held at 0VDC or DC blocked with an external series capacitor.

| Bill of Materials          |                                       |
|----------------------------|---------------------------------------|
| N8, N11, N13, N14, N16-N21 | Resistor 0603 10 KOhm +/- 1%          |
| N5, N9, N10 & N12          | NPO Capacitor 0603 100pF +/- 5%       |
| N6                         | Tantalum Capacitor 0805 100nF +/- 10% |
| N7                         | Hex Invert Schmitt Trigger MSL1       |

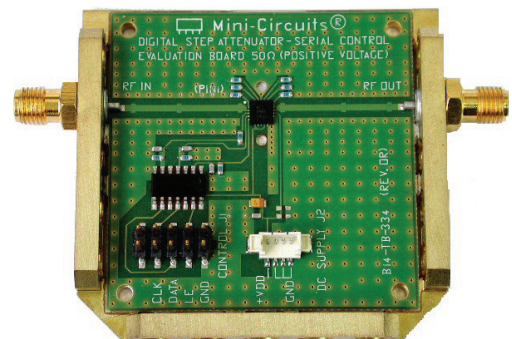

**TB-334**

**Mini-Circuits®**  
ISO 9001 ISO 14001 AS 9100 CERTIFIED

For detailed performance specs & shopping online see web site

P.O. Box 350166, Brooklyn, New York 11235-0003 (718) 934-4500 Fax (718) 332-4661 The Design Engineers Search Engine Provides ACTUAL Data Instantly at [minicircuits.com](http://minicircuits.com)

IF/RF MICROWAVE COMPONENTS

Notes: 1. Performance and quality attributes and conditions not expressly stated in this specification sheet are intended to be excluded and do not form a part of this specification sheet. 2. Electrical specifications and performance data contained herein are based on Mini-Circuit's applicable established test performance criteria and measurement instructions. 3. The parts covered by this specification sheet are subject to Mini-Circuits standard limited warranty and terms and conditions (collectively, "Standard Terms"); Purchasers of this part are entitled to the rights and benefits contained therein. For a full statement of the Standard Terms and the exclusive rights and remedies thereunder, please visit Mini-Circuits' website at [www.minicircuits.com/MCLStore/terms.jsp](http://www.minicircuits.com/MCLStore/terms.jsp). Page 11 of 12

## Tape and Reel Packaging Information

**Table T&R**

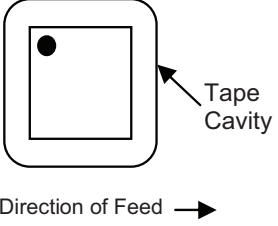
| TR No. | No. of Devices                             | Reel Size      | Tape Width | Pitch | Unit Orientation  |
|--------|--|----------------|------------|-------|---|
| F87    | 3000                                       | 13 inch        | 12 mm      | 8 mm  |  |
|        | multiples of 10, less than full reel of 3K | 13 inch        |            |       |   |
|        | multiples of 10, on tape only              | not applicable |            |       |   |

## Ordering Information

| Model No.       | Description                               | Quantity Min. No. of Units | Price \$ Ea. |
|-----------------|---|----------------------------|--------------|
| DAT-15R5-SP (+) | Serial Interface, Single Positive Voltage | 10                         | \$3.55       |
| TB-334          | Test Board Only                           | 1                          | \$79.95      |